

2-channel BTL driver for CD players

BA6295AFP

The BA6295AFP is a 2-channel BTL driver for CD player actuators and motors. This IC delivers a large output current and is ideal for car CD players.

●Applications

CD players

●Features

- 1) 2-channel BTL driver.
- 2) High output current. ($I_o = I_A$ Typ.)
- 3) HSOP 28-pin package allows for miniaturization of applications.
- 4) Internal thermal shutdown.
- 5) Gain is adjustable by inserting a resistor between pins 27 and 28 ; pins 18 and 16.

●Absolute maximum ratings ($T_a = 25^\circ\text{C}$)

Parameter	Symbol	Limits	Unit
Power supply voltage	V_{cc}	22	V
Power dissipation	P_d	1.7*	W
Operating temperature	T_{opr}	$-30 \sim +85$	$^\circ\text{C}$
Storage temperature	T_{stg}	$-55 \sim +150$	$^\circ\text{C}$

* Reduced by 13.6 mW for each increase in T_a of 1°C over 25°C .
When mounted on a $50 \times 50 \times 1.0$ mm paper phenol board

●Recommended operating conditions ($T_a = 25^\circ\text{C}$)

Parameter	Symbol	Min.	Typ.	Max.	Unit
Operating power supply voltage	V_{cc}	7.5	—	18*	V

* Set the power supply voltage according to power dissipation.

● Block diagram

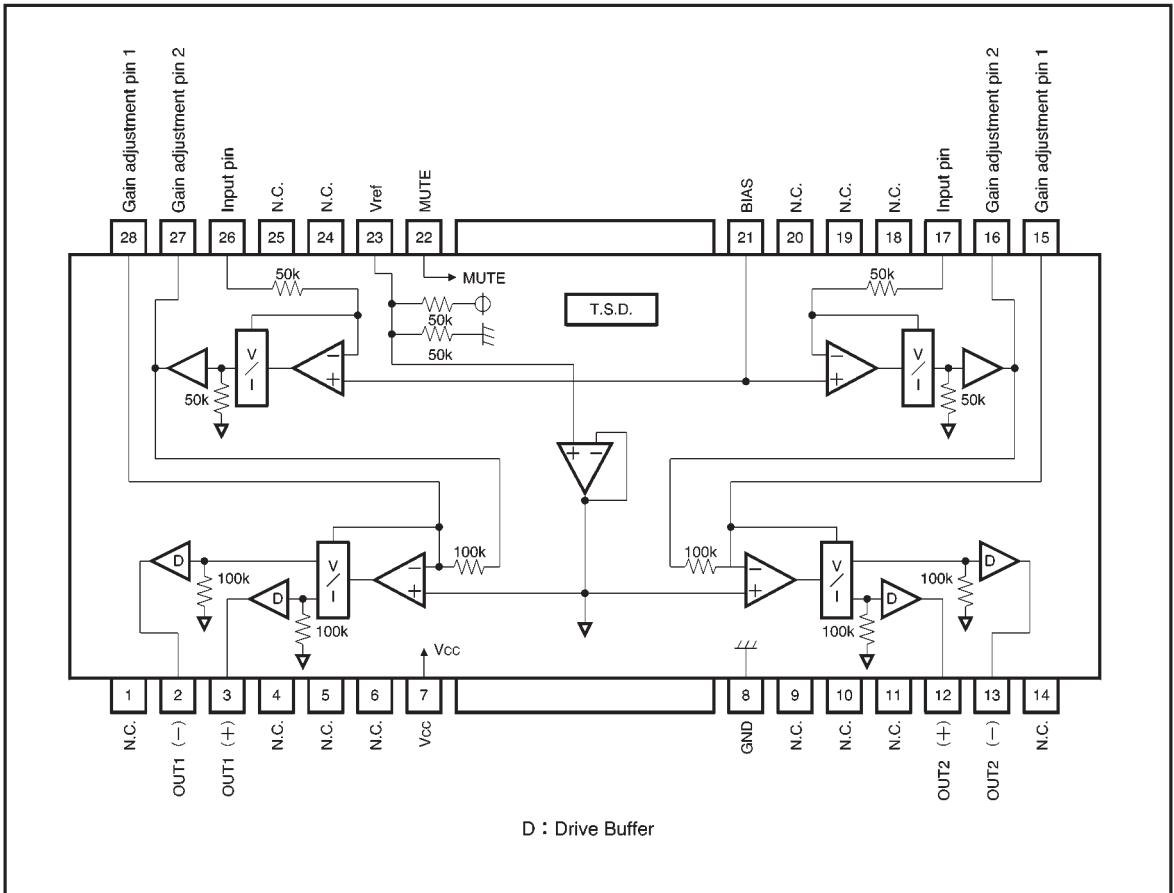
● Electrical characteristics (unless otherwise noted, $T_a = 25^\circ\text{C}$, $V_{CC} = 10\text{V}$, $f = 1\text{kHz}$)

Parameter	Symbol	Min.	Typ.	Max.	Unit	Conditions	Measurement Circuit
Quiescent current dissipation	I_{CC}	3.4	5.2	7	mA	No load	Fig.5
Output offset voltage	V_{OO}	-30	0	30	mV		Fig.5
Maximum output current 1	I_{SO}	1	-	-	A	GND output at $R_L = 4 \Omega$	Fig.5
Maximum output current 2	I_{SI}	1	-	-	A	V_{CC} output at $R_L = 4 \Omega$	Fig.5
Maximum output amplitude	V_{OM}	3.2	3.6	-	V_{RMS}	$V_{IN} = 2V_{RMS}$, 1kHz	Fig.5
Closed loop voltage gain	G_{VC}	-	5.0	-	dB	$V_{IN} = 1V_{RMS}$, 1kHz	Fig.5
Cutoff frequency	f_C	-	40	-	kHz	$V_{IN} = 1V_{RMS}$, 3dB DOWN	Fig.5
Crosstalk	CT	60	80	-	dB	$V_{IN} = 1V_{RMS}$, 1kHz,	Fig.5
Ripple rejection	RR	50	70	-	dB	$V_{IN} = 0.1V_{RMS}$, 100Hz	Fig.5
Slew rate	SR	-	0.5	-	$V / \mu\text{s}$	$V_{IN} = 1V_{P-P}$	Fig.5
Bias pin voltage	V_{BI}	-	5.0	-	V		Fig.5

©Not designed for radiation resistance.

●Electrical characteristic curves

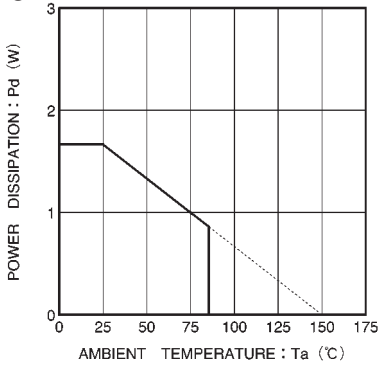

Fig. 1 Thermal derating curve

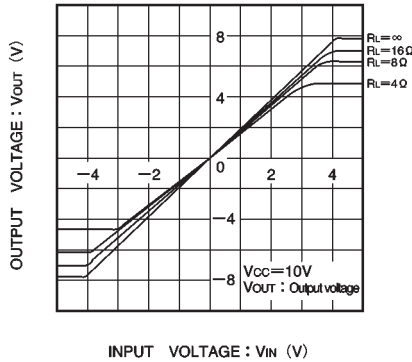

Fig. 2 I/O characteristics (variable load)

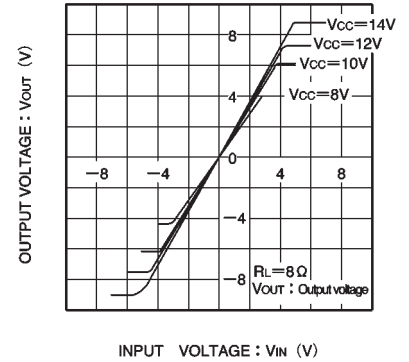

Fig. 3 I/O characteristics (variable supply voltage)

●Measurement circuit

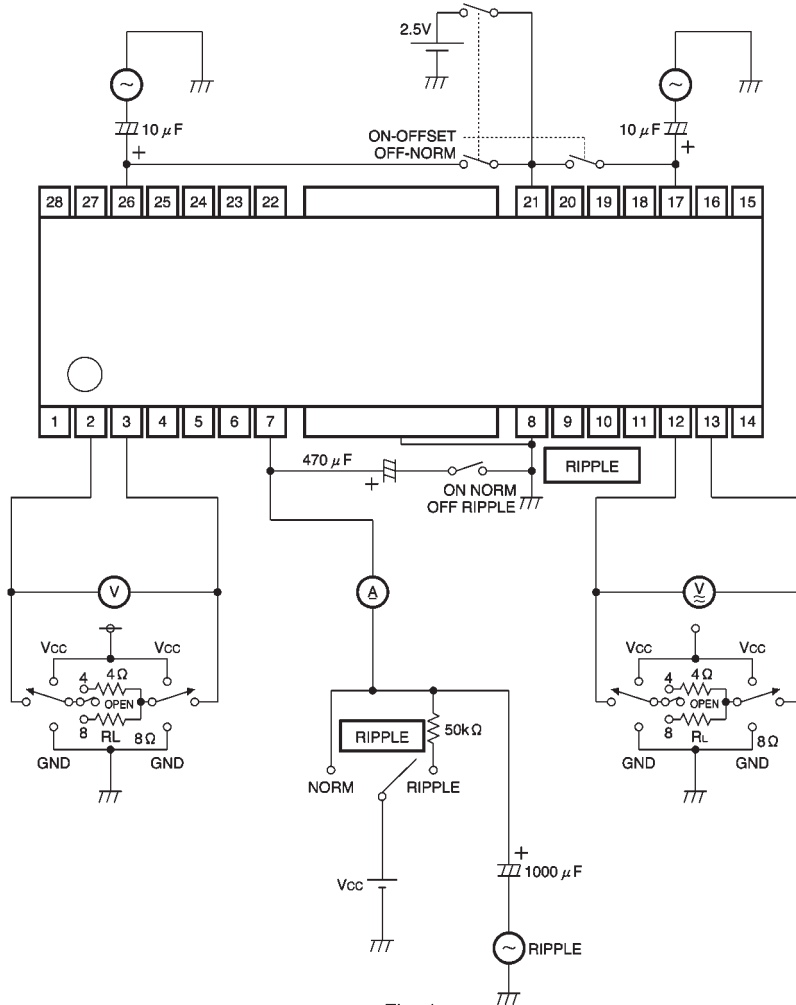

Fig. 4

● Circuit operation

The BA6295AFP comprises a 2-channel driver, internal bias amplifier, mute pin, and thermal shutdown circuit.

(1) Driver

The input resistance of the driver is the focus tracking error signal from the servo preamplifier and the control signal from the motor. The input signals normally center on 2.5V, and are converted to a $V_{CC}/2$ -centered signal by the internal level shift amplifier.

Both positive and negative phases are created during final V/I conversion, generating BTL output via the driver buffer. Because the gain adjustment pins (pins 15, 16, 27 and 28) are external, gain can be adjusted by connecting a resistor in parallel.

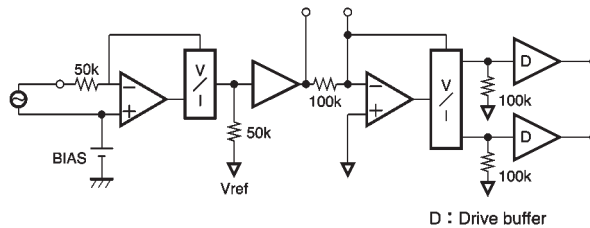

Fig. 5 The driver block

(2) Internal bias amplifier

This IC's internal bias is $1/2 V_{CC}$. Ripple rejection can be increased and crosstalk reduced by connecting a capacitor to pin 23.

(3) Mute pins

The output current can be muted by switching one of these pins to the HIGH level. These pins are also used for thermal shutdown and should always remain at high impedance during normal operations. This is because the thermal shutdown feature is disabled when these pins are at the LOW level.

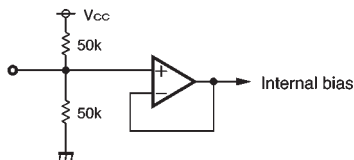

Fig. 6 The internal bias amplifier

● Operation notes

(1) The BA6295AFP has an internal thermal shutdown circuit. Output current is muted when the chip temperature exceeds 190°C (typically).

(2) Output current can but muted by raising the voltage between pins 22 and 8 above 1.5V.

(3) Shorting pins 22 and 8 disables the thermal shutdown feature.

(4) Be sure to connect the IC to a 0.1μF bypass capacitor to the power supply, at the base of the IC.

(5) The radiating fin is connected to the package's internal GND (pin 8), but both it and pin 8 should also be connected to an external ground.

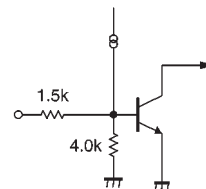

Fig. 7 A mute pin

●Application example

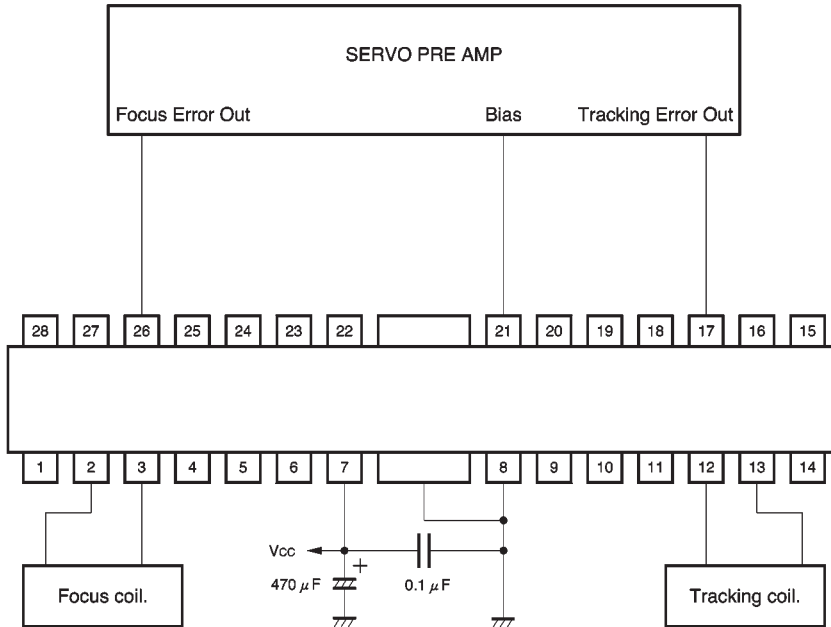

Fig. 8

●External dimensions (Units: mm)

