

1.1GHz-band PLL IC for Mobile Communications

Descriptions

The CXA1786N is a frequency synthesizer PLL IC developed for use in mobile communication systems. This IC has low current consumption, small package and is suitable for portable sets of cellular telephone and others.

Features

- Low current consumption
 $I_{cc} = 6.0\text{mA}$ (typ.)
 0.3mA (typ.) in power saving mode
- Maximum operating frequency
 1.1GHz guaranteed
- Operating supply voltage range
 2.7 to 5.5V
- Ultra small 20-pin SSOP package
- Two types of phase comparator output:
 For external charge pump ϕR ϕP
 Two internal charge pumps Do1 Do2

Applications

1.1GHz-band mobile communication equipment such as cellular telephones

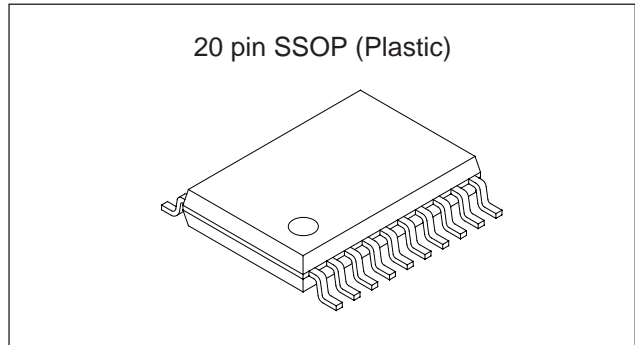

Structure

Bipolar silicon monolithic IC

Absolute Maximum Ratings

• Supply voltage	V_{cc}	7	V
• Operating temperature	T_{opr}	-35 to +85	°C
• Storage temperature	T_{stg}	-65 to +150	°C
• Allowable power dissipation	P_D	300	mW

Operating Condition

Supply voltage	V_{cc}	2.7 to 5.5	V
----------------	----------	------------	---

Block Diagram and Pin Configuration

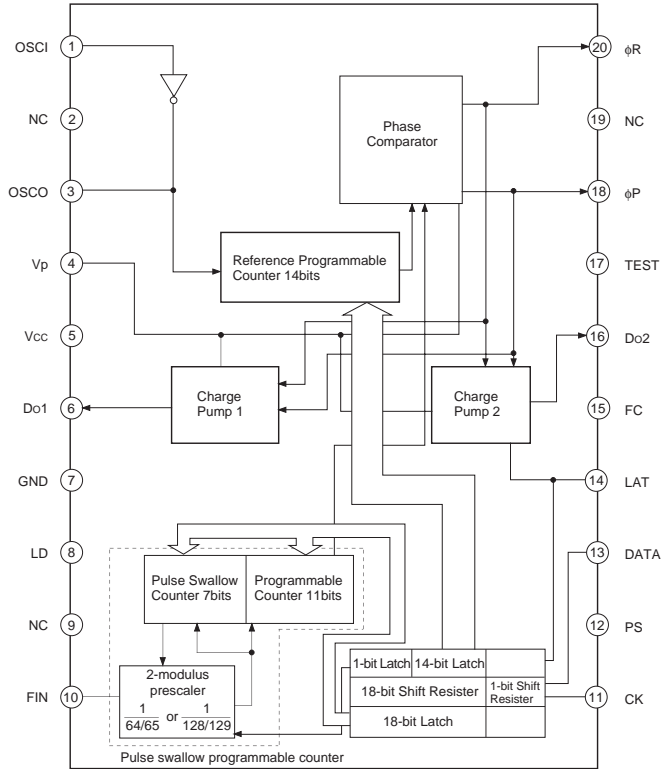

Sony reserves the right to change products and specifications without prior notice. This information does not convey any license by any implication or otherwise under any patents or other right. Application circuits shown, if any, are typical examples illustrating the operation of the devices. Sony cannot assume responsibility for any problems arising out of the use of these circuits.

Pin Description

Pin No.	Symbol	Typical pin voltage (DC)	Equivalent circuit	Description
1	OSCI	2.2V		Reference frequency signal input.
10	FIN			VCO signal input.
2	NC	—	—	No connected.
9				
19				
3	OSCO	High: 2.2V Low: 2.0V		Reference frequency signal output. Oscillator is formed by connecting the crystal resonator between this pin and the OSCI pin; the oscillator signal is used as the reference frequency signal.
4	V _P	3V	—	Power supply for the charge pump outputs (Do1, Do2) and phase comparator outputs (φ _R , φ _P).
5	V _{CC}	3V	—	Power supply.
6	Do1	—		Charge pump 1 output.
16	Do2			Charge pump 2 output. Outputs only when the LAT pin is High; in high impedance when the LAT pin is Low.
7	GND	—	—	Ground.
8	LD	High: 2.2V Low: 0.1V		Lock detection signal output.
18	φ _P			Phase comparator output. Used for the external charge pump.
20	φ _R			
11	CK	Open Low		Clock input.
13	DATA			Data input.
14	LAT			Latch input.

Pin No.	Symbol	Typical pin voltage (DC)	Equivalent circuit	Description
12	PS	Open High		Power saving pin. Power saving mode when this pin is Low.
15	FC			Switching for the phases of phase comparator output and the output signals of counter (reference, programmable) output to the TEST pin.
17	TEST	High: 2.2V Low: 2.0V		The signal output which is frequency-divided at the counter.

Electrical Characteristics ($V_{CC} = V_P = 3V$, $T_a = 25^\circ C$, refer to the Electrical Characteristics Measurement Circuit)

Item	Symbol	Conditions	Min.	Typ.	Max.	Unit
Current consumption	I _{CC}			5.84	8.7	mA
Current consumption (in power saving mode)	I _{CC} (PS)			360	510	μA
FIN operating frequency	f _{in}	V _{CC} = V _P = 2.7V to 5.5V T _a = -35°C to +85°C	100		1100	MHz
FIN input level	P _{in}	V _{CC} = V _P = 2.7V to 5.5V T _a = -35°C to +85°C	-10		10	dBm
OSCI operating frequency	f _{osc}	V _{CC} = V _P = 2.7V to 5.5V T _a = -35°C to +85°C	5		20	MHz
OSCI input level	V _{osc}	V _{CC} = V _P = 2.7V to 5.5V T _a = -35°C to +85°C	0.5		2	V _{pp}
Do1 High output current Do2	I _{OH}				-1	mA
Do1 Low output current Do2	I _{OL}		1			mA
Do1 High impedance Do2 leak current (leak current Do2 off)	I _{oz}		-1		1	μA
φR High output voltage φP LD	V _{OH}	I _L = 0.1mA	2	2.18		V
φR Low output voltage φP LD	V _{OL}	I _L = 0.1mA		70.3	500	mV
CK DATA LAT PS	High input voltage	V _{IH}		V _{CC} × 0.7		V
	High input current	I _{OH}	V _{IN} = V _{CC}	-1	1	μA
	Low input voltage	V _{IL}			V _{CC} × 0.3	V
	Low input current	I _{IL}	V _{IN} = GND except for PS	-1	1	μA
PS	Low input current	I _{IL}	V _{IN} = GND	-30	-15.5	μA

	Item	Symbol	Conditions	Min.	Typ.	Max.	Unit
FC	High input voltage	V_{IH}		$V_{CC} - 0.05$			V
	High input current	I_{IH}	$V_{IN} = V_{CC}$	-1		1	μA
	Low input voltage	V_{IL}				0.05	V
	Low input current	I_{IL}	$V_{IN} = GND$	-50	-18.9	1	μA
CK DATA LAT PS	High input voltage	V_{IH}	$V_{CC} = V_P = 5.5V$	$V_{CC} \times 0.7$			V
	High input current	I_{IH}	$V_{CC} = V_P = 5.5V,$ $V_{IN} = V_{CC}$	-1		1	μA
	Low input voltage	V_{IL}	$V_{CC} = V_P = 5.5V$			$V_{CC} \times 0.3$	V
	Low input current	I_{IL}	$V_{CC} = V_P = 5.5V,$ $V_{IN} = GND$ except for PS	-20	0	1	μA
PS	Low input current	I_{IL}	$V_{CC} = V_P = 5.5V,$ $V_{IN} = GND$	-60	-27.7		μA
FC	High input voltage	V_{IH}	$V_{CC} = V_P = 5.5V$	$V_{CC} - 0.05$			V
	High input current	I_{IH}	$V_{CC} = V_P = 5.5V,$ $V_{IN} = V_{CC}$	-1		1	μA
	Low input voltage	V_{IL}	$V_{CC} = V_P = 5.5V$			0.05	V
	Low input current	I_{IL}	$V_{CC} = V_P = 5.5V,$ $V_{IN} = GND$	-60	-34.7	1	μA

Electrical Characteristics Measurement Circuit

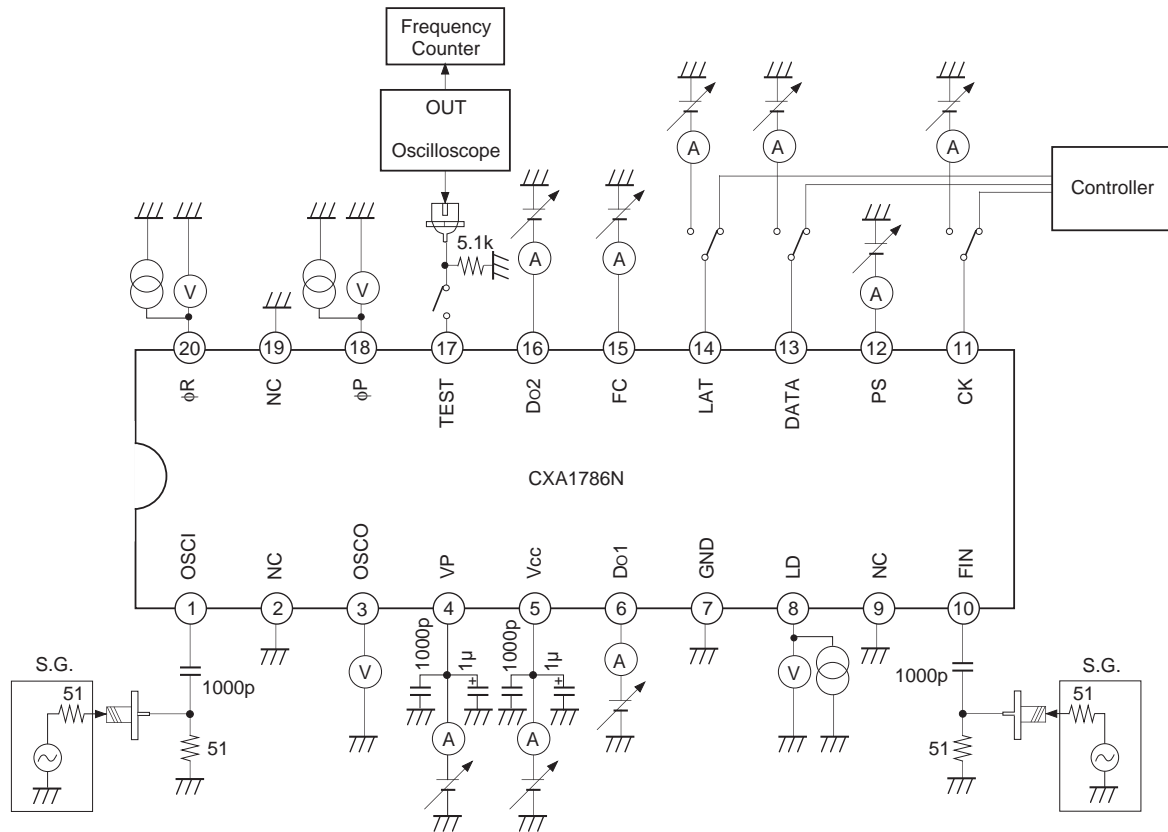

Application Circuit

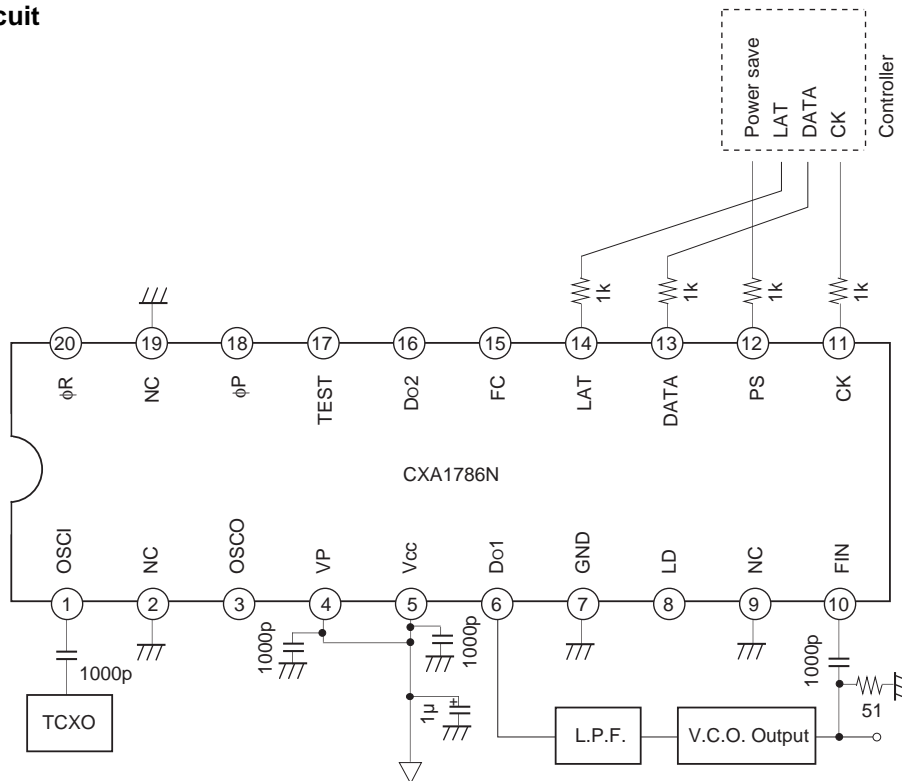

Application circuits shown are typical examples illustrating the operation of the devices. Sony cannot assume responsibility for any problems arising out of the use of these circuits or for any infringement of third party patent and other right due to same.

Description of Operation

1. Data Setting Method

The data is set using three signals — CK, DATA, and LAT in this IC. In that case, the serial data as described below is input.

(1) Data input method

The 15 bits of data should be input to the reference counter latch and the 18 bits of data to the pulse swallow programmable counter latch to set the all initializing state in this IC. Every one bit of data is retrieved into the shift register at the rising edge of clock input to the CK pin when the data is input to the DATA pin. The input data is retrieved into the reference counter latch or the pulse swallow programmable counter latch according to the state of the final bit C.

The data is latched when the latch pulse is input to the LAT pin after 16 bits of data or 19 bits of data, which were added with the bit C, are sent to the shift register.

For actual use, first input the 16 bits (including the frequency division setting bit SW for 2-modulus prescaler) of reference counter data from the controller as indicated above. In this time, set the final bit C High.

Next, input the 19 bits of pulse swallow programmable counter data in the same way. In this time, set the final bit C Low. Then, all of the interior state has been set. Hereafter, when only the programmable counter data is to be changed, only the latter 19 bits of programmable counter data should be changed. (In this case, set the bit C Low.)

(2) Control data construction

The control data consists of 16 bits for the reference counter and 19 bits for the pulse swallow programmable counter. The final bit of them is the identification code and the contents of data are discriminated by identifying the code. The frequency division value is composed of the binary values whose head is MSB as described on the next page.

(a) Data structure of reference counter

Input direction

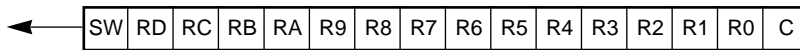

(First, input the SW bit and input the C bit last.)

R0 to RD: Frequency division number of reference counter (Binary value with R0 as LSB)

SW: Switching bit of frequency division numbers of 2-modulus pre-scaler block for programmable counter.

SW	1	0
Frequency division number	64/65-frequency division	128/129-frequency division

C: This code decides the latch direction of data; set to High.

(b) Data structure of pulse swallow programmable counter

Input direction

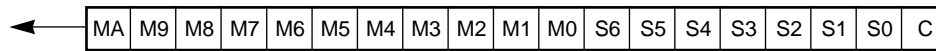

(First, input the MA bit and input the C bit last.)

M0 to MA: Frequency division number of main counter (Binary value with M0 as LSB)

S0 to S6: Frequency division number of swallow counter (Binary value with S0 as LSB)

C: This code decides the latch direction of data; set to Low.

The frequency division value of programmable counter can be obtained with the following equation;

$$N \times M + S$$

N : Frequency division value of 2-modulus pre-scaler (64 or 128)
 $(M > S)$ M : Main counter value
 S : Swallow counter value

(1) Data input timing

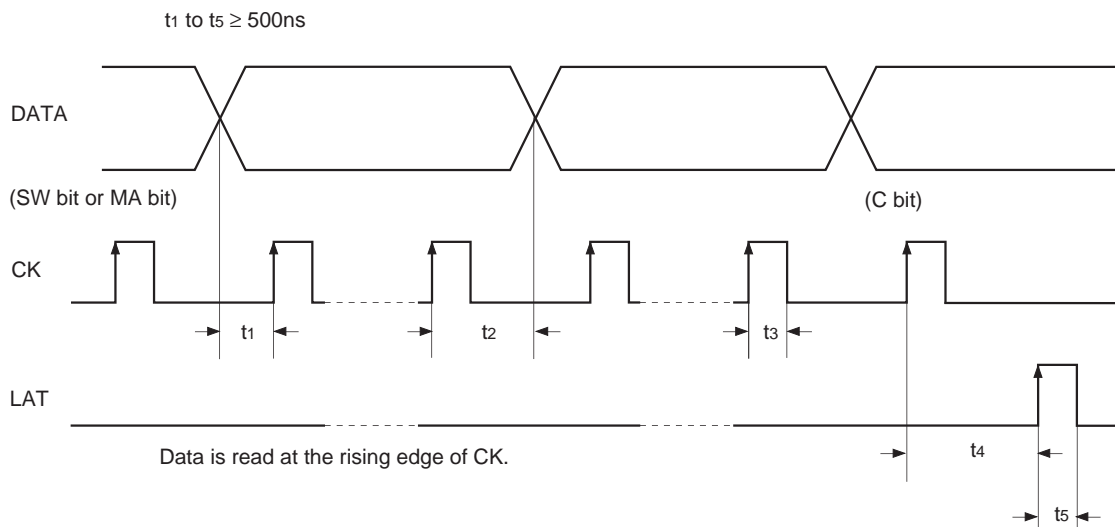

2. Power Save Pin (PS)

This pin is left High when it is open and in power saving mode at Low.

All circuits except for reference counter latch and pulse swallow programmable counter latch are set to off in the power saving mode. At that mode, Do1 and Do2 are high impedance and the data cannot be set.

* The data of reference counter and programmable counter are hold in power saving mode.

3. Do1 and Do2 Pins

These are the charge pump output pins. Do1 operates always. Do2 operates only when the LAT pin is High ; it is in high impedance state when the LAT pin is Low.

4. FC Pin

This pin switches the charge pump outputs (Do1, Do2) and the phases of phase comparator outputs (ϕP , ϕR). (Refer to the Table 1.)

5. TEST Pin

This pin is for monitoring the counter output signal. The reference counter output and the pulse swallow programmable counter output are switched according to the FC state as shown at Table 1.

This pin is emitter follower output High level = $V_{cc} - V_f$ and Low level = $V_{cc} - V_f - 200\text{mV}$ (200mV amplitude).

The DC bias current is decreased to save the power consumption so that the amplitude may not be monitored for monitoring the waveforms with oscilloscope. In that case, connect the TEST pin to ground with an approximately 5k Ω resistor.

Table 1. Phase comparator and TEST Pin outputs

	FC: High or open				FC: Low			
	Do1 (2)	ϕR	ϕP	TEST	Do1 (2)	ϕR	ϕP	TEST
$f_r > f_p$	H	L	L	f_r	L	H	H	f_p
$f_r = f_p$	Z	L	H	f_r	Z	L	H	f_p
$f_r < f_p$	L	H	H	f_r	H	L	L	f_p

* Z: High impedance

f_r : Output frequency of reference counter

H: High

f_p : Output frequency of programmable counter

L: Low

6. Reference signal (the input signal of reference counter)

The external oscillator signal can be used as the reference signal by inputting the signal of the external oscillator to the OSCI pin, and the reference signal can be also generated by connecting the crystal resonator to the OSCI and OSCO pins.

(1) Generation of the reference signal by the external oscillator

Input the signal to the OSCI pin via a capacitor as shown below when the external oscillator signal is use as the reference signal.

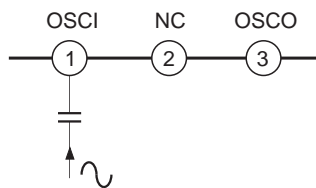

(2) Generation of the reference signal by the built-in oscillator

Connect the crystal resonator between OSCI and OSCO pins as shown below. Use the crystal resonator of several MHz and confirm the stability of the oscillation and others. The capacitance ratio of C_1 and C_0 should be 1 to 2:1, and their values should be selected so that the serial capacitance of C_1 and C_0 may be the load capacitance specified by the crystal vibrator.

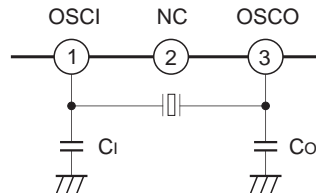

Notes on Operation

- Be careful to use this IC because the electrostatic resistance is the rank "A" due to handling the higher frequency signal of 1GHz
- Make the input route of the RF signal from the VCO as short as possible.
- Connect the V_{cc} and V_p pins to the ground respectively via the by-pass capacitors as short as possible because the frequency of signal used in this IC is higher.

Example of Representative Characteristics

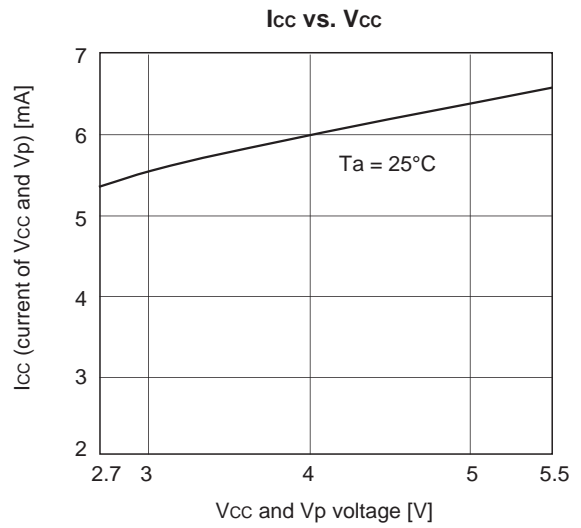
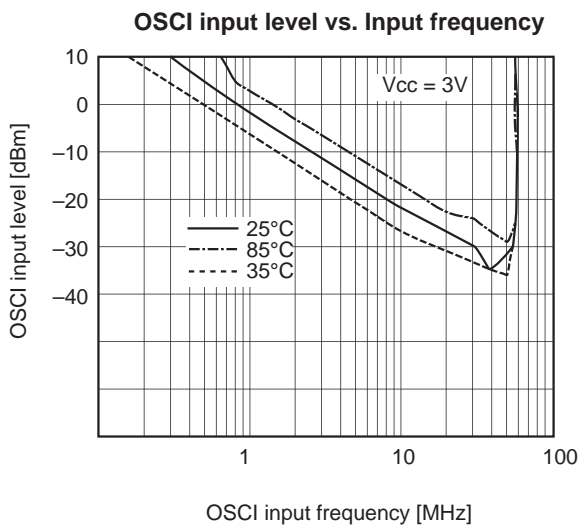
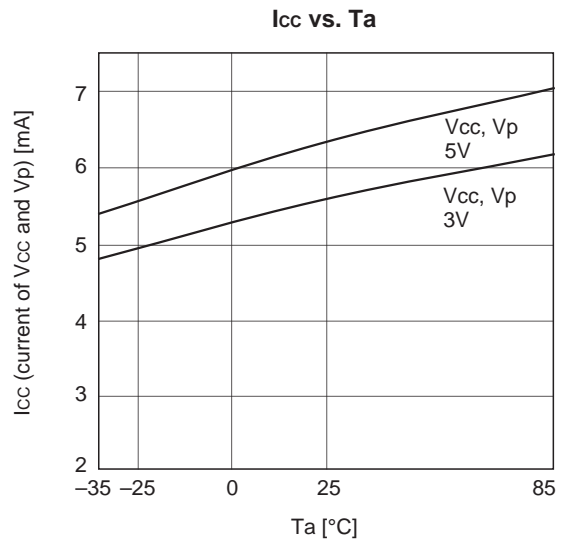
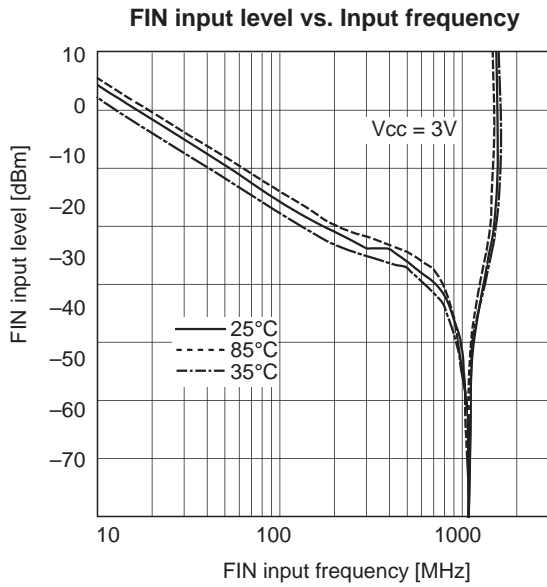

Package Outline Unit: mm

20PIN SSOP (PLASTIC)

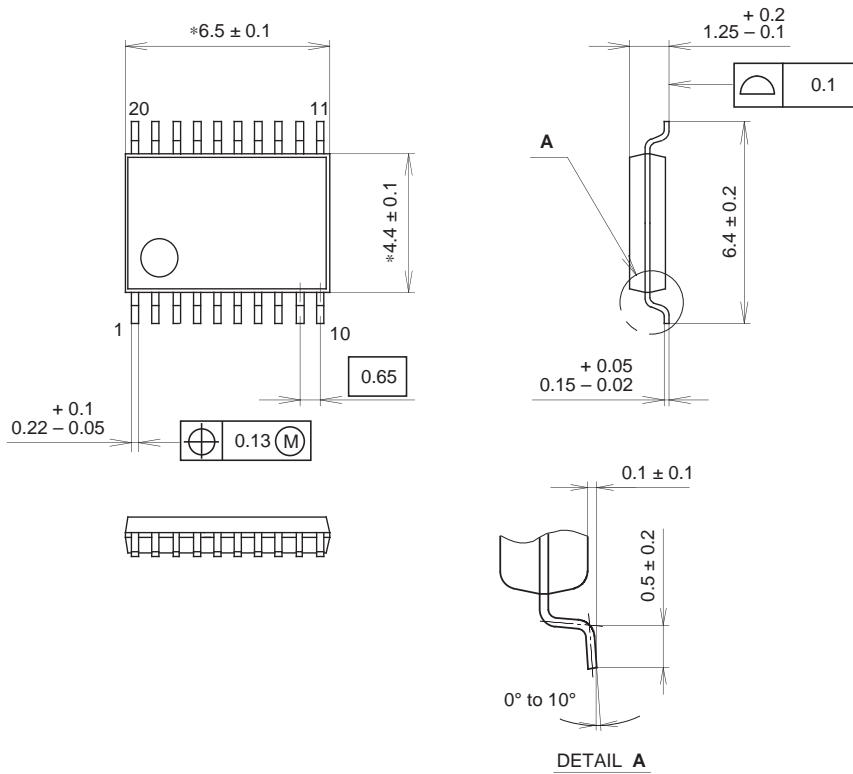

NOTE: Dimension "*" does not include mold protrusion.

PACKAGE STRUCTURE

SONY CODE	SSOP-20P-L01
EIAJ CODE	SSOP020-P-0044
JEDEC CODE	_____

PACKAGE MATERIAL	EPOXY RESIN
LEAD TREATMENT	SOLDER / PALLADIUM PLATING
LEAD MATERIAL	42/COPPER ALLOY
PACKAGE MASS	0.1g

NOTE : PALLADIUM PLATING

This product uses S-PdPPF (Sony Spec.-Palladium Pre-Plated Lead Frame).