MSM66507/66P507

OLMS-66K Series 16-Bit Microcontroller

GENERAL DESCRIPTION

The MSM66507/66P507 is a high-performance 16-bit microcontroller that employs OKI original nX-8/500 CPU core.

The MSM66507/66P507 includes a 16-bit CPU, ROM, RAM, a 10-bit A/D converter, serial ports, flexible timers, a pulse-width modulator (PWM), and I/O ports.

FEATURES

- Program memory space : 64K bytes
 - Internal ROM : 48K bytes
- Data memory space : 64K bytes
 - Internal RAM : 1.5K bytes
- High-speed execution
 - Minimum instruction execution time : 167ns (@24MHz)
- Powerful instruction set : Instruction set superior in orthogonal matrix
 - 8/16-bit data transfer instructions
 - 8/16-bit arithmetic instructions
 - Multiplication and division operation instructions
 - Bit manipulation instructions
 - Bit logic operation instructions
 - ROM table reference instructions
- Abundant addressing modes : Register addressing
 - Page addressing
 - Pointing register indirect addressing
 - Stack addressing
 - Immediate value addressing
- I/O port
 - Analog input port : 1 port × 10 bits
 - Input-output port : 7 ports × 8 bits, 1 port × 3 bits
 - (Each bit can be assigned to input or output.)
- Flexible timers
 - Free run counters : 19-bit × 1, 16-bit × 1
 - 19-bit CAP with a divider : 4
 - 16-bit double buffer RTO : 4
 - 16-bit RTO/PWM : 2
 - 16-bit CAP/RTO : 2
- 8-bit general timer : 1
 - 8-bit event counter : 1
- 16-bit PWM : 4
 - Input clock divider : 2
- Serial ports
 - UART mode with BRG : 1
 - Synchronous/UART switchable mode with BRG : 1
- 10-bit A/D converter : 10 channels

- Transition detector : 6
- Watchdog timer : 1
- Interrupts
 - Nonmaskable : 1
 - Maskable : Internal 28/external 2
 - (4-level priority can be set)
- ROM window function
- Standby modes
 - HALT mode
 - STOP mode
- Package
 - 84-pin plastic QFJ (PLCC) (QFJ84-P-S115-1.27-B) (Product name: MSM66507-xxxJS-B)
 - (Product name: MSM66P507-xxxJS-B)
 - xxx indicates the code number.

BLOCK DIAGRAM

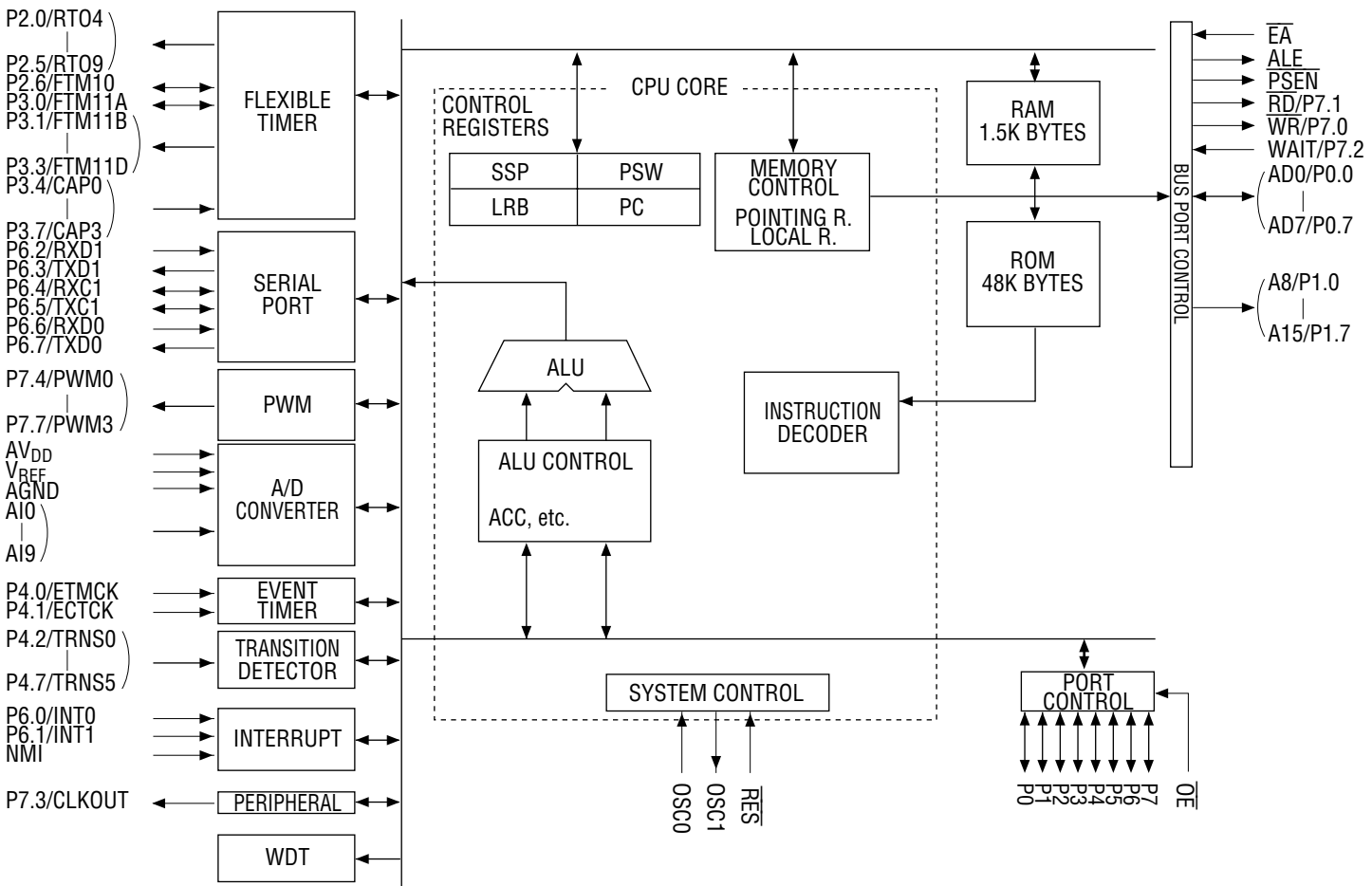

PIN CONFIGURATION (TOP VIEW)

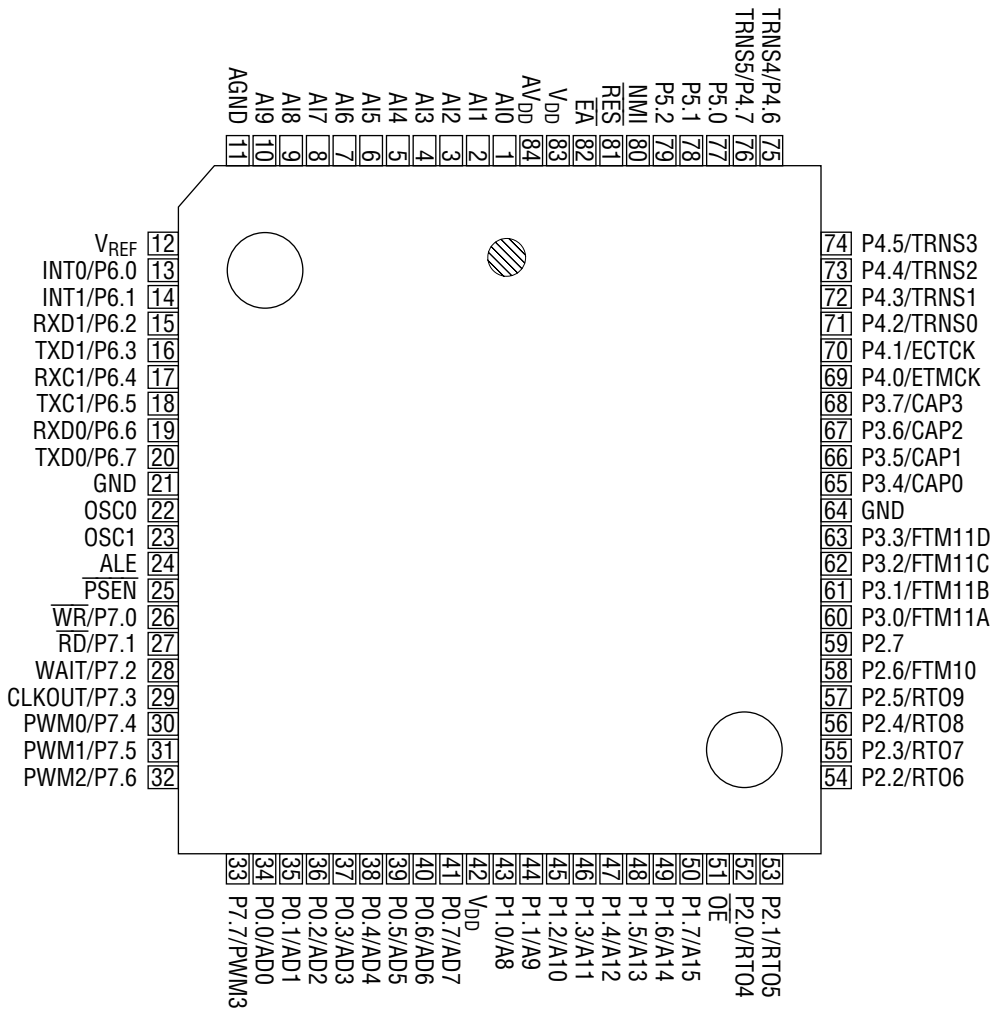

84-Pin Plastic QFJ (PLCC)

PIN DESCRIPTION

Symbol	Type	Description
P0.0-P0.7/ AD0-AD7	I/O	P0: 8-bit Input-output port. Each bit can be assigned to input or output. AD: When an external memory is used, these pins output the lower 8 bits of the address. These pins also input or output the data.
P1.0-P1.7/ A8-A15	I/O	P1: 8-bit Input-output port. Each bit can be assigned to input or output. A: When an external memory is used, these pins output the upper 8 bits of the address.
P2.0-P2.5/ RTO4-RTO9 P2.6/FTM10 P2.7	I/O	P2: 8-bit Input-output port. Each bit can be assigned to input or output. RTO: Output pin for real time output FTM10: Capture input pin or real time output pin
P3.0-P3.3/ FTM11A-FTM11D P3.4-P3.7/ CAP0-CAP3	I/O	P3: 8-bit Input-output port. Each bit can be assigned to input or output. FTM11A: Capture input pin or real time output pin FTM11B-D: 4-port real time output pin CAP : Capture input pin
P4.0/ETMCK P4.1/ECTCK P4.2-P4.7/ TRNS0-TRNS5	I/O	P4: 8-bit Input-output port. Each bit can be assigned to input or output. ETMCK: External clock input pin of 8-bit general timer ECTCK: External clock input pin of 8-bit event counter TRNS: Transition detector input pin
P5.0-P5.2	I/O	P5: 3-bit Input-output port. Each bit can be assigned to input or output.
P6.0/INT0 P6.1/INT1 P6.2/RXD1 P6.3/TXD1 P6.4/RXC1 P6.5/TXC1 P6.6/RXD0 P6.7/TXD0	I/O	P6: 8-bit Input-output port. Each bit can be assigned to input or output. INT0, 1: External interrupt request input pin RXD1 : SCI1 Receiver data input pin TXD1 : SCI1 Transmitter data output pin RXC1 : SCI1 Receiver circuit clock pin TXC1 : SCI1 Transmitter circuit clock pin RXD0 : SCI0 Receiver data input pin TXD0 : SCI0 Transmitter data output pin
P7.0/ \overline{WR} P7.1/ \overline{RD} P7.2/WAIT P7.3/CLKOUT P7.4-P7.7/ PWM0-PWM3	I/O	P7: 8-bit Input-output port. Each bit can be assigned to input or output. \overline{WR} : Write strobe output pin for external data memory \overline{RD} : Road strobe output pin for external data memory WAIT: CPU wait request input pin when accessing external data memory CLKOUT: Output pin for supplying a clock to peripheral circuits PWM: PWM output pin
AI0-AI9	I	Analog signal input only pin for A/D converter
AV _{DD}	I	Power supply input pin for A/D converter
V _{REF}	I	Reference voltage input pin for A/D converter
AGND	I	GND input pin for A/D converter
OSC0	I	Basic clock oscillation pin
OSC1	O	Basic clock oscillation pin

PIN DESCRIPTION (Continued)

Symbol	Type	Description
ALE	O	Timing pulse output pin to latch the lower 8 bits of the address output from port 0 when the CPU accesses the external memory
$\overline{\text{PSEN}}$	O	Strobe pulse output pin to fetch to external program memory
$\overline{\text{OE}}$	I	Normally, when P0, P1, and P7.4-P7.7 are in an output state and the $\overline{\text{OE}}$ pin is "H" level, the ports go to a high impedance state. When $\overline{\text{OE}}$ pin is "L" level, the ports output "H" or "L" level. However, when P0, P1, and P7.4-P7.7 are in an input state, these ports are not under the influence of $\overline{\text{OE}}$ pin.
NMI	I	Nonmaskable interrupt request input pin
$\overline{\text{RES}}$	I	RESET input pin Low-active reset input pin
$\overline{\text{EA}}$	I	Normally set to "H" level. If set to "L" level, the program memory goes to external access mode and accesses external program memory.
V _{DD}	I	Power supply pin
GND	I	Ground pin

REGISTERS

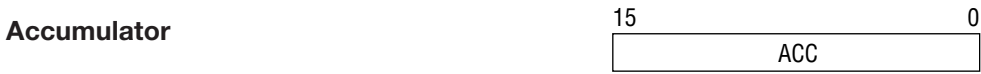

- Bit 15 : Carry flag (CY)
- Bit 14 : Zero flag (ZF)
- Bit 13 : Half carry flag (HC)
- Bit 12 : Data descriptor (DD)
- Bit 11 : Sign flag (S)
- Bit 10 : Master interrupt priority flag (MIP)
- Bit 9 : Overflow flag (OV)
- Bit 8 : Master interrupt enable flag (MIE)
- Bit 7-3 : User flag
- Bit 2-0 : System control base 2-0 (SCB2-0)



Pointing Register (PR)

- Index Register 1
- Index Register 2
- Data pointer
- User Stack Pointer

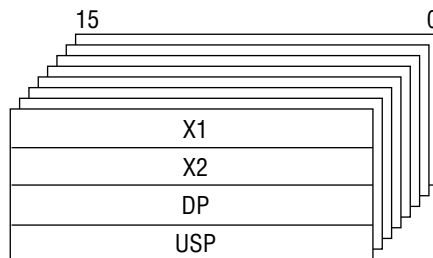

Local Register

	7	0	7	0
ER0	R1		R0	
ER1	R3		R2	
ER2	R5		R4	
ER3	R7		R6	

SFR

Address [H]	Name	Symbol	R/W	8/16-bit Operation	Reset		
0000	System stack pointer	SSP	R/W	8/16	FF		
0001					FF		
0002	Local register base	LRBL			8	Undefined	
0003		LRBH					
0004	Program status word	PSWL				00	
0005		PSWH				00	
0006	Accumulator	ACCL				00	
0007		ACCH				00	
0010	ROM window register	ROMWIN				00	
0011☆	RAM ready control register	RAMRDY				FF	
0012☆	ROM ready control register	ROMRDY				FF	
0014	Stop code acceptor	STPACP				W	"0"
0015☆	Standby control register	SBYCON				R/W	C8
0018☆	Peripheral control register	PRPHF					*
001C	Watchdog timer	WDT		W		Halt	
001D☆	TBC Clock dividing counter	TBCKDVC		R		F0	
001E☆	TBC Clock dividing register	TBCKDVR			F0		
0020	Port 0 data register	P0		R/W	8/16	00	
0021	Port 1 data register	P1				00	
0022	Port 2 data register	P2				00	
0023	Port 3 data register	P3				00	
0024	Port 4 data register	P4				00	
0025☆	Port 5 data register	P5				F8	
0026	Port 6 data register	P6				00	
0027	Port 7 data register	P7				00	
0028	Port 0 mode register	P0IO				00	
0029	Port 1 mode register	P1IO				00	
002A	Port 2 mode register	P2IO				00	
002B	Port 3 mode register	P3IO	00				
002C	Port 4 mode register	P4IO	00				
002D☆	Port 5 mode register	P5IO	F8				
002E	Port 6 mode register	P6IO	00				
002F	Port 7 mode register	P7IO	00				

Note: A ☆ mark in the address column shows that there is a bit that does not exist in its register.

- * The initial values of PRPHF (SFR=18H) are as follows :
 When $\overline{\text{RES}}$ pin is reset : VBFF (bit 6) is set to "1" and CKOUT1 and 0 are set to "0".
 When reset by the WDT or BRK instruction or by operation code trap : VBFF (bit 6) keeps the value just before reset and CKOUT 1 and 0 are set to "0". In any cases, the state of the $\overline{\text{OE}}$ pin is read for OERD (bit 7).

SFR (Continued)

Address [H]	Name	Symbol	R/W	8/16-bit Operation	Reset	
0031	Port 1 secondary function control register	P1SF	R/W	8	00	
0032☆	Port 2 secondary function control register	P2SF		8/16	80	
0033	Port 3 secondary function control register	P3SF		8	00	
0034	Port 4 secondary function control register	P4SF		8/16	00	
0036	Port 6 secondary function control register	P6SF			00	
0037	Port 7 secondary function control register	P7SF			00	
0038	TRNS control register 0	TRNSCON0			00	
0039☆	TRNS control register 1	TRNSCON1		8	F0	
003A☆	Transition detector	TRANSIT		8	C0	
0040	Interrupt request register 0	IRQ0L		8/16	00	
0041		IRQ0H			00	
0042	Interrupt request register 1	IRQ1L		8	00	
0044	Interrupt enable register 0	IE0L		8/16	00	
0045		IE0H			00	
0046	Interrupt enable register 1	IE1L		8	00	
0048	Interrupt request flag disable register 0	IRQD0L		8/16	00	
0049		IRQD0H			00	
004A	Interrupt request flag disable register 1	IRQD1L		8	00	
004E☆	NMI control register	NMICON		8/16	FC or 7C	
004F☆	External interrupt control register	EXICON			F0	
0050	Interrupt priority control register 00	IP00L			00	
0051		IP00H			00	
0052	Interrupt priority control register 01	IP01L			00	
0053		IP01H			00	
0054	Interrupt priority control register 10	IP10L			8	00
0056	Interrupt priority control register 11	IP11L				00

Note: A ☆ mark in the address column shows that there is a bit that does not exist in its register.

SFR (Continued)

Address [H]	Name	Symbol	R/W	8/16-bit Operation	Reset
0060	SCI0 timer counter	S0TM	R/W	8/16	00
0061	SCI0 timer register	S0TMR			00
0062☆	SCI0 timer control register	S0CON		02	
0063☆	SCI0 transmission control register	ST0CON		82	
0064☆	SCI0 reception control register	SROCON		12	
0065	SCI0 transmission and reception buffer register	SOBUF		Undefined	
0066	SCI0 status register	S0STAT		00	
0068	SCI1 timer counter	S1TM		8/16	00
0069	SCI1 timer register	S1TMR			00
006A☆	SCI1 timer control register	S1CON		8	02
006B☆	SCI1 transmission control register	ST1CON			80
006C	SCI1 reception control register	SR1CON			00
006D	SCI1 transmission and reception buffer register	S1BUF			Undefined
006E	SCI1 status register	S1STAT			00
0070☆	8-bit general timer control register	GTMCON			30
0071	8-bit event counter	GEVC			00
0072	8-bit general timer counter	GTMC			00
0073	8-bit general timer register	GTMR			00
0080	PWR0 buffer register	PW0BF			8/16
0081				00	
0082	PWR1 buffer register	PW1BF		00	
0083				00	
0084	PWR2 buffer register	PW2BF		00	
0085				00	
0086	PWR3 buffer register	PW3BF		00	
0087				00	

Note: A ☆ mark in the address column shows that there is a bit that does not exist in its register.

SFR (Continued)

Address [H]	Name	Symbol	R/W	8/16-bit Operation	Reset	
0098	PWM interrupt control register	PWINTCON	R/W	8	00	
009A	PWM control register 0	PWCON0		8/16	00	
009B	PWM control register 1	PWCON1			00	
009C	PWM clock counter	PWDVC			00	
009D	PWM clock register	PWDVR			00	
009E☆	PWM RUN Register	PWRUN			30	
009F☆	PWM active register	PWACT			F0	
00A0	Timer register 0	TMR0		R/W	16	0000
00A1						0000
00A2	Timer register 1	TMR1				0000
00A3						0000
00A4	Timer register 2	TMR2				0000
00A5						0000
00A6	Timer register 3	TMR3				0000
00A7						0000
00A8	Timer register 4	TMR4				0000
00A9						0000
00AA	Timer register 5	TMR5				0000
00AB					0000	
00AC	Timer register 6	TMR6			0000	
00AD					0000	
00AE	Timer register 7	TMR7			0000	
00AF					0000	
00B0	Timer register 8	TMR8			0000	
00B1					0000	
00B2	Timer register 9	TMR9			0000	
00B3					0000	
00B4	Timer register 10	TMR10	0000			
00B5			0000			
00B6	Timer register 11	TMR11	0000			
00B7			0000			
00B8☆	TMR0 lower 3-bit	TMR0L	8		1F	
00B9☆	TMR1 lower 3-bit	TMR1L			1F	
00BA☆	TMR2 lower 3-bit	TMR2L			1F	
00BB☆	TMR3 lower 3-bit	TMR3L		1F		
00BC	TM setting register	TMSELL	8/16	00		
00BD☆		TMSELH		F0		

Note: A ☆ mark in the address column shows that there is a bit that does not exist in its register.

SFR (Continued)

Address [H]	Name	Symbol	R/W	8/16-bit Operation	Reset
00C0	TMR4 buffer register	TMR4BF	R/W	8/16	00
00C1					00
00C2	TMR5 buffer register	TMR5BF			00
00C3					00
00C4	TMR6 buffer register	TMR6BF			00
00C5					00
00C6	TMR7 buffer register	TMR7BF			00
00C7					00
00C8	Timer control register	TMCON		8	00
00C9☆	Timer counter 0 lower 3-bit	TM0L			1F
00CA	Timer counter 0	TM0		8/16	00
00CB					00
00CC	Timer counter 1	TM1			00
00CD					00
00CE	Capture control register 0	CAPCON0			00
00CF☆	Capture control register 1	CAPCON1			F0
00D0☆	Event control register	EVNTCONL			88
00D1☆		EVNTCONH			88
00D2	TMR mode register	TMRMODE		8	00
00D8☆	Event dividing counter 0	EVDV0		8/16	C0
00D9☆	Event dividing counter 1	EVDV1			C0
00DA☆	Event dividing counter 2	EVDV2			C0
00DB☆	Event dividing counter 3	EVDV3			C0
00DC☆	EVDV0 buffer register	EVDV0BF			C0
00DD☆	EVDV1 buffer register	EVDV1BF	C0		
00DE☆	EVDV2 buffer register	EVDV2BF	C0		
00DF☆	EVDV3 buffer register	EVDV3BF	C0		
00E0	A/DC result register 0	ADCRO	R	*8/16	Undefined
00E1	A/DC result register 1	ADCR1			
00E2	A/DC result register 2	ADCR2			
00E3	A/DC result register 3	ADCR3			
00E4	A/DC result register 4	ADCR4			
00E5	A/DC result register 5	ADCR5			
00E6	A/DC result register 6	ADCR6			
00E7	A/DC result register 7	ADCR7			
00E8	A/DC result register 8	ADCR8			
00E9	A/DC result register 9	ADCR9			
00EA	A/DC result register lower 0	LADCR0	8		
00EB	A/DC result register lower 1	LADCR1			
00EC☆	A/DC result register lower 2	LADCR2			
00ED☆	A/D interrupt control register	ADINTCON			F0
00EE☆	A/DC control register L	ADCONL	R/W		80
00EF☆	A/DC control register H	ADCONH			80

Note: A ☆ mark in the address column shows that there is a bit that does not exist in its register.

* 8/16 means a special word manipulation. (For details, refer to the User's Manual.)

SFR (Continued)

Address [H]	Name	Symbol	R/W	8/16-bit Operation	Reset
00F0☆	RTO control register 0	RTOCON0	R/W	8/16	F8
00F1☆	RTO control register 1	RTOCON1			F8
00F2☆	RTO control register 2	RTOCON2			F8
00F3☆	RTO control register 3	RTOCON3			F8
00F4☆	RTO control register 4	RTOCON4			FC
00F5☆	RTO control register 5	RTOCON5			FC
00F6☆	RTO control register 6	RTOCON6			F8
00F7☆	RTO control register 7	RTOCON7			F8
00F8	RTO control register 8	RTOCON8		8	00
00FE	Emulator using area*				
00FF					

Note: A ☆ mark in the address column shows that there is a bit that does not exist in its register.

* For the emulation using area, if the write is manipulated, the write data becomes invalid, and if the read is manipulated, the read data becomes undefined.

ADDRESSING MODES

The MSM66507/66P507 provides independent 64K-byte data and 64K-byte program spaces with various types of addressing modes. These modes are shown below, for both RAM (for data space) and ROM (for program space).

1. RAM Addressing Mode (for data space)

1.1 Register Addressing

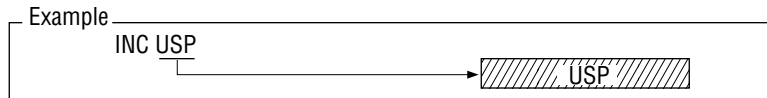

1.2 Page Addressing

a) sfr page

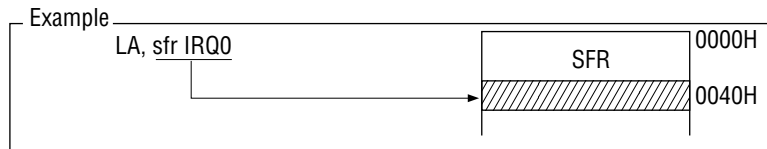

b) Fixed page

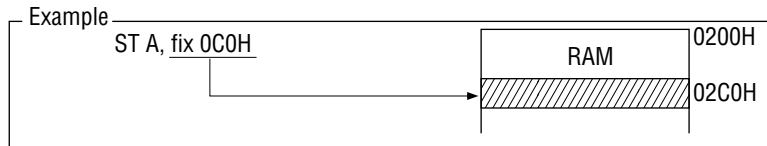

c) Current page

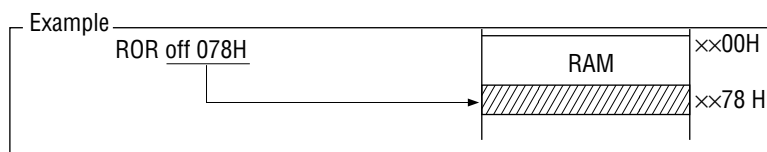

1.3 Direct Data Addressing

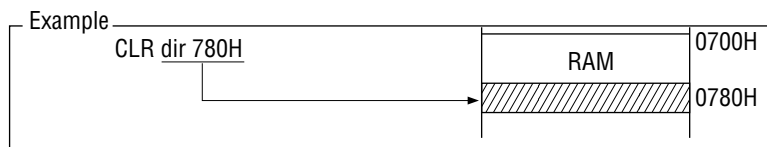

1.4 Pointing Register Indirect Addressing

a) DP/X1 indirect

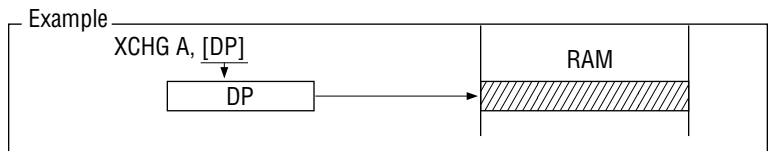

b) Post increment DP indirect

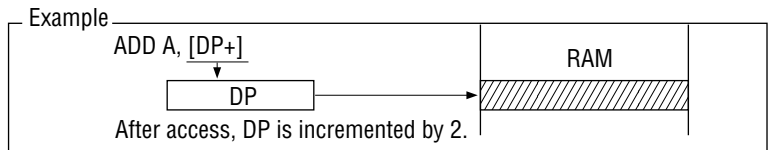

c) Post decrement DP indirect

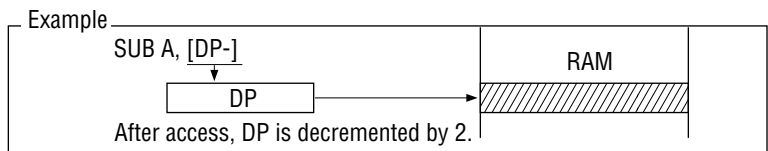

d) DP/USP indirect with 7-bit displacement

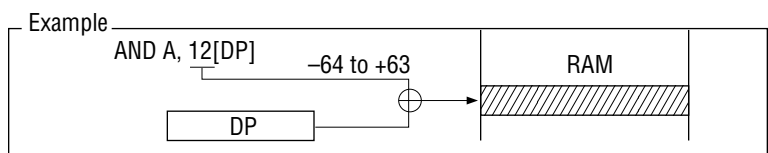

e) X1/X2 indirect with 16-bit base

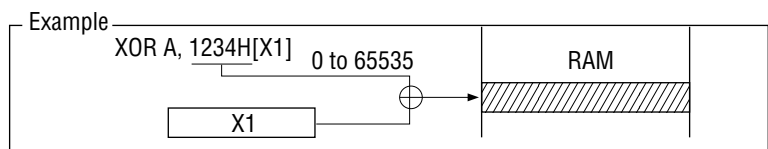

f) X1 indirect with 8-bit register (AL, R0) displacement

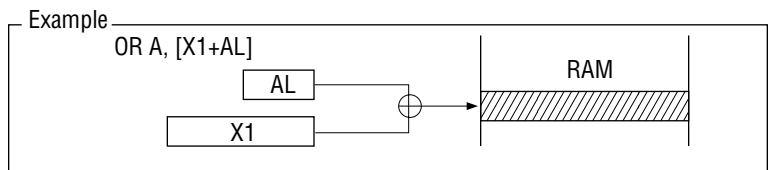

1.5 Special Bit Area Addressing

a) Fixed page SBA area (02C0H to 02FFH)

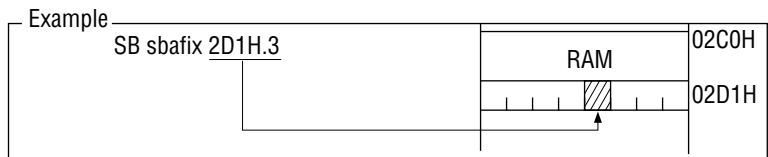

b) Current page SBA area (××C0H to ××FFH)

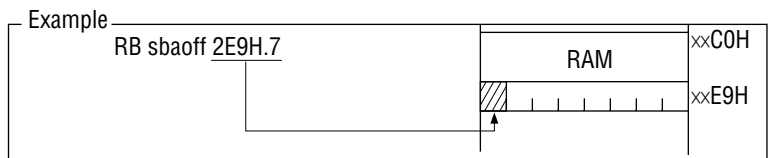

2. ROM Addressing Mode (for program space)

2.1 Immediate Addressing

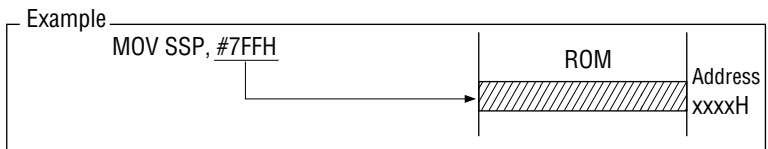

2.2 Table Data Addressing

a) Direct

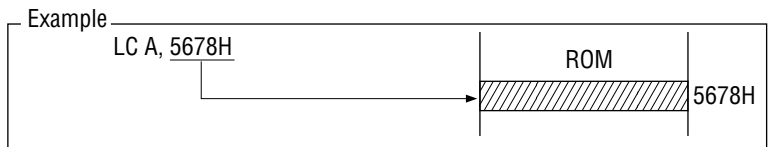

b) RAM addressing indirect

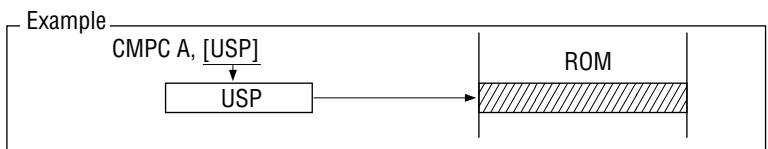

c) RAM addressing indirect with 16-bit base

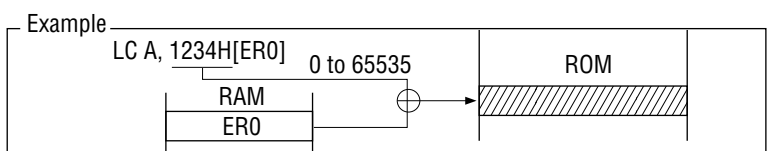

MEMORY MAPS

Program Memory Space

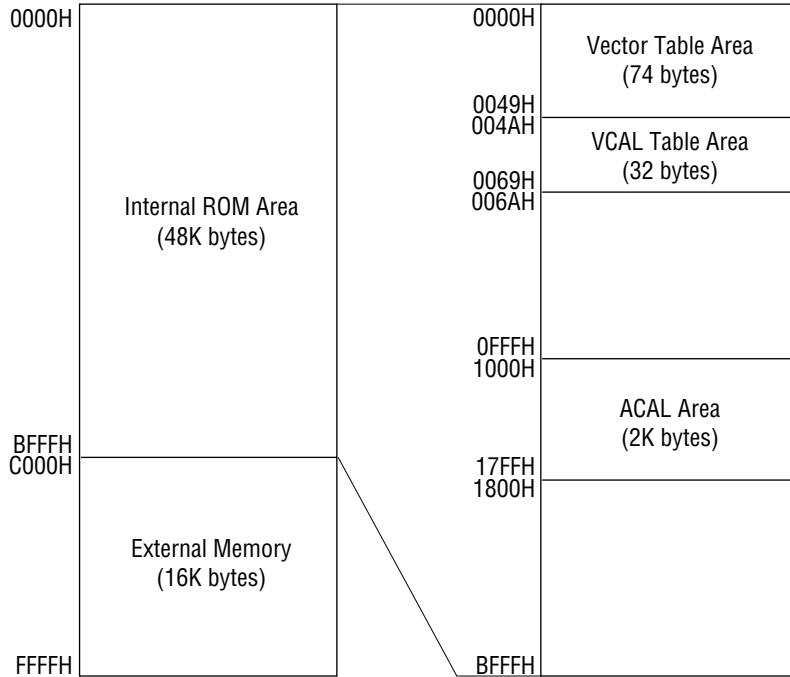

Data Memory Space

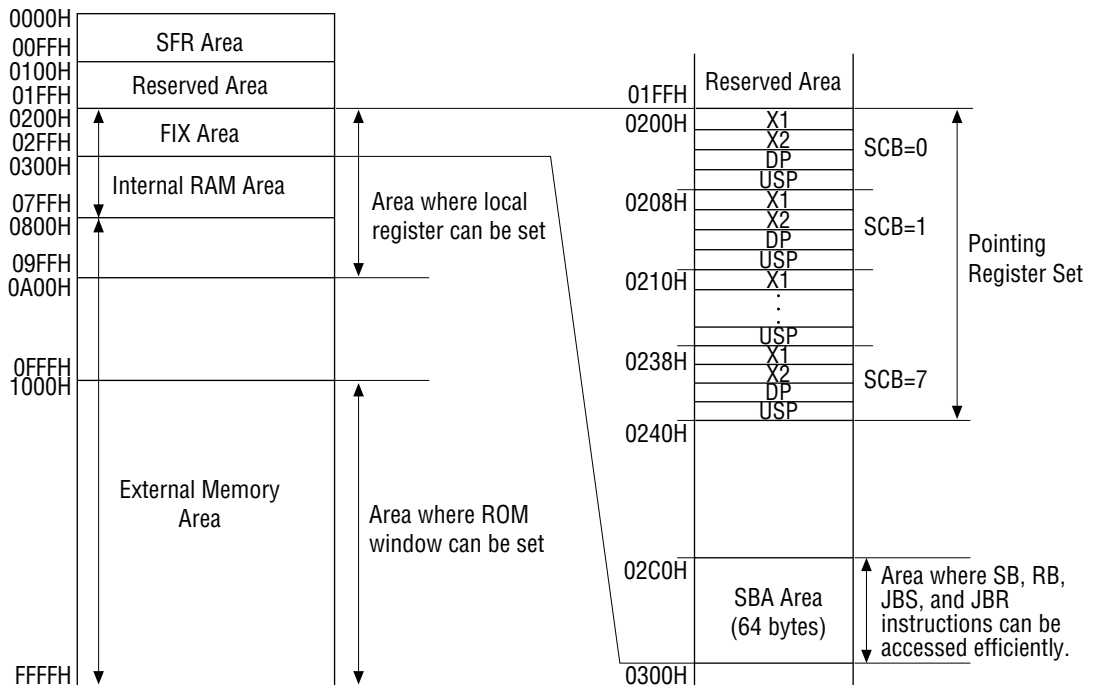

ABSOLUTE MAXIMUM RATINGS

(Ta=25°C)

Parameter	Symbol	Condition		Rating	Unit
Digital Power Supply Voltage	V _{DD}	GND=AGND=0V		-0.3 to +7.0	V
Input Voltage	V _I			-0.3 to V _{DD} +0.3	
Output Voltage	V _O			-0.3 to V _{DD} +0.3	
Analog Power Supply Voltage	AV _{DD}			-0.3 to V _{DD} +0.3	
Analog Reference Voltage	V _{REF}			-0.3 to AV _{DD} +0.3	
Analog Input Voltage	V _{AI}			-0.3 to V _{REF}	
Power Dissipation	P _D	Ta=85°C	Per package	1300	mW
			Per output	50	
Storage Temperature	T _{STG}	—		-50 to +150	°C

RECOMMENDED OPERATING CONDITIONS

Parameter	Symbol	Condition		Range	Unit
Digital Power Supply Voltage	V _{DD}	f _{OSC} ≤24MHz		4.5 to 5.5	V
Analog Power Supply Voltage	AV _{DD}	V _{DD} =AV _{DD}		4.5 to 5.5	
Analog Reference Voltage	V _{REF}	—		AV _{DD} -0.3 to AV _{DD}	
Analog Input Voltage	V _{AI}	—		AGND to V _{REF}	
Memory Hold Voltage	V _{DDH}	f _{OSC} =0Hz		2.0 to 5.5	
Operating Frequency	f _{OSC}	V _{DD} =5V±10%	Ta=-40 to +85°C	0 to 28	MHz
			Ta=-20 to +70°C	0 to 32	
Ambient Temperature	Ta	f _{OSC} ≤24MHz		-40 to +85	°C
Fan Out	N	MOS load		20	—
		TTL load	P0	2	—
			P1 to P7	1	—

ELECTRICAL CHARACTERISTICS

DC Characteristics

($V_{DD}=5V\pm 10\%$, $T_a=-40$ to $+85^\circ C$)

Parameter	Symbol	Condition	Min.	Typ	Max.	Unit	
H Level Input Voltage *1	V_{IH}	-	2.2	-	$V_{DD}+0.3$	V	
H Level Input Voltage *2, 5, 6			$0.80V_{DD}$	-	$V_{DD}+0.3$		
H Level Input Voltage *7			$0.85V_{DD}$	-	$V_{DD}+0.3$		
L Level Input Voltage *1	V_{IL}	-	-0.3	-	0.8		
L Level Input Voltage *2, 5, 6			-0.3	-	$0.2V_{DD}$		
L Level Input Voltage *7			-0.3	-	$0.15V_{DD}$		
H Level Output Voltage *1, 4	V_{OH}	$I_O=-400\mu A$	$V_{DD}-0.4$	-	-	mA	
H Level Output Voltage *2		$I_O=-200\mu A$	$V_{DD}-0.4$	-	-		
L Level Output Voltage *1, 4	V_{OL}	$I_O=3.2mA$	-	-	0.4		
L Level Output Voltage *2		$I_O=1.6mA$	-	-	0.4		
Input Leakage Current *3, 6	I_{IH}/I_{IL}	$V_I=V_{DD}/0V$	-	-	1/-1		μA
Input Current *5			-	-	1/-250		
Input Current *7			-	-	15/-15		
H Level Output Current *1, 4	I_{OH}	$V_O=2.4V$	-2	-	-	mA	
H Level Output Current *2			-1	-	-		
L Level Output Current *1, 4	I_{OL}		10	-	-		
L Level Output Current *2			5	-	-		
Output Leakage Current *1, 2, 4	I_{LO}	$V_O=V_{DD}/0V$	-	-	± 2	μA	
Input Capacitance	C_I	$f=1MHz, T_a=25^\circ C$	-	5	-	pF	
Output Capacitance	C_O		-	7	-		
Analog Reference Power Supply Voltage	I_{REF}	A/D in operation	-	-	4	mA	
		A/D stopped	-	-	10	μA	
Power Consumption (in STOP mode)	I_{DDs}	$V_{DD}=2V, T_a=25^\circ C$ *8	-	0.2	10	μA	
			*8	-	1		100
Power Consumption (in HALT mode)	I_{DDH}	$f_{osc}=24MHz$ No load	-	25	60	mA	
			I_{DD}	-	55		130

*1. Applied to P0

*2. Applied to P1-P7

*3. Applied to A_{in}

*4. Applied to ALE, \overline{PSEN}

*5. Applied to \overline{RES}

*6. Applied to \overline{EA} , \overline{OE} , NMI

*7. Applied to OSC0

*8. Ports for input pins are V_{DD} or GND, otherwise no load.

AC Characteristics

• **External program memory control**

($V_{DD}=5V\pm 10\%$, $T_a=-40$ to $+85^\circ C$)

Parameter	Symbol	Condition	Min.	Max.	Unit
Clock Pulse Width (OSC)	$t_{\theta W}$	–	20.833	–	ns
ALE Pulse Width	t_{AW}	$C_L=50PF$	$3t_{\theta W}-10$	–	
\overline{PSEN} Pulse Width	t_{PW}		$4t_{\theta W}-10$	–	
\overline{PSEN} Pulse Delay Time	t_{PAD}		$t_{\theta W}-5$	$t_{\theta W}+5$	
Low Address Setup Time	t_{AAS}		$2t_{\theta W}-10$	$2t_{\theta W}+10$	
Low Address Hold Time	t_{AAH}		$t_{\theta W}-5$	$t_{\theta W}+5$	
High Address Delay Time	t_{AAD}		$t_{\theta W}-0$	$t_{\theta W}+10$	
High Address Hold Time	t_{APH}		$t_{\theta W}-0$	$t_{\theta W}+10$	
Instruction Setup Time	t_{IS}		35	–	
Instruction Hold Time	t_{IH}		0	$t_{\theta W}-10$	

• **External data memory control**

($V_{DD}=5V\pm 10\%$, $T_a=-40$ to $+85^\circ C$)

Parameter	Symbol	Condition	Min.	Max.	Unit
Clock Pulse Width (OSC)	$t_{\theta W}$	–	20.833	–	ns
ALE Pulse Width	t_{AW}	$C_L=50PF$	$3t_{\theta W}-10$	–	
\overline{RD} Pulse Width	t_{RW}		$4t_{\theta W}-10$	–	
\overline{WR} Pulse Width	t_{WW}		$4t_{\theta W}-10$	–	
\overline{RD} Pulse Delay Time	t_{RAD}		$t_{\theta W}-5$	$t_{\theta W}+5$	
\overline{WR} Pulse Delay Time	t_{WAD}		$t_{\theta W}-5$	$t_{\theta W}+5$	
Low Address Setup Time	t_{AAS}		$2t_{\theta W}-10$	$2t_{\theta W}+10$	
Low Address Hold Time	t_{AAH}		$t_{\theta W}-5$	$t_{\theta W}+5$	
High Address Setup Time	t_{AAD}		$t_{\theta W}-0$	$t_{\theta W}+10$	
High Address Hold Time	t_{ARH}		$t_{\theta W}-0$	$t_{\theta W}+10$	
High Address Hold Time	t_{AWH}		$t_{\theta W}-0$	$t_{\theta W}+10$	
Memory Data Setup Time	t_{MS}		35	–	
Memory Data Hold Time	t_{MH}		0	$t_{\theta W}-10$	
Data Setup Time	t_{DD}		$t_{\theta W}-0$	$t_{\theta W}+10$	
Data Hold Time	t_{DH}		$t_{\theta W}-0$	$t_{\theta W}+10$	

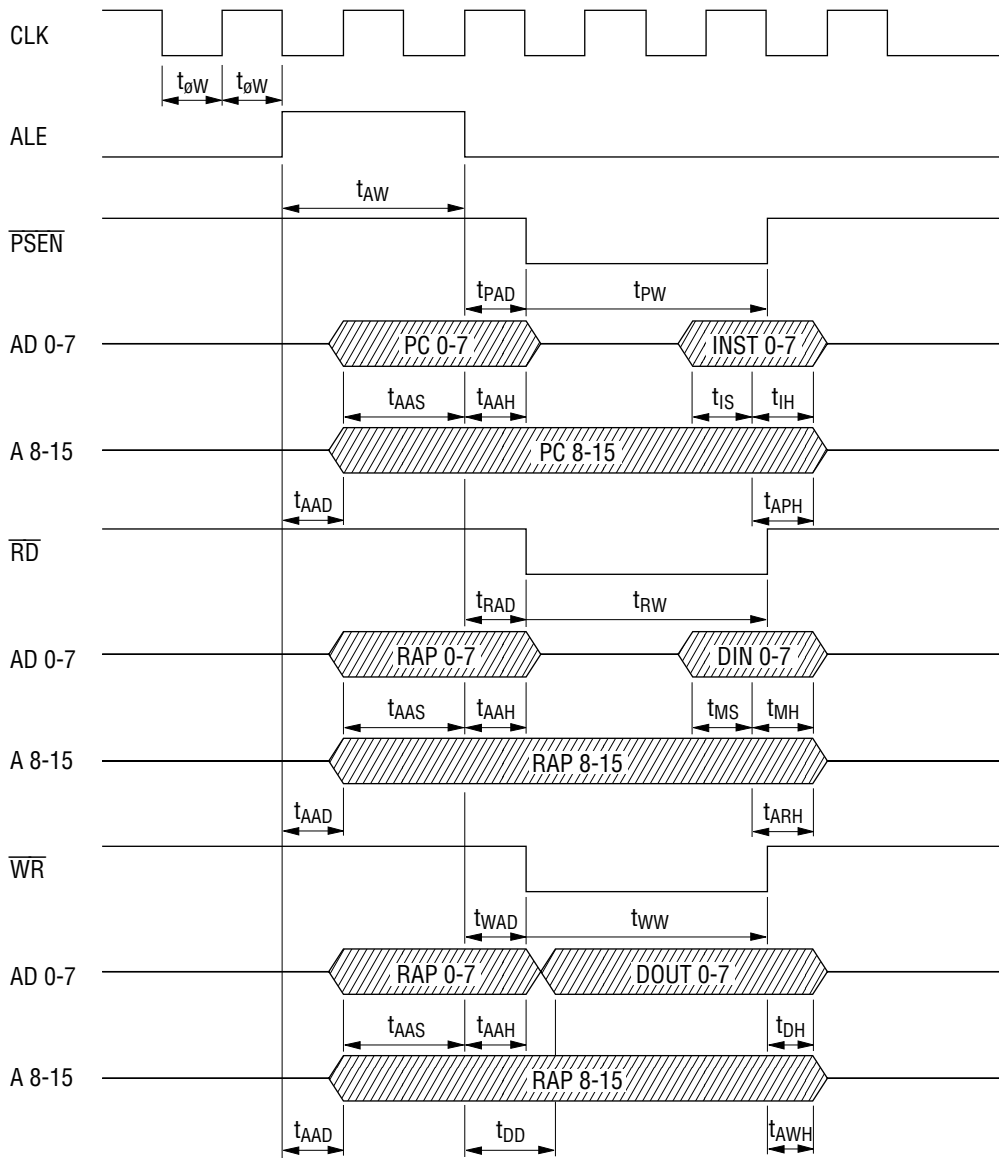

A/D Converter Characteristics

($AV_{DD}=V_{DD}=V_{REF}=5V \pm 10\%$, $AGND=GND=0V$, $T_a=-40$ to $+85^\circ C$)

Parameter	Symbol	Condition	Min.	Typ.	Max.	Unit
Resolution	n	Refer to the recommended circuit (Figure1). Analog input source impedance $R_I \leq 5k\Omega$ $t_{CONV}=512\phi/CH$	-	-	10	Bit
Linearity Error	E_L		-	-	± 3	
Differential Linearity Error	E_D		-	-	± 1	
Zero Scale Error	E_{ZS}		0	-	+3	
Full Scale Error	E_{FS}		-	-	-3	
Crosstalk	E_{CT}	Refer to the measuring circuit (Figure 2).	-	-	± 1	LSB
Conversion Time	t_{CONV}	by ADTM set data $\phi=1/f_{OSC}$	256 ϕ	-	768 ϕ	$\mu s/CH$

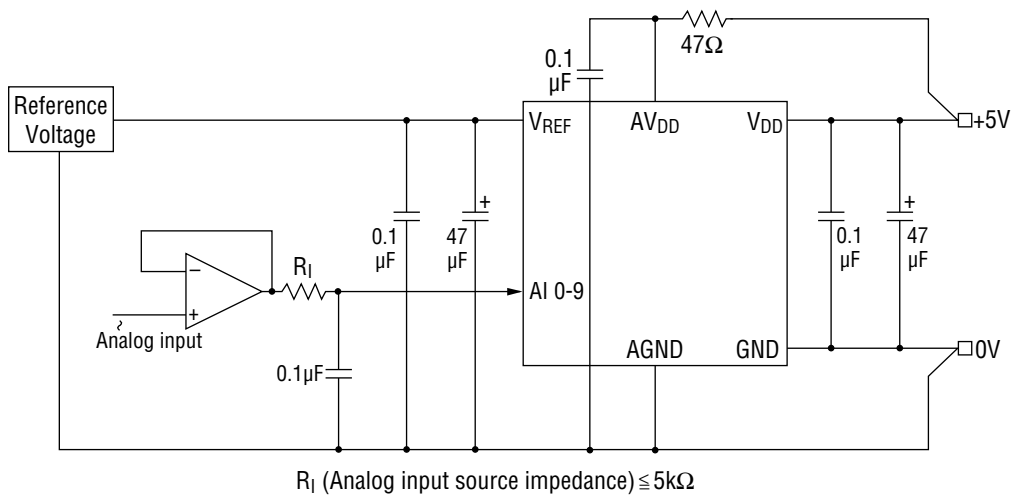

Figure 1 Recommended Circuit

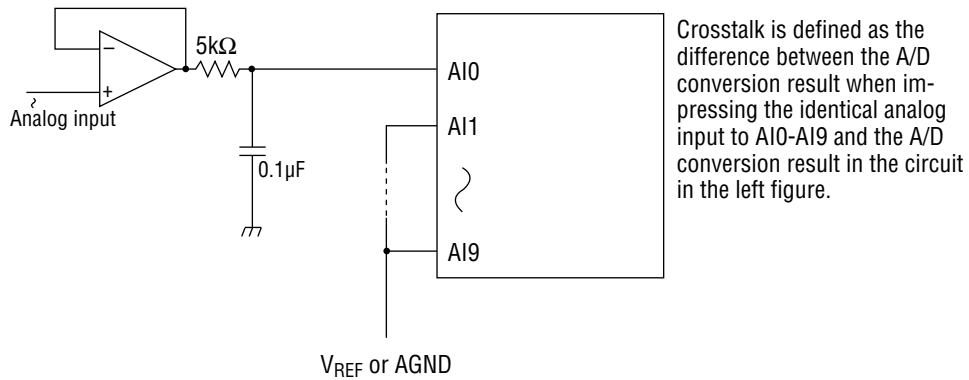

Figure 2 Crosstalk Measuring Circuit

Definitions of Terms

1. Resolution

The minimum distinguishable analog input value. For 10 bits, $2^{10}=1024$, i.e. $(V_{REF}-AGND) \div 1024$

2. Linearity Error

The variance between the ideal conversion characteristics as a 10-bit A/D converter and the actual conversion characteristics. (Quantized error is therefore not included.)

3. Differential Linearity Error

The smoothness of the conversion. The width of analog input voltage corresponding to the change by one bit of digital output is $1 \text{ LSB}=(V_{REF}-AGND) \div 1024$ ideally. The variance between this ideal bit size and bit size at arbitrary point in the conversion range.

4. Zero Scale Error

The variance between the ideal conversion characteristics at the switching point of digital output "000H to 001H" and actual conversion characteristics.

5. Full Scale Error

The variance between the ideal conversion characteristics at the switching point of digital output "3FEH to 3FFH" and actual conversion characteristics.

PACKAGE DIMENSIONS

(Unit : mm)

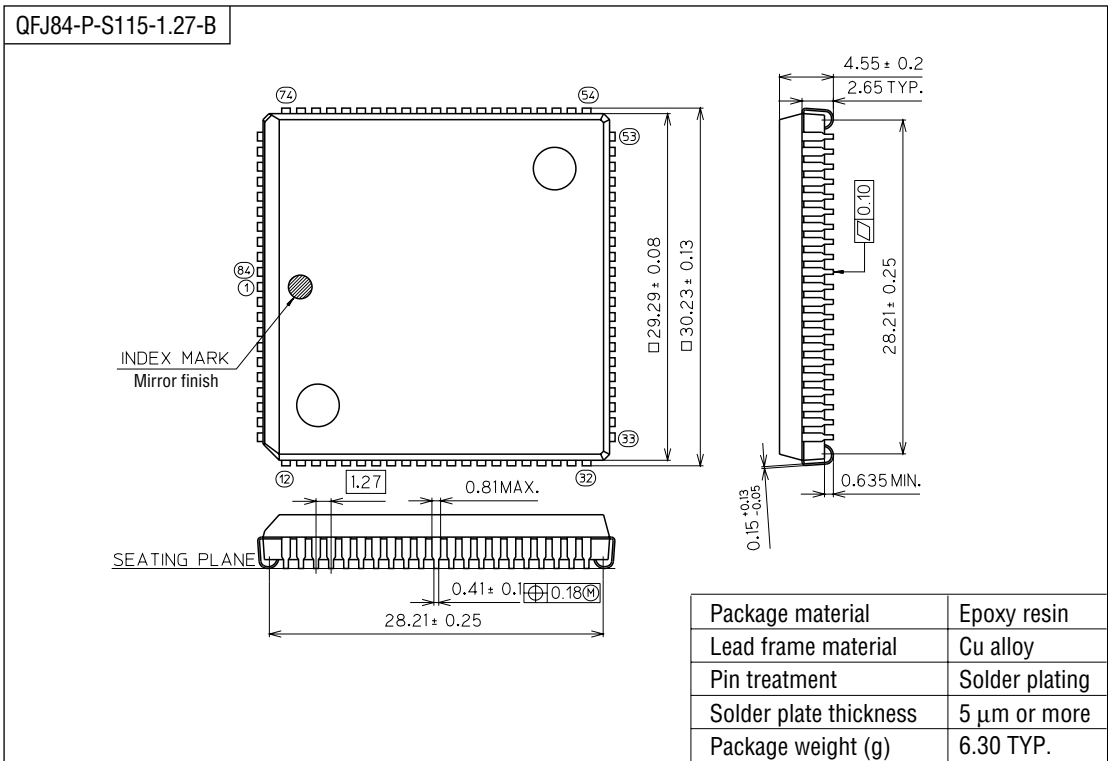

Notes for Mounting the Surface Mount Type Package

The SOP, QFP, TSOP, SOJ, QFJ (PLCC), SHP and BGA are surface mount type packages, which are very susceptible to heat in reflow mounting and humidity absorbed in storage. Therefore, before you perform reflow mounting, contact Oki's responsible sales person for the product name, package name, pin number, package code and desired mounting conditions (reflow method, temperature and times).