

Diagonal 6mm (Type 1/3) Progressive Scan CCD Image Sensor with Square Pixel for B/W Cameras

Description

The ICX204AL is a diagonal 6mm (Type 1/3) interline CCD solid-state image sensor with a square pixel array and 800K effective pixels. Progressive scan allows all pixels' signals to be output independently. Also, the adoption of high frame rate readout mode supports 60 frames per second. This chip features an electronic shutter with variable charge-storage time which makes it possible to realize full-frame still image without a mechanical shutter. Further, high sensitivity and low dark current are achieved through the adoption of HAD (Hole-Accumulation Diode) sensors.

This chip is suitable for applications such as FA cameras, two-dimensional bar-code reader, etc.

Features

- Progressive scan allows individual readout of the image signals from all pixels.
- High horizontal and vertical resolution (both approx. 768TV-lines) still image without a mechanical shutter.
- Supports high frame rate readout mode (effective 256 lines output, 15MHz drive: 45 frame/s, 20MHz drive: 60 frame/s)
- Square pixel
- Horizontal drive frequency: Typ.: 15MHz, Max.: 20MHz
- No voltage adjustments (reset gate and substrate bias are not adjusted.)
- High resolution, high sensitivity, low dark current
- Low smear, excellent antiblooming characteristics
- Continuous variable-speed shutter
- Recommended range of exit pupil distance: -20 to -100mm

Device Structure

- Interline CCD image sensor
- Image size: Diagonal 6mm (Type 1/3)
- Total number of pixels: 1077 (H) × 788 (V) approx. 850K pixels
- Number of effective pixels: 1034 (H) × 779 (V) approx. 800K pixels
- Number of active pixels: 1024 (H) × 768 (V) approx. 790K pixels (diagonal 5.952mm)
- Chip size: 5.80mm (H) × 4.92mm (V)
- Unit cell size: 4.65µm (H) × 4.65µm (V)
- Optical black: Horizontal (H) direction: Front 3 pixels, rear 40 pixels
Vertical (V) direction: Front 7 pixels, rear 2 pixels
- Number of dummy bits: Horizontal 29
Vertical 1
- Substrate material: Silicon

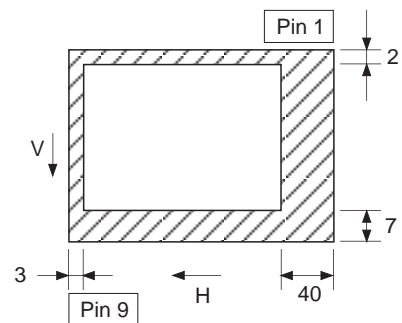
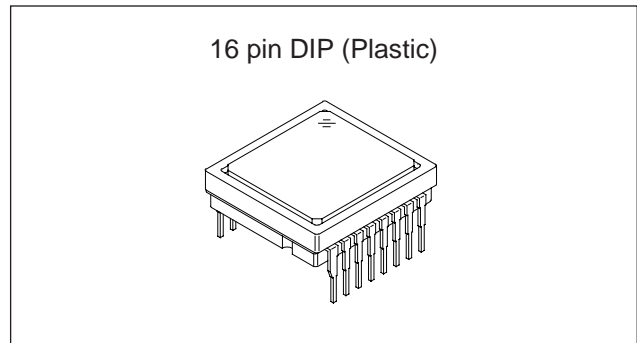

Optical black position (Top View)

Sony reserves the right to change products and specifications without prior notice. This information does not convey any license by any implication or otherwise under any patents or other right. Application circuits shown, if any, are typical examples illustrating the operation of the devices. Sony cannot assume responsibility for any problems arising out of the use of these circuits.

Block Diagram and Pin Configuration

(Top View)

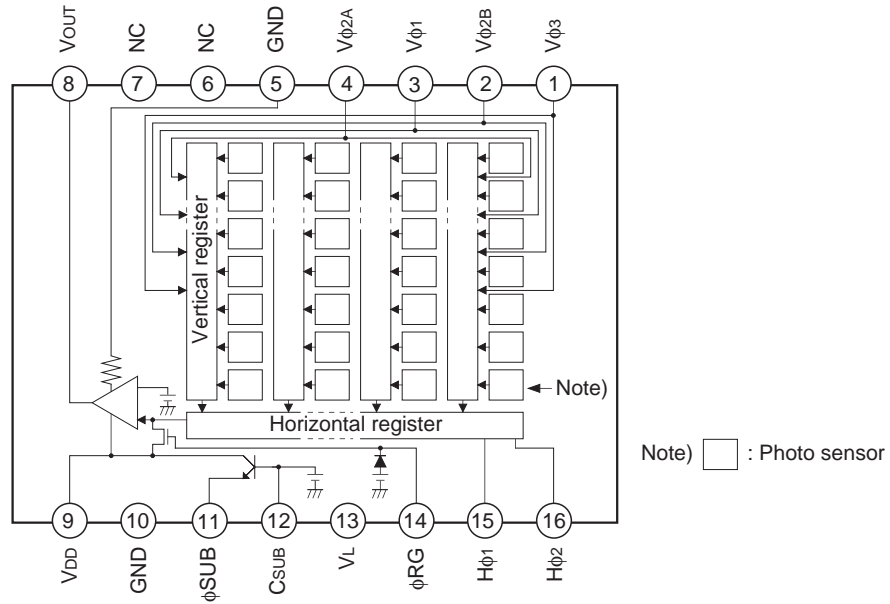

Pin Description

Pin No.	Symbol	Description	Pin No.	Symbol	Description
1	$V\phi_3$	Vertical register transfer clock	9	V_{DD}	Supply voltage
2	$V\phi_{2B}$	Vertical register transfer clock	10	GND	GND
3	$V\phi_1$	Vertical register transfer clock	11	ϕ_{SUB}	Substrate clock
4	$V\phi_{2A}$	Vertical register transfer clock	12	C_{SUB}	Substrate bias*1
5	GND	GND	13	V_L	Protective transistor bias
6	NC		14	ϕ_{RG}	Reset gate clock
7	NC		15	$H\phi_1$	Horizontal register transfer clock
8	V_{OUT}	Signal output	16	$H\phi_2$	Horizontal register transfer clock

*1 DC bias is generated within the CCD, so that this pin should be grounded externally through a capacitance of 0.1 μ F.

Absolute Maximum Ratings

Item		Ratings	Unit	Remarks
Against ϕ SUB	V_{DD} , V_{OUT} , ϕ RG – ϕ SUB	–40 to +10	V	
	$V\phi_{2A}$, $V\phi_{2B}$ – ϕ SUB	–50 to +15	V	
	$V\phi_1$, $V\phi_3$, V_L – ϕ SUB	–50 to +0.3	V	
	$H\phi_1$, $H\phi_2$, GND – ϕ SUB	–40 to +0.3	V	
	C_{SUB} – ϕ SUB	–25 to	V	
Against GND	V_{DD} , V_{OUT} , ϕ RG, C_{SUB} – GND	–0.3 to +18	V	
	$V\phi_1$, $V\phi_{2A}$, $V\phi_{2B}$, $V\phi_3$ – GND	–10 to +18	V	
	$H\phi_1$, $H\phi_2$ – GND	–10 to +5	V	
Against V_L	$V\phi_{2A}$, $V\phi_{2B}$ – V_L	–0.3 to +28	V	
	$V\phi_1$, $V\phi_3$, $H\phi_1$, $H\phi_2$, GND – V_L	–0.3 to +15	V	
Between input clock pins	Voltage difference between vertical clock input pins	to +15	V	*2
	$H\phi_1$ – $H\phi_2$	–5 to +5	V	
	$H\phi_1$, $H\phi_2$ – $V\phi_3$	–13 to +13	V	
Storage temperature		–30 to +80	°C	
Operating temperature		–10 to +60	°C	

*2 +24V (Max.) when clock width < 10 μ s, clock duty factor < 0.1%.

+16V (Max.) is guaranteed for turning on or off power supply.

Bias Conditions

Item	Symbol	Min.	Typ.	Max.	Unit	Remarks
Supply voltage	V _{DD}	14.55	15.0	15.45	V	
Protective transistor bias	V _L	*1				
Substrate clock	φ _{SUB}	*2				
Reset gate clock	φ _{RG}	*2				

*1 V_L setting is the V_L voltage of the vertical transfer clock waveform, or the same power supply as the V_L power supply for the V driver should be used.

*2 Do not apply a DC bias to the substrate clock and reset gate clock pins, because a DC bias is generated within the CCD.

DC Characteristics

Item	Symbol	Min.	Typ.	Max.	Unit	Remarks
Supply current	I _{DD}		5.5		mA	

Clock Voltage Conditions

Item	Symbol	Min.	Typ.	Max.	Unit	Waveform diagram	Remarks
Readout clock voltage	V _{VT}	14.55	15.0	15.45	V	1	
Vertical transfer clock voltage	V _{VH02A}	-0.05	0	0.05	V	2	V _{VH} = V _{VH02A}
	V _{VH1} , V _{VH2A} , V _{VH2B} , V _{VH3}	-0.2	0	0.05	V	2	
	V _{VL1} , V _{VL2A} , V _{VL2B} , V _{VL3}	-8	-7.5	-7	V	2	V _{VL} = (V _{VL1} + V _{VL3})/2
	V _{φ1} , V _{φ2A} , V _{φ2B} , V _{φ3}	7	7.5	8	V	2	
	V _{VL1} - V _{VL3}			0.1	V	2	
	V _{VHH}			0.9	V	2	High-level coupling
	V _{VHL}			1.3	V	2	High-level coupling
	V _{VLH}			1.0	V	2	Low-level coupling
	V _{VLL}			0.9	V	2	Low-level coupling
Horizontal transfer clock voltage	V _{φH}	3.0	3.3	3.6	V	3	
	V _{HL}	-0.05	0	0.05	V	3	
Reset gate clock voltage	V _{φRG}	3.0	3.3	3.6	V	4	
	V _{RGLH} - V _{RGLL}			0.4	V	4	Low-level coupling
	V _{RGL} - V _{RGLm}			0.5	V	4	Low-level coupling
Substrate clock voltage	V _{φSUB}	21.55	22.5	23.45	V	5	

Clock Equivalent Circuit Constant

Item	Symbol	Min.	Typ.	Max.	Unit	Remarks
Capacitance between vertical transfer clock and GND	$C_{\phi V1}$		1500		pF	
	$C_{\phi V2A}$		1800		pF	
	$C_{\phi V2B}$		2700		pF	
	$C_{\phi V3}$		2200		pF	
Capacitance between vertical transfer clocks	$C_{\phi V12A}$		390		pF	
	$C_{\phi V2B1}$		680		pF	
	$C_{\phi V2A3}$		560		pF	
	$C_{\phi V32B}$		1000		pF	
	$C_{\phi V13}$		1800		pF	
	$C_{\phi V2A2B}$		33		pF	
Capacitance between horizontal transfer clock and GND	$C_{\phi H1}, C_{\phi H2}$		18		pF	
Capacitance between horizontal transfer clocks	$C_{\phi HH}$		43		pF	
Capacitance between reset gate clock and GND	$C_{\phi RG}$		3		pF	
Capacitance between substrate clock and GND	$C_{\phi SUB}$		390		pF	
Vertical transfer clock series resistor	R_1		91		Ω	
	R_{2A}		68		Ω	
	R_{2B}		62		Ω	
	R_3		30		Ω	
Vertical transfer clock ground resistor	R_{GND}		43		Ω	
Horizontal transfer clock series resistor	$R_{\phi H}$		10		Ω	

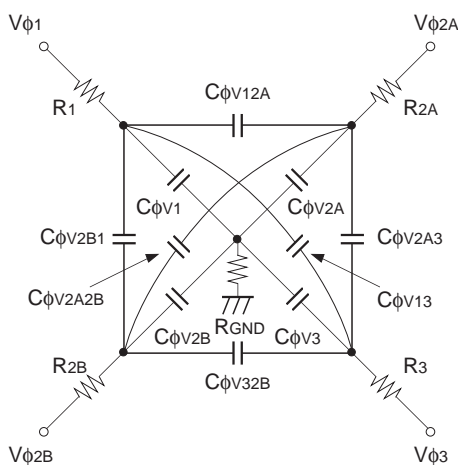

Vertical transfer clock equivalent circuit

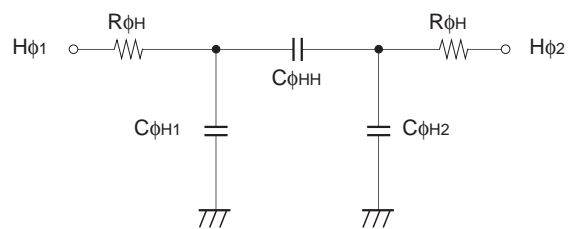

Horizontal transfer clock equivalent circuit

Drive Clock Waveform Conditions

(1) Readout clock waveform

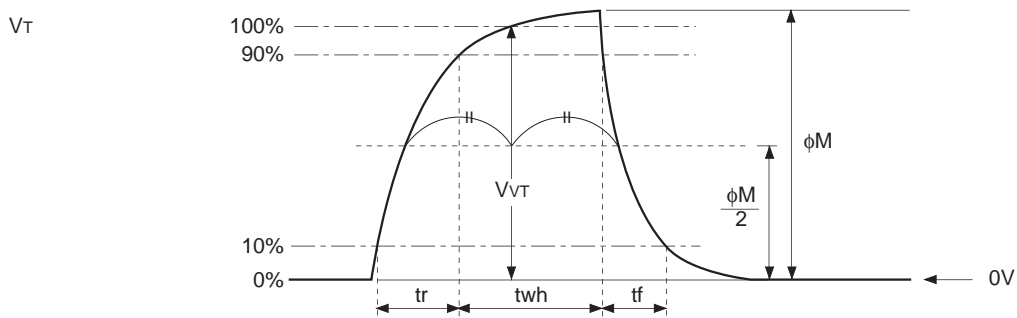

Note) Readout clock is used by composing vertical transfer clocks \$V\phi_{2A}\$ and \$V\phi_{2B}\$.

(2) Vertical transfer clock waveform

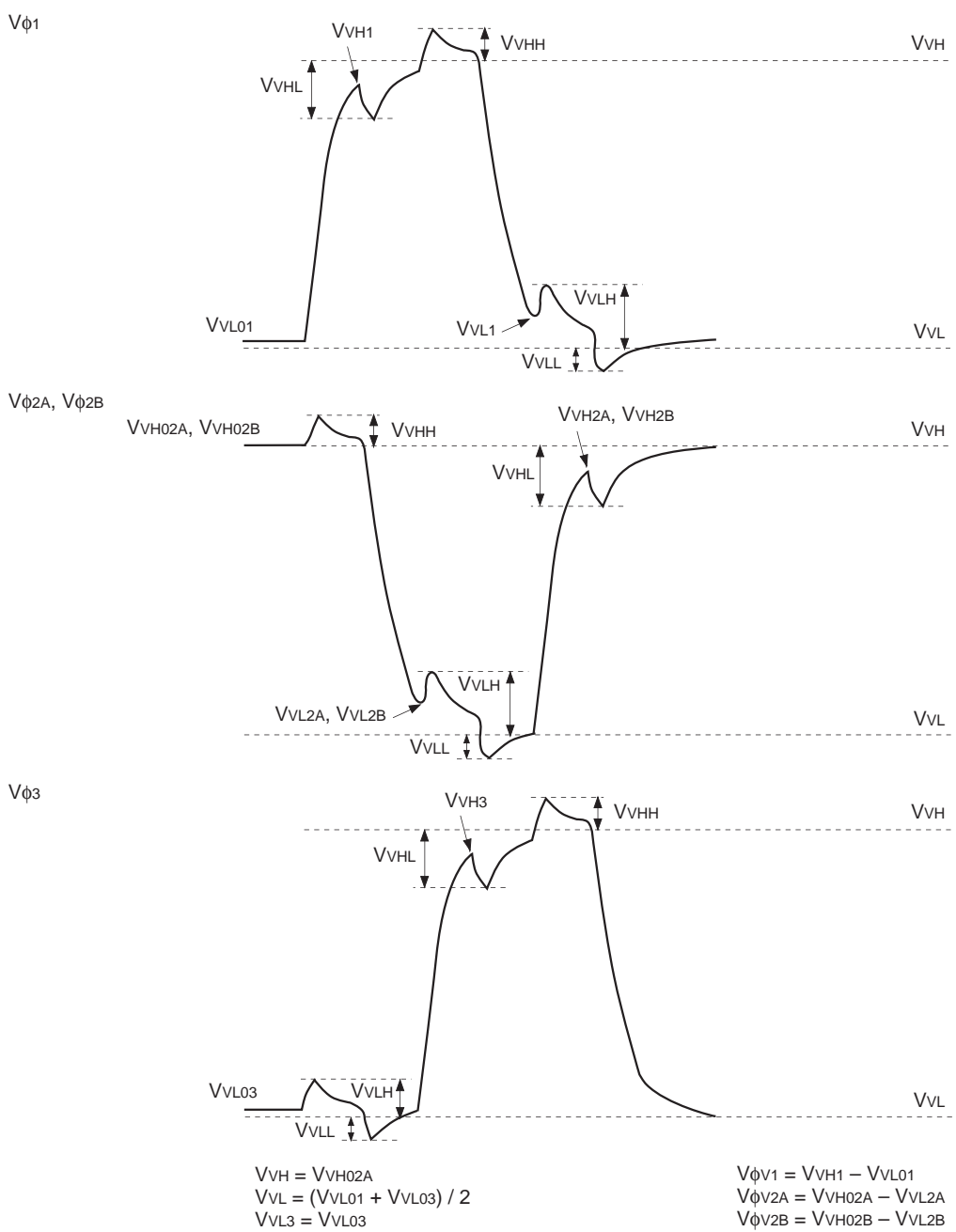

(3) Horizontal transfer clock waveform

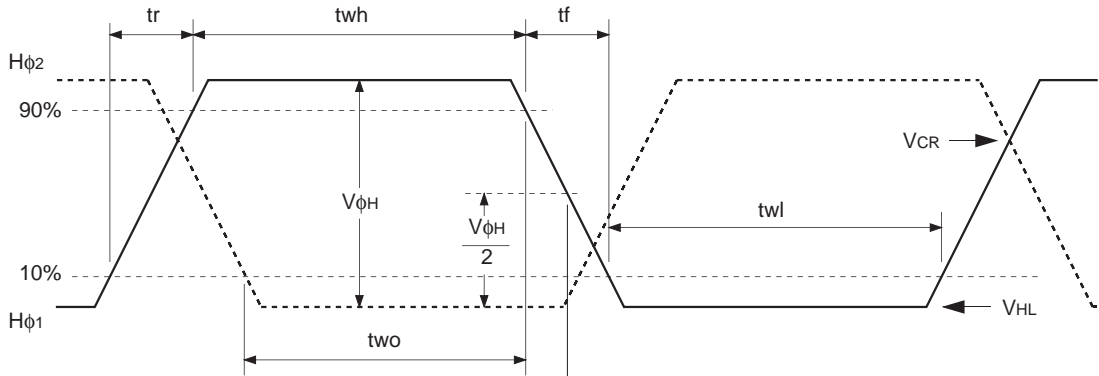

Cross-point voltage for the $H\phi_1$ rising side of the horizontal transfer clocks $H\phi_1$ and $H\phi_2$ waveforms is V_{CR} . The overlap period for t_{wh} and t_{wl} of horizontal transfer clocks $H\phi_1$ and $H\phi_2$ is two.

(4) Reset gate clock waveform

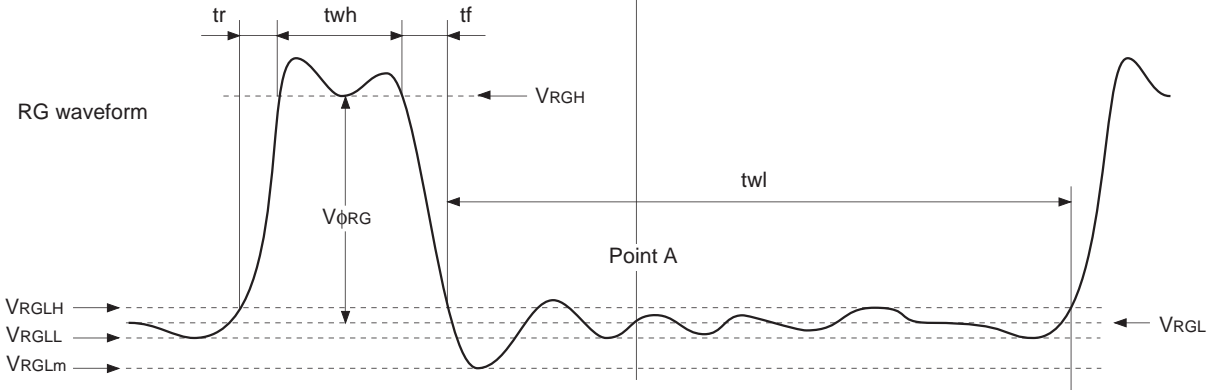

V_{RGLH} is the maximum value and V_{RGLL} is the minimum value of the coupling waveform during the period from Point A in the above diagram until the rising edge of RG.

In addition, V_{RGL} is the average value of V_{RGLH} and V_{RGLL} .

$$V_{RGL} = (V_{RGLH} + V_{RGLL})/2$$

Assuming V_{RGH} is the minimum value during the interval t_{wh} , then:

$$V_{\phi RG} = V_{RGH} - V_{RGL}$$

Negative overshoot level during the falling edge of RG is V_{RGLm} .

(5) Substrate clock waveform

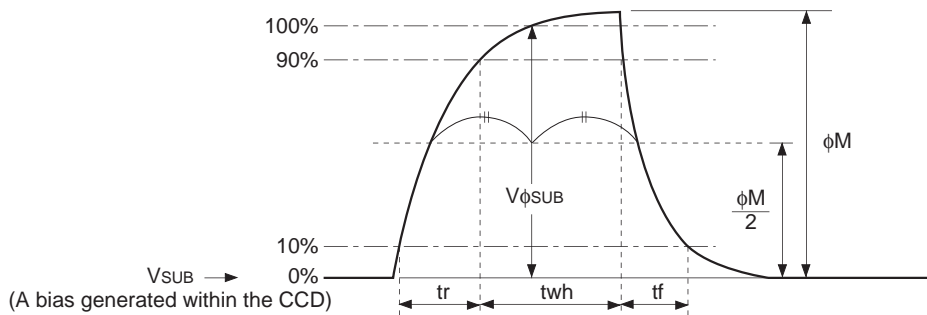

Clock Switching Characteristics

Item	Symbol	twh			twl			tr			tf			Unit	Remarks
		Min.	Typ.	Max.	Min.	Typ.	Max.	Min.	Typ.	Max.	Min.	Typ.	Max.		
Readout clock	V _T	2.3	2.5						0.5			0.5		μs	During readout
Vertical transfer clock	V _{φ1} , V _{φ2A} , V _{φ2B} , V _{φ3}										15		350	ns	*1
Horizontal transfer clock	During imaging	H _{φ1}	12.5	17		12.5	17		8	12.5		8	12.5	ns	*2
		H _{φ2}	12.5	17		12.5	17		8	12.5		8	12.5		
	During parallel-serial conversion	H _{φ1}					8.2		0.01			0.01		μs	
		H _{φ2}		8.2					0.01			0.01			
Reset gate clock	φ _{RG}	7	10			34		3			3		ns		
Substrate clock	φ _{SUB}		2.2								0.5		0.5	μs	During drain charge

*1 When vertical transfer clock driver CXD1267AN is used.

*2 $tf \geq tr - 2ns$, and the cross-point voltage (V_{CR}) for the H_{φ1} rising side of the H_{φ1} and H_{φ2} waveforms must be at least V_{φH/2} [V].

Item	Symbol	two			Unit	Remarks
		Min.	Typ.	Max.		
Horizontal transfer clock	H _{φ1} , H _{φ2}	10.5	17		ns	

Spectral Sensitivity Characteristics (excludes lens characteristics and light source characteristics)

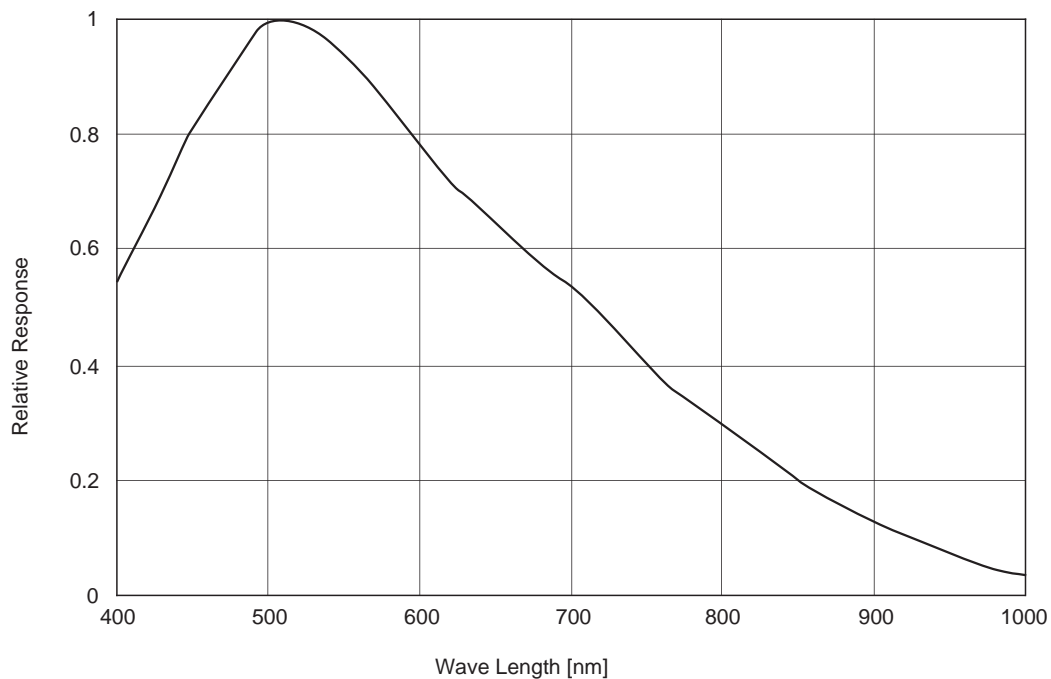
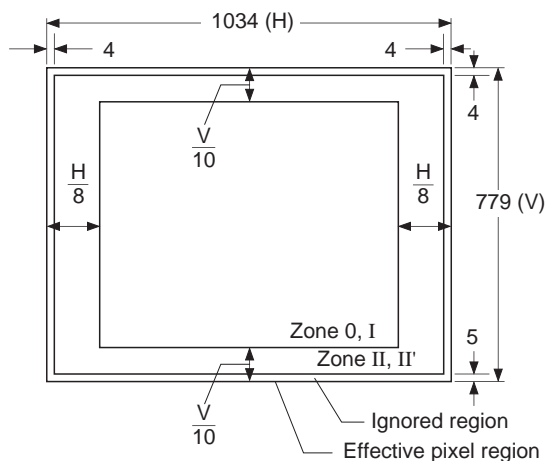

Image Sensor Characteristics

(Ta = 25°C)

Item	Symbol	Min.	Typ.	Max.	Unit	Measurement method	Remarks
Sensitivity	S	360	450		mV	1	1/30s accumulation
Saturation signal	Vsat	450			mV	2	Ta = 60°C
Smear	Sm		0.001	0.004	%	3	No electronic shutter
Video signal shading	SH			20	%	4	Zone 0 and I
				25	%	4	Zone 0 to II'
Dark signal	Vdt			6	mV	5	Ta = 60°C, 20 frame/s
Dark signal shading	ΔVdt			2	mV	6	Ta = 60°C, 20 frame/s
Lag	Lag			0.5	%	7	

Zone Definition of Video Signal Shading



Measurement System

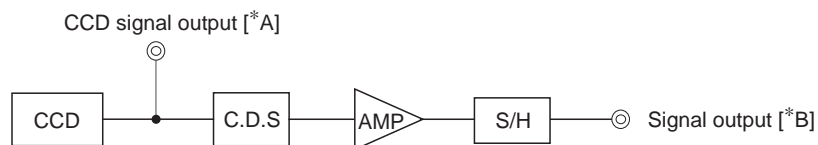

Note) Adjust the amplifier gain so that the gain between [*A] and [*B] equals 1.

Image Sensor Characteristics Measurement Method

◎ **Readout modes**

The diagram below shows the output methods for the following two readout modes.

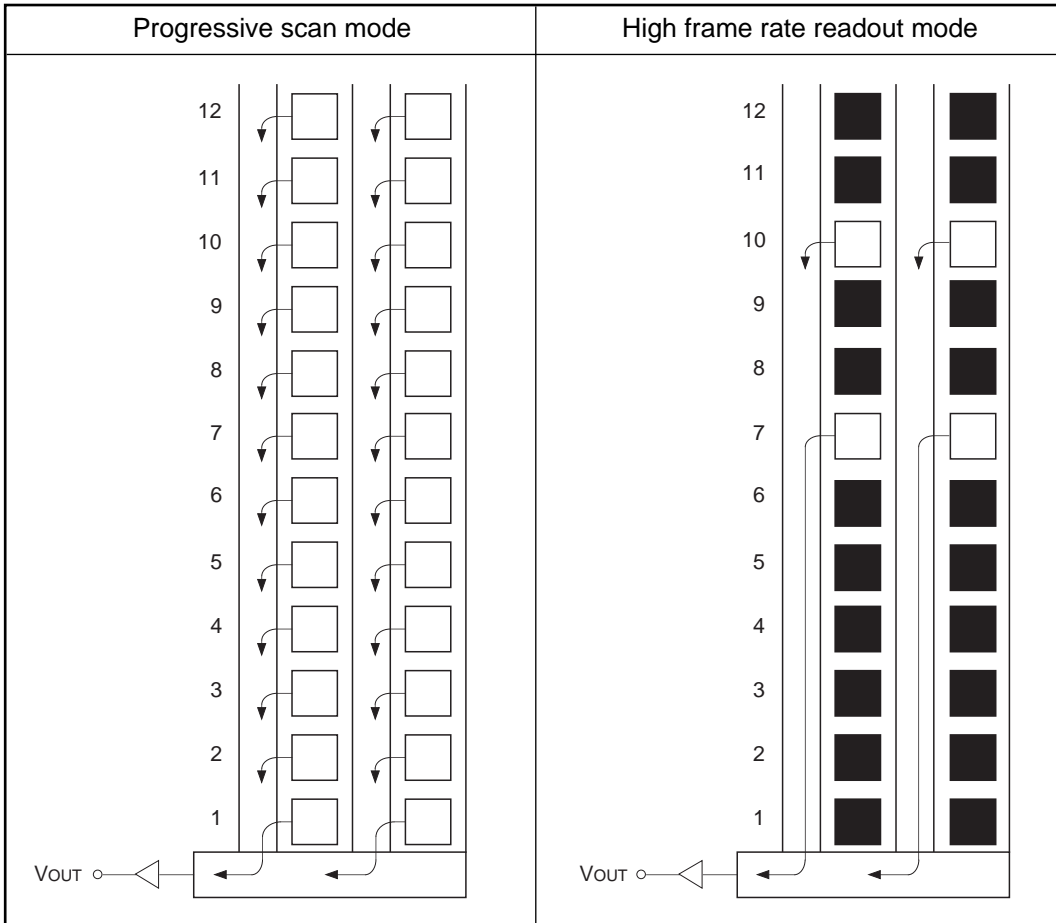

Note) Blacked out portions in the diagram indicate pixels which are not read out.
Output starts from the line 7 in high frame rate readout mode.

1. Progressive scan mode

In this mode, all pixel signals are output in non-interlace format in 1/20s.

The vertical resolution is approximately 768TV-lines and all pixel signals within the same exposure period are read out simultaneously, making this mode suitable for high resolution image capturing.

2. High frame rate readout mode

All effective areas are scanned in approximately 1/60s by reading out one line for every three lines. The vertical resolution is approximately 256TV-lines.

This readout mode emphasizes processing speed over vertical resolution.

◎ Measurement conditions

- 1) In the following measurements, the device drive conditions are at the typical values of the progressive scan mode, bias and clock voltage conditions.
- 2) In the following measurements, spot blemishes are excluded and, unless otherwise specified, the optical black level (OB) is used as the reference for the signal output, which is taken as the value measured at point [*B] of the measurement system.

◎ Definition of standard imaging conditions

- 1) Standard imaging condition I:
Use a pattern box (luminance: 706cd/m², color temperature of 3200K halogen source) as a subject. (Pattern for evaluation is not applicable.) Use a testing standard lens with CM500S (t = 1.0mm) as an IR cut filter and image at F8. The luminous intensity to the sensor receiving surface at this point is defined as the standard sensitivity testing luminous intensity.
- 2) Standard imaging condition II:
Image a light source (color temperature of 3200K) with a uniformity of brightness within 2% at all angles. Use a testing standard lens with CM500S (t = 1.0mm) as an IR cut filter. The luminous intensity is adjusted to the value indicated in each testing item by the lens diaphragm.
- 3) Standard imaging condition III:
Image a light source (color temperature of 3200K) with a uniformity of brightness within 2% at all angles. Use a testing standard lens (exit pupil distance –33mm) with CM500S (t = 1.0mm) as an IR cut filter. The luminous intensity is adjusted to the value indicated in each testing item by the lens diaphragm.

1. Sensitivity

Set to standard imaging condition I. After selecting the electronic shutter mode with a shutter speed of 1/250s, measure the signal outputs (Vs) at the center of screen, and substitute the values into the following formulas.

$$S = V_s \times \frac{250}{30} \text{ [mV]}$$

2. Saturation signal

Set to standard imaging condition II. After adjusting the luminous intensity to 10 times the intensity with the average value of the signal output, 150mV, measure the minimum values of the signal output.

3. Smear

Set to standard imaging condition II. With the lens diaphragm at F5.6 to F8, first adjust the luminous intensity to 500 times the intensity with the average value of the signal output, 150mV. Then after the readout clock is stopped and the charge drain is executed by the electronic shutter at the respective H blankings, measure the maximum value (Vsm [mV]) of the signal output, and substitute the values into the following formula.

$$S_m = \frac{V_{sm}}{150} \times \frac{1}{500} \times \frac{1}{10} \times 100 \text{ [%]} \text{ (1/10V method conversion value)}$$

4. Video signal shading

Set to standard imaging condition III. With the lens diaphragm at F5.6 to F8, adjust the luminous intensity so that the average value of the signal output is 150mV. Then measure the maximum (Vmax [mV]) and minimum (Vmin [mV]) values of the signal output and substitute the values into the following formula.

$$SH = (V_{max} - V_{min}) / 150 \times 100 [\%]$$

5. Dark signal

Measure the average value of the signal output (Vdt [mV]) with the device ambient temperature 60°C and the device in the light-obstructed state, using the horizontal idle transfer level as a reference.

6. Dark signal shading

After measuring 5, measure the maximum (Vdmax [mV]) and minimum (Vdmin [mV]) values of the dark signal output and substitute the values into the following formula.

$$\Delta V_{dt} = V_{dmax} - V_{dmin} [mV]$$

7. Lag

Adjust the signal output value generated by strobe light to 150mV. After setting the strobe light so that it strobes with the following timing, measure the residual signal (Vlag). Substitute the value into the following formula.

$$Lag = (V_{lag} / 150) \times 100 [\%]$$

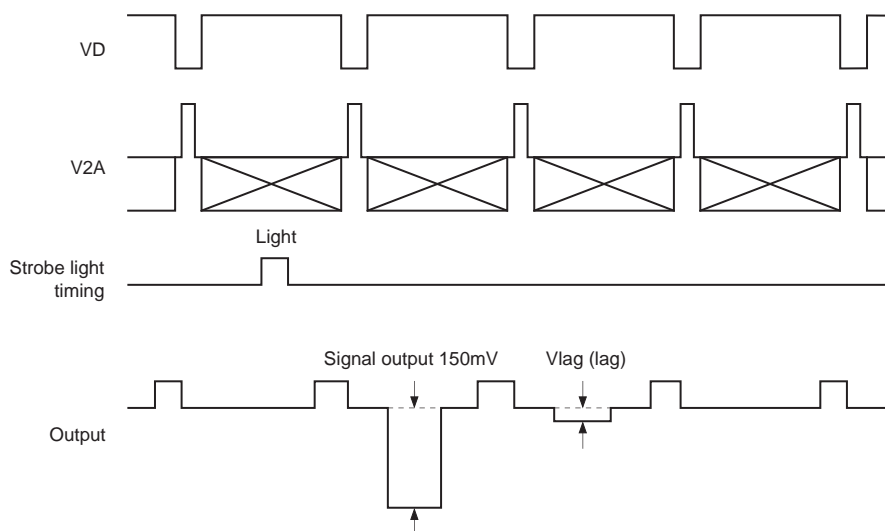

Sensor Readout Clock Timing Chart Progressive Scan Mode

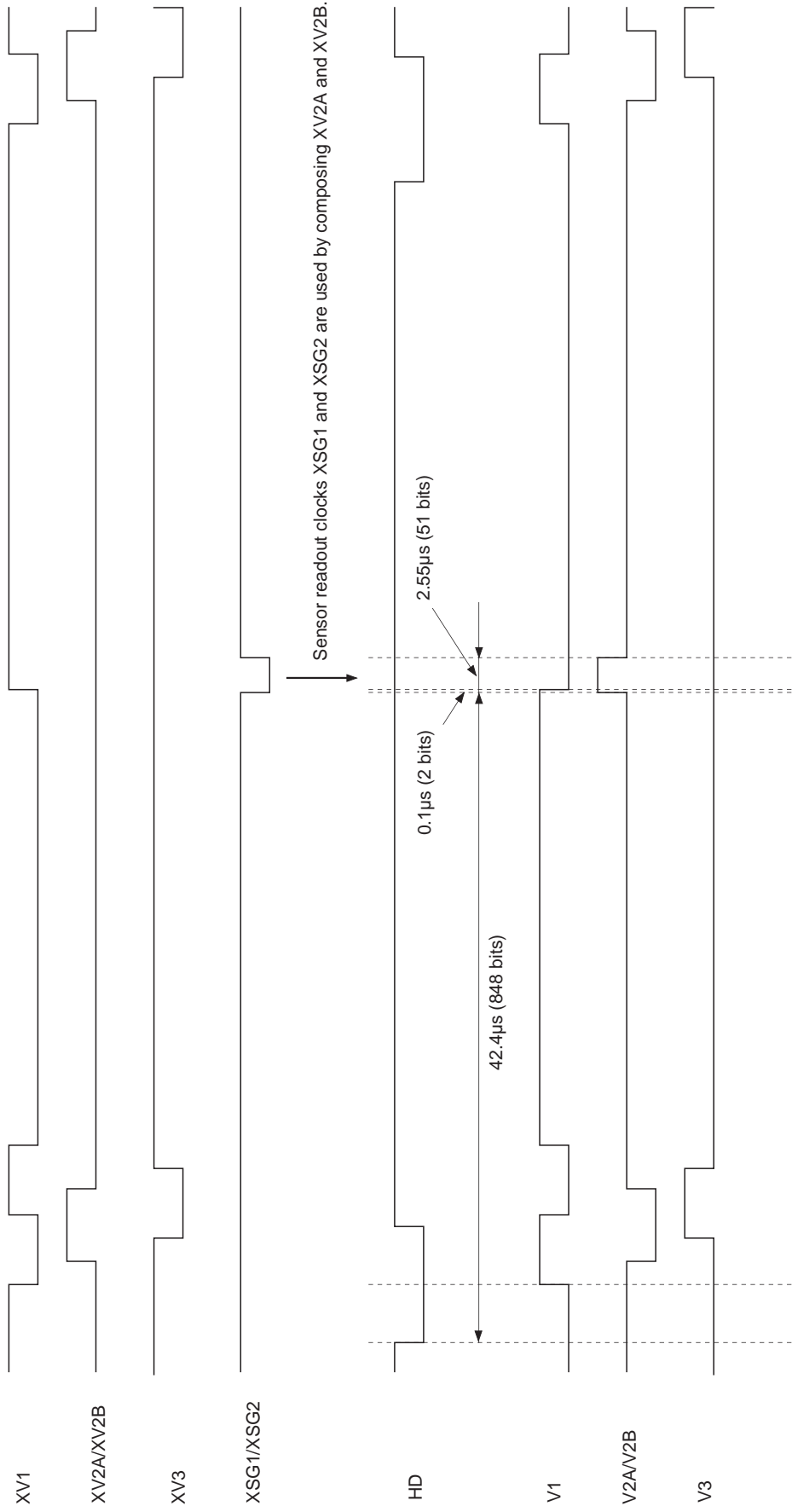

Sensor Readout Clock Timing Chart High Frame Rate Readout Mode

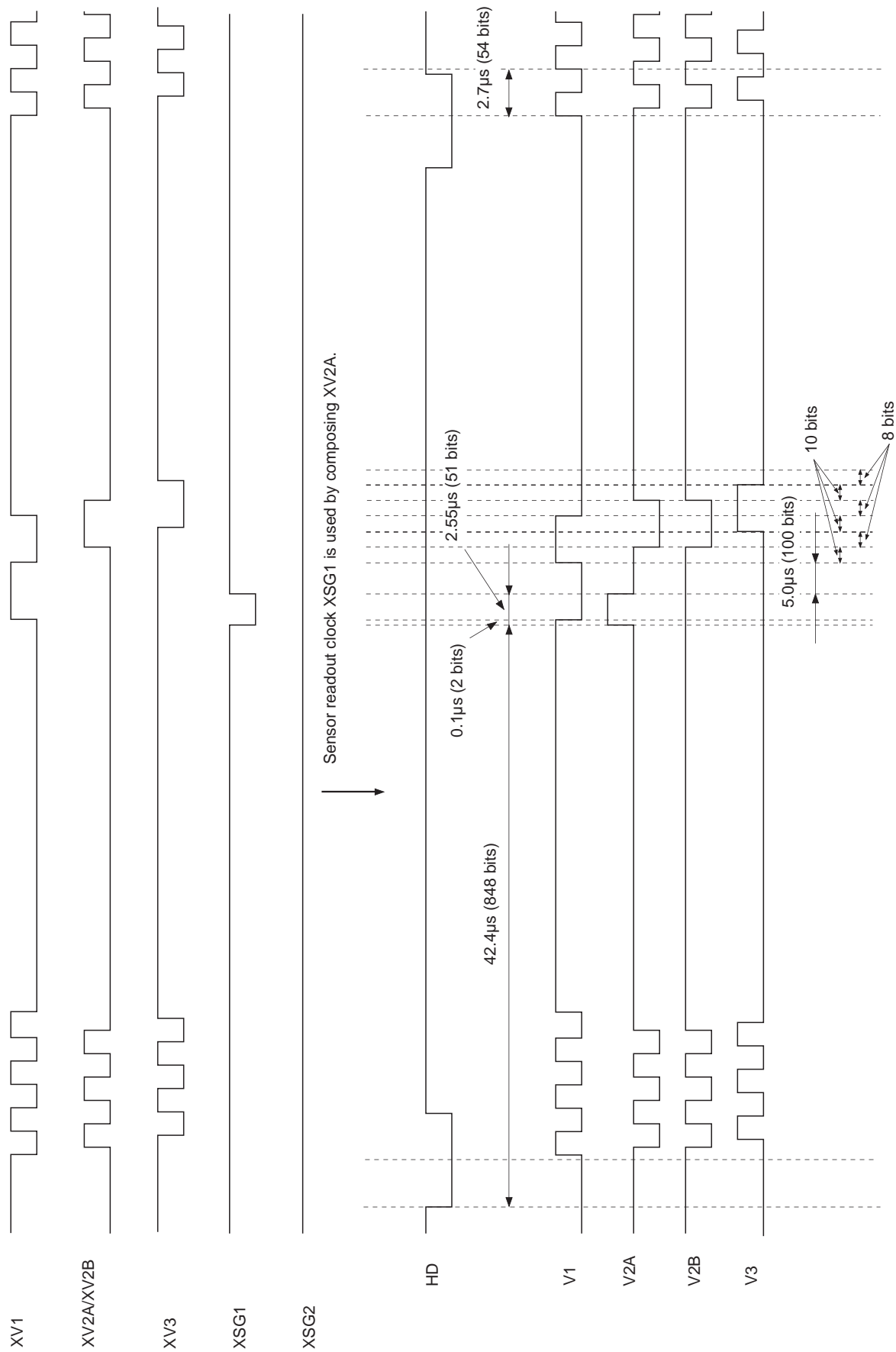

Drive Timing Chart (Vertical Sync) Progressive Scan Mode

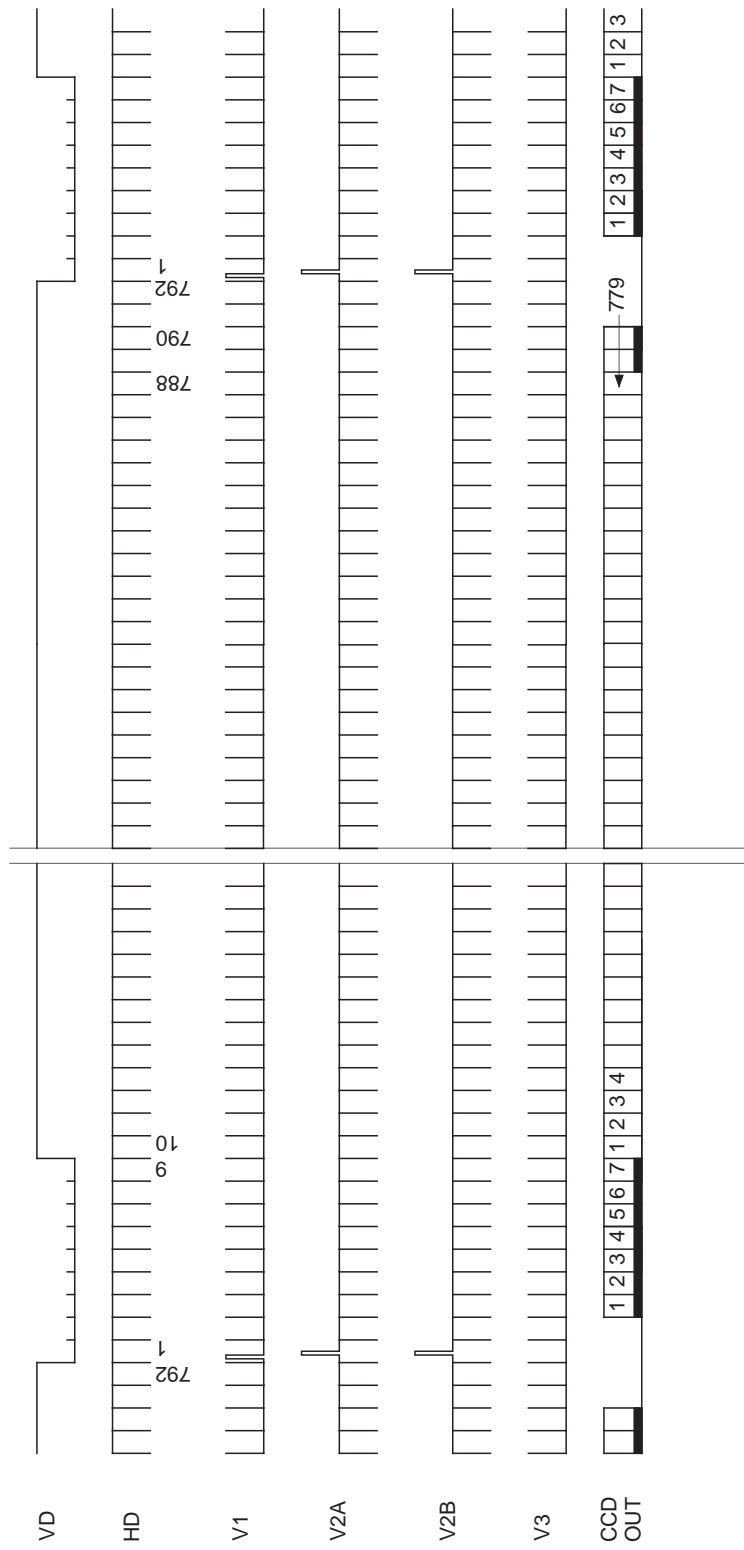

Drive Timing Chart (Vertical Sync) High Frame Rate Readout Mode

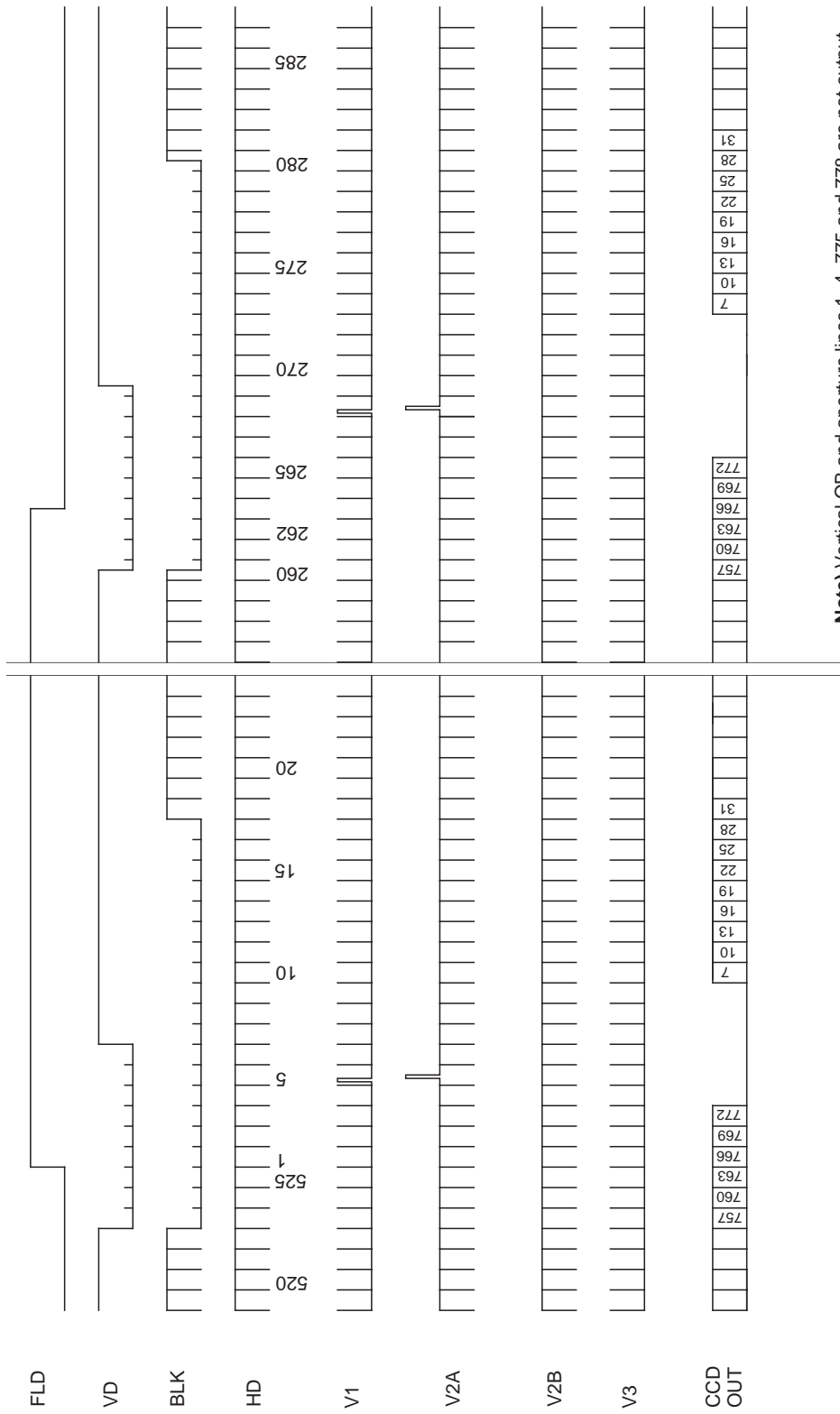

Drive Timing Chart (Horizontal Sync) Progressive Scan Mode

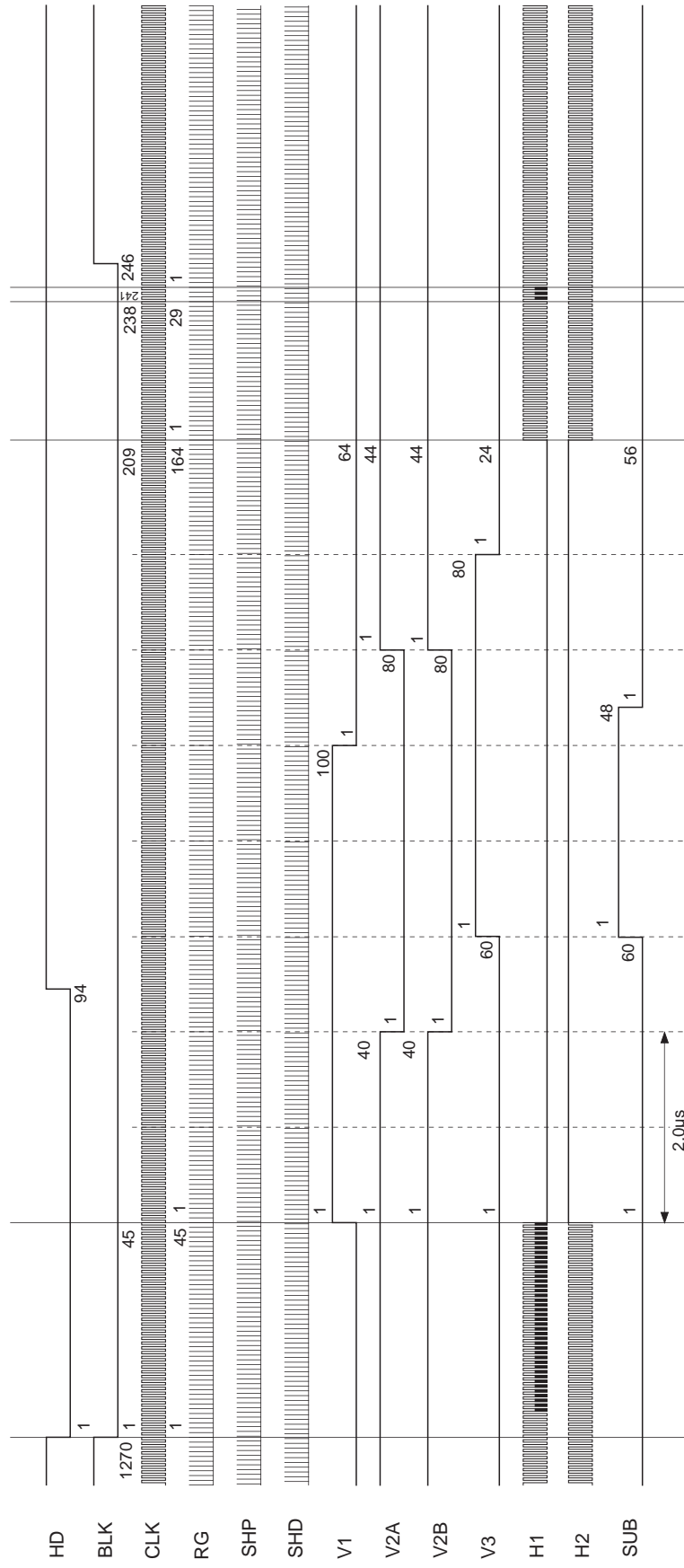

Note) 1 unit: 50ns

Drive Timing Chart (Horizontal Sync) High Frame Rate Readout Mode

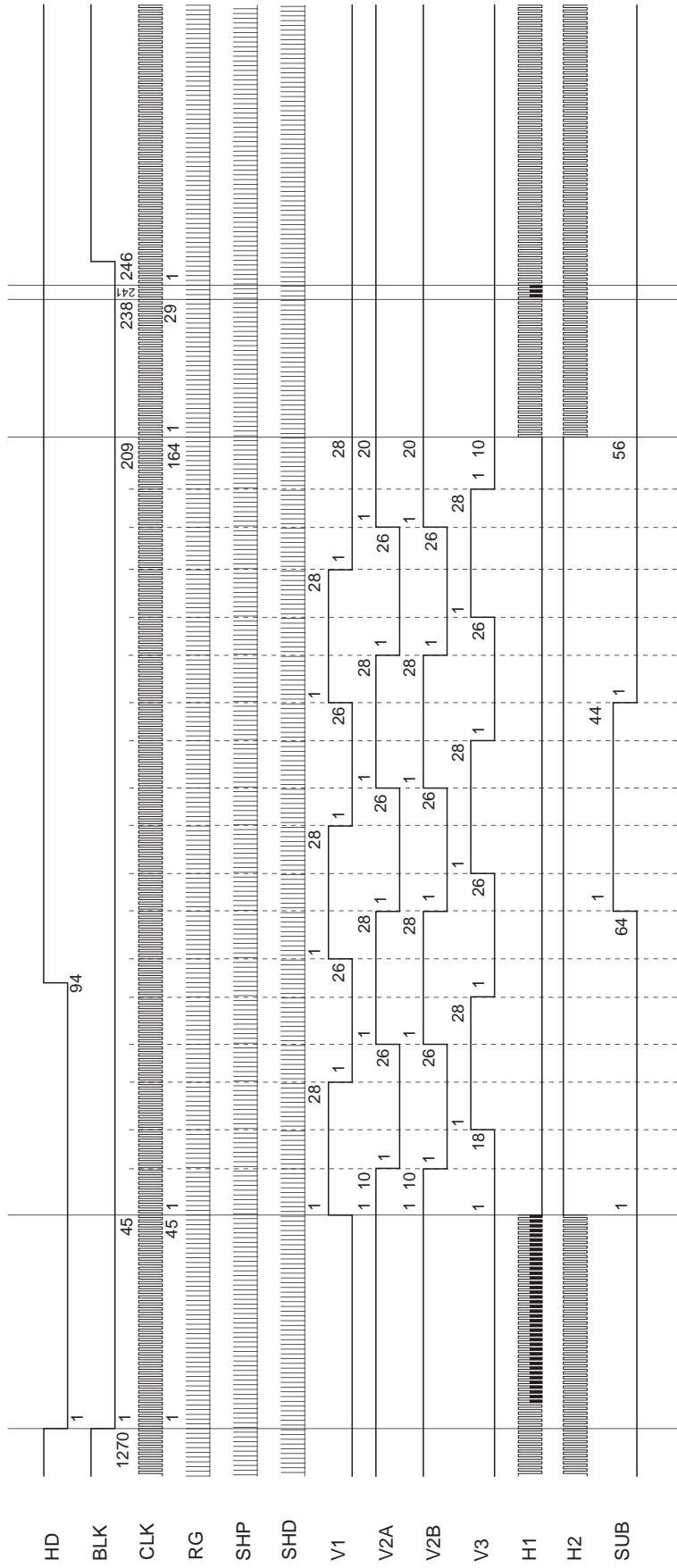

Note) 1 unit: 50ns

Notes on Handling

1) Static charge prevention

CCD image sensors are easily damaged by static discharge. Before handling be sure to take the following protective measures.

- Either handle bare handed or use non-chargeable gloves, clothes or material.
Also use conductive shoes.
- When handling directly use an earth band.
- Install a conductive mat on the floor or working table to prevent the generation of static electricity.
- Ionized air is recommended for discharge when handling CCD image sensor.
- For the shipment of mounted substrates, use boxes treated for the prevention of static charges.

2) Soldering

- Make sure the package temperature does not exceed 80°C.
- Solder dipping in a mounting furnace causes damage to the glass and other defects. Use a ground 30W soldering iron and solder each pin in less than 2 seconds. For repairs and remount, cool sufficiently.
- To dismount an image sensor, do not use a solder suction equipment. When using an electric desoldering tool, use a thermal controller of the zero cross On/Off type and connect it to ground.

3) Dust and dirt protection

Image sensors are packed and delivered by taking care of protecting its glass plates from harmful dust and dirt. Clean glass plates with the following operation as required, and use them.

- Perform all assembly operations in a clean room (class 1000 or less).
- Do not either touch glass plates by hand or have any object come in contact with glass surfaces. Should dirt stick to a glass surface, blow it off with an air blower. (For dirt stuck through static electricity ionized air is recommended.)
- Clean with a cotton bud and ethyl alcohol if the grease stained. Be careful not to scratch the glass.
- Keep in a case to protect from dust and dirt. To prevent dew condensation, preheat or precool when moving to a room with great temperature differences.
- When a protective tape is applied before shipping, just before use remove the tape applied for electrostatic protection. Do not reuse the tape.

4) Installing (attaching)

- Remain within the following limits when applying a static load to the package. Do not apply any load more than 0.7mm inside the outer perimeter of the glass portion, and do not apply any load or impact to limited portions. (This may cause cracks in the package.)

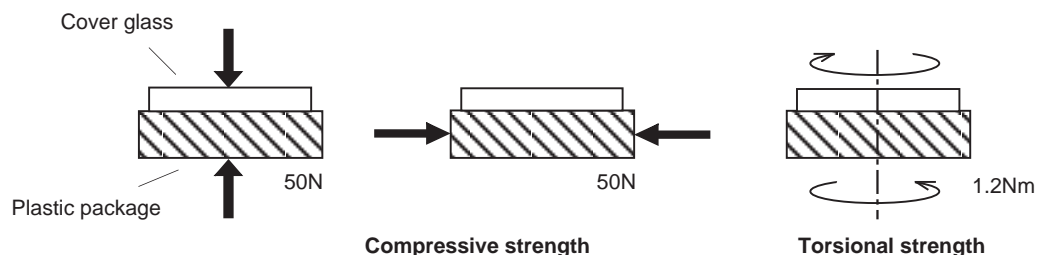

- If a load is applied to the entire surface by a hard component, bending stress may be generated and the package may fracture, etc., depending on the flatness of the bottom of the package. Therefore, for installation, use either an elastic load, such as a spring plate, or an adhesive.

- c) The adhesive may cause the marking on the rear surface to disappear, especially in case the regulated voltage value is indicated on the rear surface. Therefore, the adhesive should not be applied to this area, and indicated values should be transferred to the other locations as a precaution.
- d) The notch of the package is used for directional index, and that can not be used for reference of fixing. In addition, the cover glass and seal resin may overlap with the notch of the package.
- e) If the lead bend repeatedly and the metal, etc., clash or rub against the package, the dust may be generated by the fragments of resin.
- f) Acrylate anaerobic adhesives are generally used to attach CCD image sensors. In addition, cyanoacrylate instantaneous adhesives are sometimes used jointly with acrylate anaerobic adhesives. (reference)

5) Others

- a) Do not expose to strong light (sun rays) for long periods. For continuous using under cruel condition exceeding the normal using condition, consult our company.
- b) Exposure to high temperature or humidity will affect the characteristics. Accordingly avoid storage or usage in such conditions.
- c) The brown stain may be seen on the bottom or side of the package. But this does not affect the CCD characteristics.

