



STD30NF03L

N - CHANNEL 30V - 0.020 Ω - 30A DPAK STripFET™ POWER MOSFET

TYPE	V _{DSS}	R _{DS(on)}	I _D
STD30NF03L	30 V	< 0.025 Ω	30 A

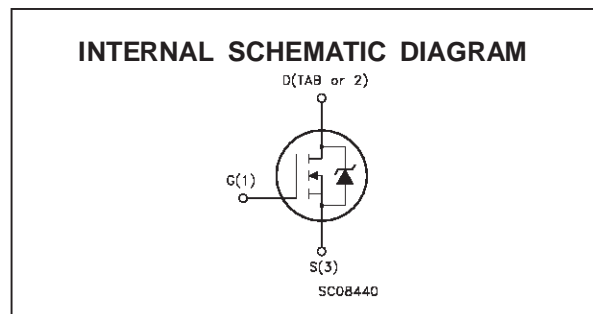
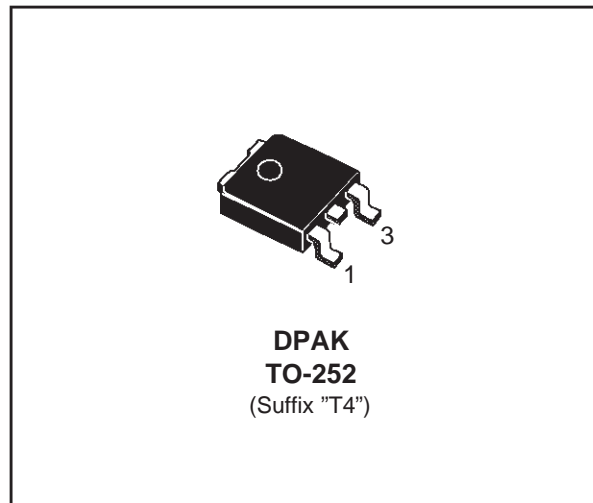
- TYPICAL R_{DS(on)} = 0.020 Ω
- LOW THRESHOLD DRIVE
- ADD SUFFIX "T4" FOR ORDERING IN TAPE & REEL

DESCRIPTION

This Power MOSFET is the latest development of STMicroelectronics unique "Single Feature Size™" strip-based process. The resulting transistor shows extremely high packing density for low on-resistance, rugged avalanche characteristics and less critical alignment steps therefore a remarkable manufacturing reproducibility.

APPLICATIONS

- HIGH CURRENT, HIGH SPEED SWITCHING
- SOLENOID AND RELAY DRIVERS
- MOTOR CONTROL, AUDIO AMPLIFIERS
- DC-DC & DC-AC CONVERTERS



ABSOLUTE MAXIMUM RATINGS

Symbol	Parameter	Value	Unit
V _{DS}	Drain-source Voltage (V _{GS} = 0)	30	V
V _{DGR}	Drain- gate Voltage (R _{GS} = 20 kΩ)	30	V
V _{GS}	Gate-source Voltage	± 20	V
I _D (●)	Drain Current (continuous) at T _c = 25 °C	30	A
I _D	Drain Current (continuous) at T _c = 100 °C	19	A
I _{DM} (●●)	Drain Current (pulsed)	120	A
P _{tot}	Total Dissipation at T _c = 25 °C	40	W
	Derating Factor	0.27	W/°C
E _{AS} (1)	Single Pulse Avalanche Energy	100	m/J
T _{stg}	Storage Temperature	-65 to 175	°C
T _j	Max. Operating Junction Temperature	175	°C

(●●) Pulse width limited by safe operating area
(●) Current limited by the package

(1) starting T_j = 25 °C, I_D = 15A, V_{DD} = 15V

STD30NF03L

THERMAL DATA

$R_{thj-pcb}$	Thermal Resistance Junction-PC Board	Max	3.75	$^{\circ}\text{C}/\text{W}$
$R_{thj-amb}$	Thermal Resistance Junction-ambient	Max	100	$^{\circ}\text{C}/\text{W}$
$R_{thj-sink}$	Thermal Resistance Case-sink	Typ	1.5	$^{\circ}\text{C}/\text{W}$
T_l	Maximum Lead Temperature For Soldering Purpose		275	$^{\circ}\text{C}$

ELECTRICAL CHARACTERISTICS ($T_{case} = 25^{\circ}\text{C}$ unless otherwise specified)

OFF

Symbol	Parameter	Test Conditions	Min.	Typ.	Max.	Unit
$V_{(BR)DSS}$	Drain-source Breakdown Voltage	$I_D = 250 \mu\text{A}$ $V_{GS} = 0$	30			V
I_{DSS}	Zero Gate Voltage Drain Current ($V_{GS} = 0$)	$V_{DS} = \text{Max Rating}$ $V_{DS} = \text{Max Rating}$ $T_c = 125^{\circ}\text{C}$			1 10	μA μA
I_{GSS}	Gate-body Leakage Current ($V_{DS} = 0$)	$V_{GS} = \pm 20 \text{ V}$			± 100	nA

ON (*)

Symbol	Parameter	Test Conditions	Min.	Typ.	Max.	Unit
$V_{GS(th)}$	Gate Threshold Voltage	$V_{DS} = V_{GS}$ $I_D = 250 \mu\text{A}$	1	1.7	2.5	V
$R_{DS(on)}$	Static Drain-source On Resistance	$V_{GS} = 10 \text{ V}$ $I_D = 15 \text{ A}$ $V_{GS} = 4.5 \text{ V}$ $I_D = 15 \text{ A}$		0.020 0.028	0.025 0.035	Ω Ω
$I_{D(on)}$	On State Drain Current	$V_{DS} > I_{D(on)} \times R_{DS(on)max}$ $V_{GS} = 10 \text{ V}$	30			A

DYNAMIC

Symbol	Parameter	Test Conditions	Min.	Typ.	Max.	Unit
$g_{fs} (*)$	Forward Transconductance	$V_{DS} > I_{D(on)} \times R_{DS(on)max}$ $I_D = 15 \text{ A}$		13		S
C_{iss}	Input Capacitance	$V_{DS} = 25 \text{ V}$ $f = 1 \text{ MHz}$ $V_{GS} = 0 \text{ V}$		830		pF
C_{oss}	Output Capacitance			230		pF
C_{rss}	Reverse Transfer Capacitance			92		pF

ELECTRICAL CHARACTERISTICS (continued)

SWITCHING ON

Symbol	Parameter	Test Conditions	Min.	Typ.	Max.	Unit
$t_{d(on)}$	Turn-on Delay Time	$V_{DD} = 15\text{ V}$ $I_D = 20\text{ A}$ $R_G = 4.7\ \Omega$ $V_{GS} = 4.5\text{ V}$ (Resistive Load, see fig. 3)		35		ns
t_r	Rise Time			205		ns
Q_g	Total Gate Charge	$V_{DD} = 24\text{ V}$ $I_D = 30\text{ A}$ $V_{GS} = 5\text{ V}$		18		nC
Q_{gs}	Gate-Source Charge			7		nC
Q_{gd}	Gate-Drain Charge			8		nC

SWITCHING OFF

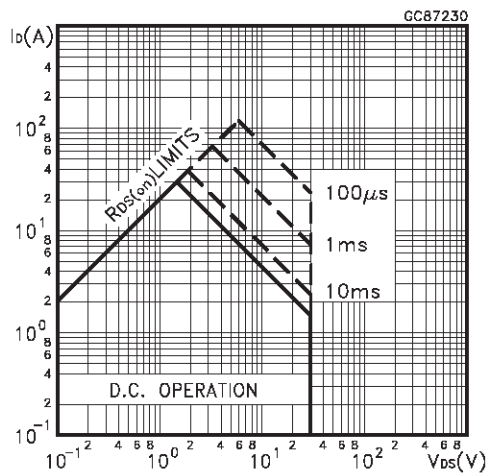
Symbol	Parameter	Test Conditions	Min.	Typ.	Max.	Unit
$t_{d(off)}$	Turn-off Delay Time	$V_{DD} = 15\text{ V}$ $I_D = 20\text{ A}$ $R_G = 4.7\ \Omega$ $V_{GS} = 4.5\text{ V}$ (Resistive Load, see fig. 3)		90		ns
t_f	Fall Time			240		ns

SOURCE DRAIN DIODE

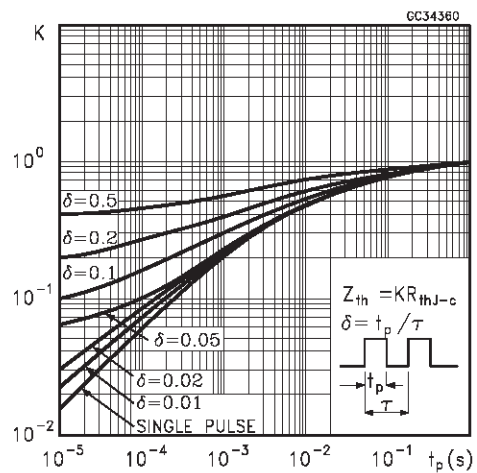
Symbol	Parameter	Test Conditions	Min.	Typ.	Max.	Unit
I_{SD}	Source-drain Current				30	A
$I_{SDM}(\bullet)$	Source-drain Current (pulsed)				120	A
$V_{SD} (*)$	Forward On Voltage	$I_{SD} = 30\text{ A}$ $V_{GS} = 0$			1.5	V
t_{rr}	Reverse Recovery Time	$I_{SD} = 40\text{ A}$ $di/dt = 100\text{ A}/\mu\text{s}$ $V_{DD} = 15\text{ V}$ $T_j = 150\text{ }^\circ\text{C}$ (see test circuit, fig. 5)		65		ns
Q_{rr}	Reverse Recovery Charge			72		nC
I_{RRM}	Reverse Recovery Current			2		A

(*) Pulsed: Pulse duration = 300 μs , duty cycle 1.5 %
 (•) Pulse width limited by safe operating area

Safe Operating Area

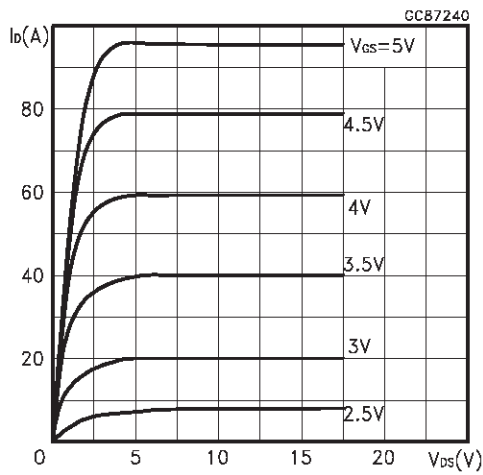


Thermal Impedance

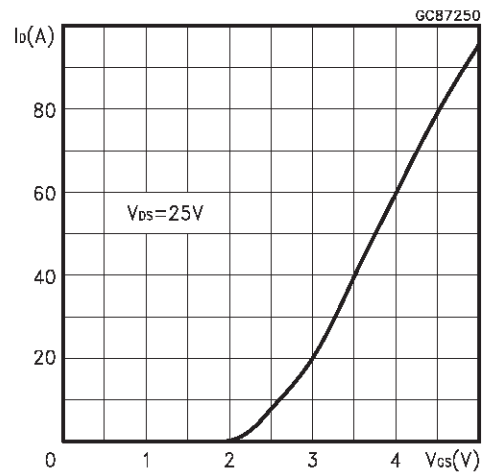


STD30NF03L

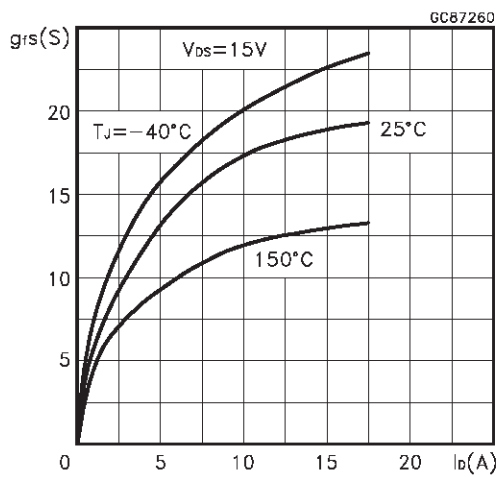
Output Characteristics



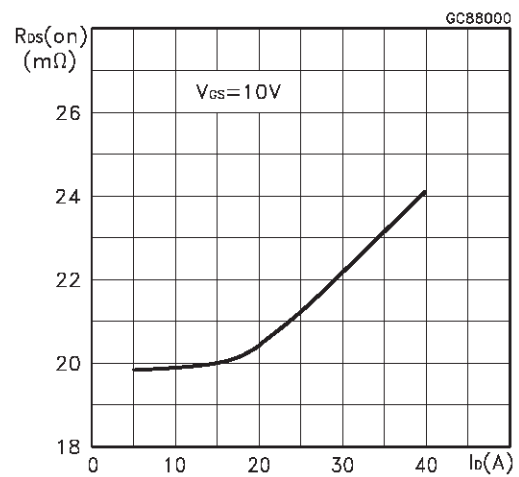
Transfer Characteristics



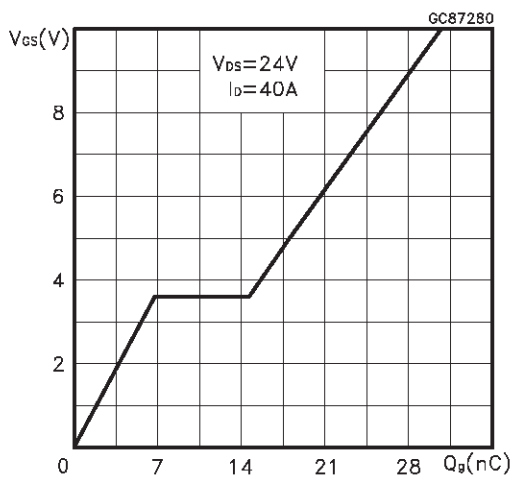
Transconductance



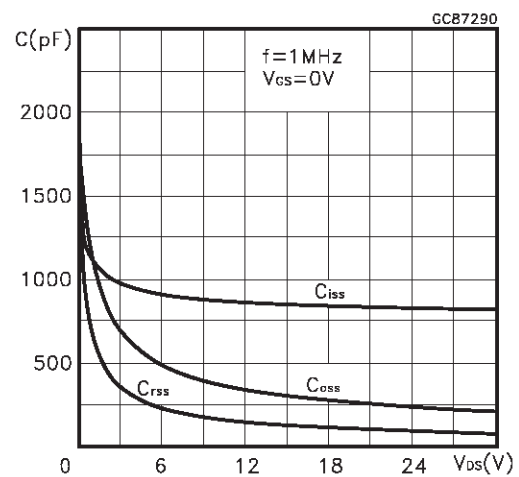
Static Drain-source On Resistance



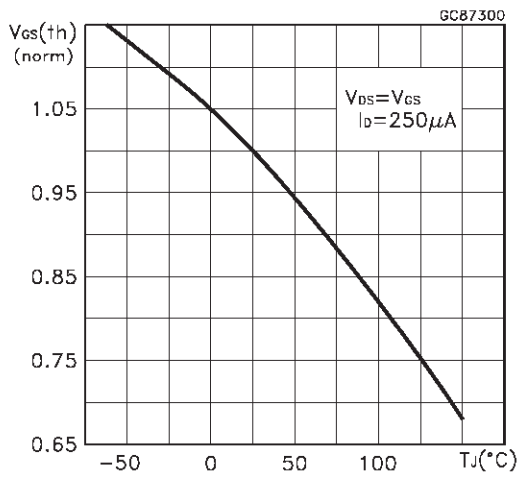
Gate Charge vs Gate-source Voltage



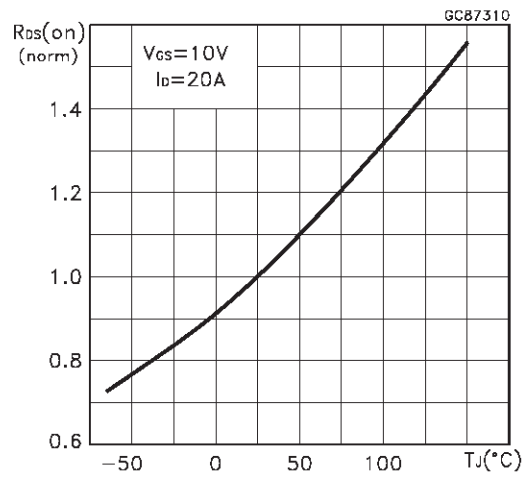
Capacitance Variations



Normalized Gate Threshold Voltage vs Temperature



Normalized On Resistance vs Temperature



Source-drain Diode Forward Characteristics

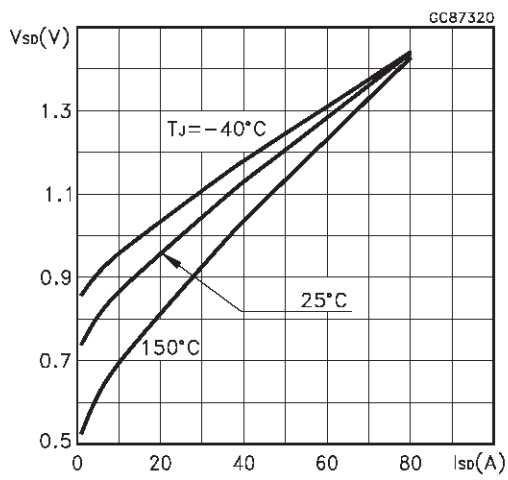


Fig. 1: Unclamped Inductive Load Test Circuit



Fig. 2: Unclamped Inductive Waveform



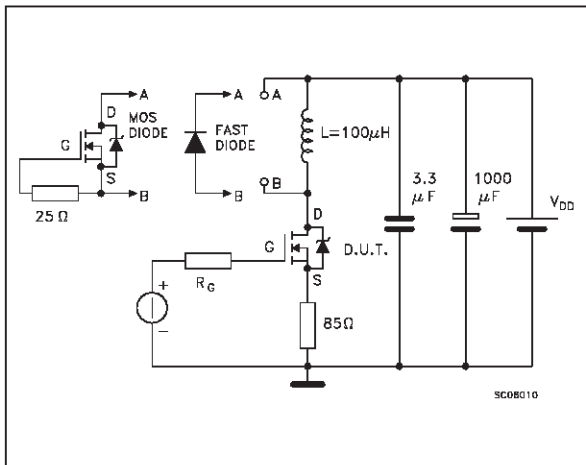
Fig. 3: Switching Times Test Circuits For Resistive Load



Fig. 4: Gate Charge test Circuit

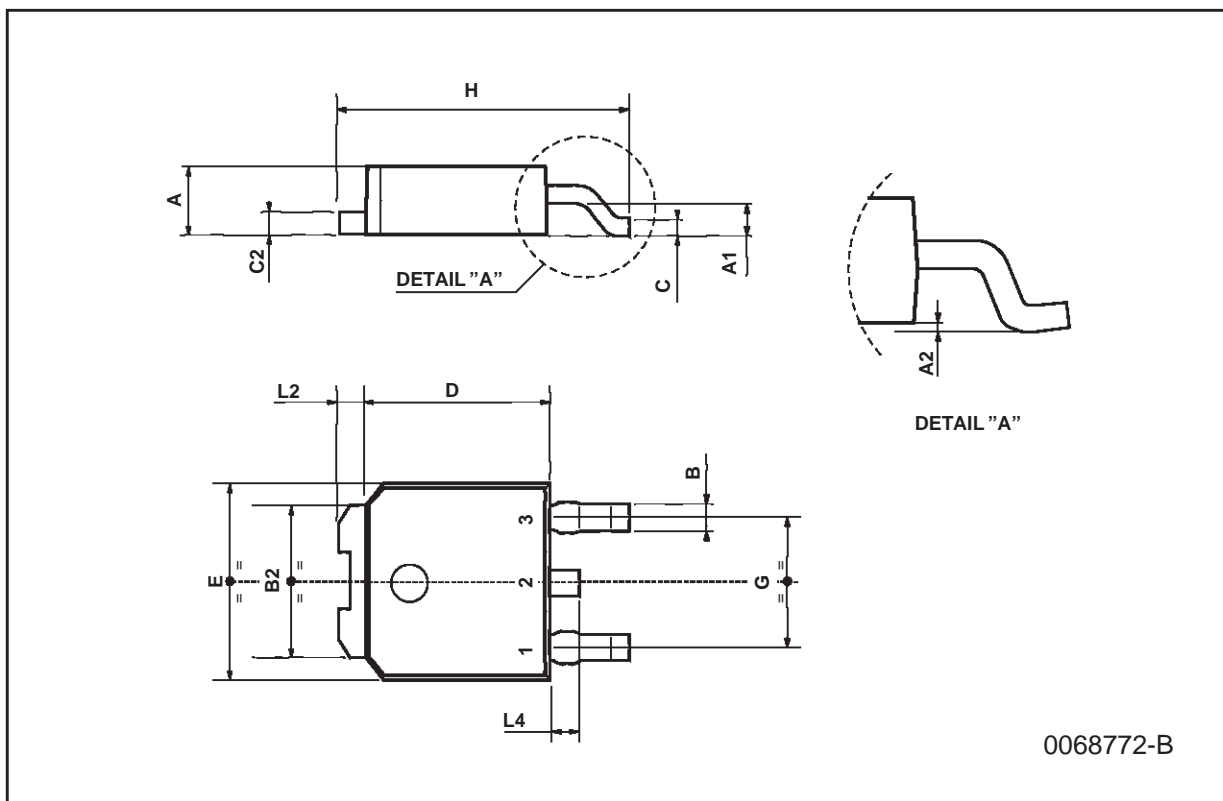


Fig. 5: Test Circuit For Inductive Load Switching And Diode Recovery Times



TO-252 (DPAK) MECHANICAL DATA

DIM.	mm			inch		
	MIN.	TYP.	MAX.	MIN.	TYP.	MAX.
A	2.2		2.4	0.086		0.094
A1	0.9		1.1	0.035		0.043
A2	0.03		0.23	0.001		0.009
B	0.64		0.9	0.025		0.035
B2	5.2		5.4	0.204		0.212
C	0.45		0.6	0.017		0.023
C2	0.48		0.6	0.019		0.023
D	6		6.2	0.236		0.244
E	6.4		6.6	0.252		0.260
G	4.4		4.6	0.173		0.181
H	9.35		10.1	0.368		0.397
L2		0.8			0.031	
L4	0.6		1	0.023		0.039



Information furnished is believed to be accurate and reliable. However, STMicroelectronics assumes no responsibility for the consequences of use of such information nor for any infringement of patents or other rights of third parties which may result from its use. No license is granted by implication or otherwise under any patent or patent rights of STMicroelectronics. Specification mentioned in this publication are subject to change without notice. This publication supersedes and replaces all information previously supplied. STMicroelectronics products are not authorized for use as critical components in life support devices or systems without express written approval of STMicroelectronics.

The ST logo is a trademark of STMicroelectronics

© 1999 STMicroelectronics – Printed in Italy – All Rights Reserved
STMicroelectronics GROUP OF COMPANIES

Australia - Brazil - China - Finland - France - Germany - Hong Kong - India - Italy - Japan - Malaysia - Malta - Morocco -
Singapore - Spain - Sweden - Switzerland - United Kingdom - U.S.A.