HD74HC75

Quad. Bistable Latches

HITACHI

Description

This latch is ideally suited for use as temporary storage for binary information processing, input/output, and indicator units. Information present at the data (D) input is transferred to the Q output when the latch enable (LE) is high. The Q output will follow the data input as long as the enable remains high. When the enable goes low, the information that was present at the data input at the time the transition occurred is retained at the Q output until the enable is permitted to go high again.

Features

- High Speed Operation: t_{pd} (D to Q) = 12.5 ns typ ($C_L = 50$ pF)
- High Output Current: Fanout of 10 LSTTL Loads
- Wide Operating Voltage: $V_{CC} = 2$ to 6 V
- Low Input Current: 1 μ A max
- Low Quiescent Supply Current: I_{CC} (static) = 2 μ A max ($T_a = 25^\circ\text{C}$)

Function Table

Inputs		Outputs	
D	Latch Enable	Q	\bar{Q}
L	H	L	H
H	H	H	L
X	L	Q_0	\bar{Q}_0

HD74HC75

Pin Arrangement

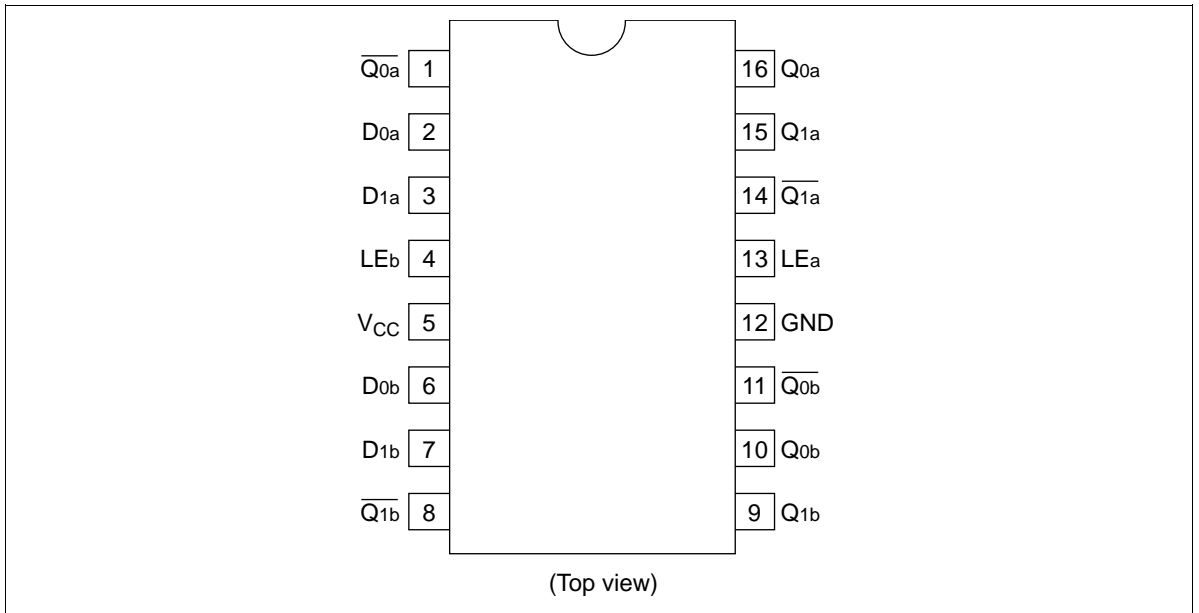

Block Diagram

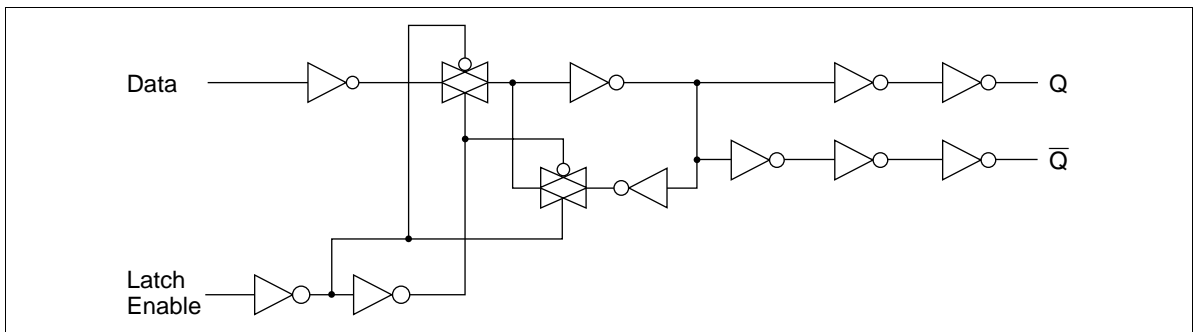

DC Characteristics

Item	Symbol	V _{CC} (V)	Ta = 25°C			Ta = -40 to +85°C		Unit	Test Conditions	
			Min	Typ	Max	Min	Max			
Input voltage	V _{IH}	2.0	1.5	—	—	1.5	—	V		
		4.5	3.15	—	—	3.15	—			
		6.0	4.2	—	—	4.2	—			
	V _{IL}	2.0	—	—	0.5	—	0.5			V
		4.5	—	—	1.35	—	1.35			
		6.0	—	—	1.8	—	1.8			
Output voltage	V _{OH}	2.0	1.9	2.0	—	1.9	—	V	Vin = V _{IH} or V _{IL} I _{OH} = -20 μA	
		4.5	4.4	4.5	—	4.4	—			
		6.0	5.9	6.0	—	5.9	—			
		4.5	4.18	—	—	4.13	—			I _{OH} = -4 mA
		6.0	5.68	—	—	5.63	—			I _{OH} = -5.2 mA
		6.0	—	0.0	0.1	—	0.1			V
	4.5	—	0.0	0.1	—	0.1				
	6.0	—	0.0	0.1	—	0.1				
	4.5	—	—	0.26	—	0.33	I _{OL} = 4 mA			
	6.0	—	—	0.26	—	0.33	I _{OL} = 5.2 mA			
Input current	I _{in}	6.0	—	—	±0.1	—	±1.0	μA	Vin = V _{CC} or GND	
Quiescent supply current	I _{CC}	6.0	—	—	2.0	—	20	μA	Vin = V _{CC} or GND, I _{out} = 0 μA	

HD74HC75

AC Characteristics ($C_L = 50$ pF, Input $t_r = t_f = 6$ ns)

Item	Symbol	V_{CC} (V)	Ta = 25°C		Ta = -40 to +85°C		Unit	Test Conditions		
			Min	Typ	Max	Min			Max	
Propagation delay time	t_{PLH}	2.0	—	—	125	—	155	ns	D to Q	
		4.5	—	12	25	—	31			
		6.0	—	—	21	—	26			
	t_{PHL}	2.0	—	—	110	—	140	ns	D to \bar{Q}	
		4.5	—	13	22	—	28			
		6.0	—	—	19	—	24			
		2.0	—	—	145	—	180			Latch Enable to Q
		4.5	—	12	29	—	36			
		6.0	—	—	25	—	31			
	t_{THL}	2.0	—	—	125	—	155	ns	Latch Enable to \bar{Q}	
		4.5	—	13	25	—	31			
		6.0	—	—	21	—	26			
Output rise/fall time	t_{TLH}	2.0	—	—	75	—	95	ns		
		4.5	—	5	15	—	19			
		6.0	—	—	13	—	16			
Setup time	t_{su}	2.0	100	—	—	125	—	ns	Data to Latch Enable	
		4.5	20	4	—	25	—			
		6.0	17	—	—	21	—			
Hold time	t_h	2.0	5	—	—	5	—	ns	Latch Enable to Data	
		4.5	5	0	—	5	—			
		6.0	5	—	—	5	—			
Pulse width	t_w	2.0	80	—	—	100	—	ns	Latch Enable	
		4.5	16	5	—	20	—			
		6.0	14	—	—	17	—			
Input capacitance	C_{in}	—	—	5	10	—	10	pF		

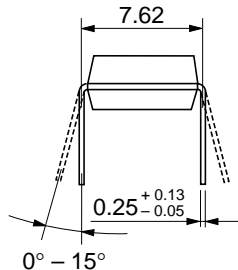
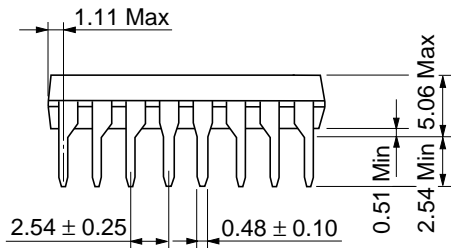
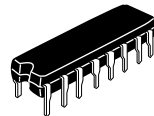
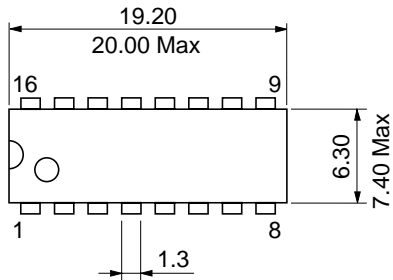

Hitachi Code	DP-16
JEDEC	Conforms
EIAJ	Conforms
Weight (reference value)	1.07 g

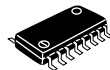

*Dimension including the plating thickness
Base material dimension

Hitachi Code	FP-16DA
JEDEC	—
EIAJ	Conforms
Weight (reference value)	0.24 g



*Dimension including the plating thickness
Base material dimension

Hitachi Code	FP-16DN
JEDEC	Conforms
EIAJ	Conforms
Weight (reference value)	0.15 g

Cautions

1. Hitachi neither warrants nor grants licenses of any rights of Hitachi's or any third party's patent, copyright, trademark, or other intellectual property rights for information contained in this document. Hitachi bears no responsibility for problems that may arise with third party's rights, including intellectual property rights, in connection with use of the information contained in this document.
2. Products and product specifications may be subject to change without notice. Confirm that you have received the latest product standards or specifications before final design, purchase or use.
3. Hitachi makes every attempt to ensure that its products are of high quality and reliability. However, contact Hitachi's sales office before using the product in an application that demands especially high quality and reliability or where its failure or malfunction may directly threaten human life or cause risk of bodily injury, such as aerospace, aeronautics, nuclear power, combustion control, transportation, traffic, safety equipment or medical equipment for life support.
4. Design your application so that the product is used within the ranges guaranteed by Hitachi particularly for maximum rating, operating supply voltage range, heat radiation characteristics, installation conditions and other characteristics. Hitachi bears no responsibility for failure or damage when used beyond the guaranteed ranges. Even within the guaranteed ranges, consider normally foreseeable failure rates or failure modes in semiconductor devices and employ systemic measures such as fail-safes, so that the equipment incorporating Hitachi product does not cause bodily injury, fire or other consequential damage due to operation of the Hitachi product.
5. This product is not designed to be radiation resistant.
6. No one is permitted to reproduce or duplicate, in any form, the whole or part of this document without written approval from Hitachi.
7. Contact Hitachi's sales office for any questions regarding this document or Hitachi semiconductor products.

HITACHI

Hitachi, Ltd.

Semiconductor & Integrated Circuits.
Nippon Bldg., 2-6-2, Ohte-machi, Chiyoda-ku, Tokyo 100-0004, Japan
Tel: Tokyo (03) 3270-2111 Fax: (03) 3270-5109

URL North America : <http://semiconductor.hitachi.com/>
Europe : <http://www.hitachi-eu.com/hel/ecg>
Asia (Singapore) : <http://www.has.hitachi.com.sg/grp3/sicd/index.htm>
Asia (Taiwan) : http://www.hitachi.com.tw/E/Product/SICD_Frame.htm
Asia (HongKong) : <http://www.hitachi.com.hk/eng/bo/grp3/index.htm>
Japan : <http://www.hitachi.co.jp/Sicd/indx.htm>

For further information write to:

Hitachi Semiconductor
(America) Inc.
179 East Tasman Drive,
San Jose, CA 95134
Tel: <1> (408) 433-1990
Fax: <1> (408) 433-0223

Hitachi Europe GmbH
Electronic components Group
Dornacher Straße 3
D-85622 Feldkirchen, Munich
Germany
Tel: <49> (89) 9 9180-0
Fax: <49> (89) 9 29 30 00

Hitachi Europe Ltd.
Electronic Components Group.
Whitebrook Park
Lower Cookham Road
Maidenhead
Berkshire SL6 8YA, United Kingdom
Tel: <44> (1628) 585000
Fax: <44> (1628) 778322

Hitachi Asia Pte. Ltd.
16 Collyer Quay #20-00
Hitachi Tower
Singapore 049318
Tel: 535-2100
Fax: 535-1533

Hitachi Asia Ltd.
Taipei Branch Office
3F, Hung Kuo Building, No.167,
Tun-Hwa North Road, Taipei (105)
Tel: <886> (2) 2718-3666
Fax: <886> (2) 2718-8180

Hitachi Asia (Hong Kong) Ltd.
Group III (Electronic Components)
7/F., North Tower, World Finance Centre,
Harbour City, Canton Road, Tsim Sha Tsui,
Kowloon, Hong Kong
Tel: <852> (2) 735 9218
Fax: <852> (2) 730 0281
Telex: 40815 HITEC HX

Copyright ' Hitachi, Ltd., 1999. All rights reserved. Printed in Japan.

HITACHI