



## LA4581MB

### Preamplifier + Power Amplifier for 3V Headphone Stereos

## Overview

The LA4581MB is an auto reverse-supported preamplifier + power amplifier IC that is intended for use in 3V headphone stereos.

## Features

- Preamplifier muting and preamplifier output on/off can be implemented with one pin. This IC can easily be used to construct a set with a radio.
- The power amplifier needs no input/output coupling capacitor.
- A high-frequency cut capacitor is connected to the preamplifier input pin and the power amplifier input pin. (Anti-buzz provision)
- Because  $V_{ref}$  AMP ( $r_0 = 10 \Omega$ ) is built in, the virtual grounding impedance is about  $10 \Omega$ . This eliminates the need for a large capacitor.
- $8 \Omega$  speaker drivable.

## Package Dimensions

unit : mm

### 3112-MFP24S

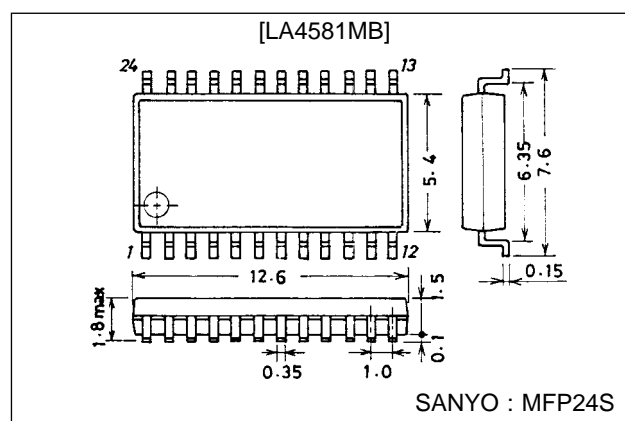

## Specifications

### Maximum Ratings at $T_a = 25^\circ\text{C}$

Parameter	Symbol	Conditions	Ratings	Unit
Maximum supply voltage	$V_{CC \text{ max}}$		4.5	V
Allowable power dissipation	$P_d \text{ max}$		530	mW
Operating temperature	$T_{opr}$		-20 to +75	$^\circ\text{C}$
Storage temperature	$T_{stg}$		-40 to +125	$^\circ\text{C}$

### Operating Conditions at $T_a = 25^\circ\text{C}$

Parameter	Symbol	Conditions	Ratings	Unit
Recommended supply voltage	$V_{CC}$		3.0	V
Operating supply voltage range	$V_{CC \text{ op}}$		1.8 to 3.6	V

### Operating Characteristics at $T_a = 25^\circ\text{C}$ , $V_{CC} = 3.0 \text{ V}$ , $f = 1 \text{ kHz}$ , $0.775 \text{ V} = 0 \text{ dBm}$ , $R_L = 10 \text{ k}\Omega$ (preamplifier), $R_L = 16 \Omega$ (power amplifier)

Parameter	Symbol	Output				Unit
			min	typ	max	
[Pre + Power]						
Quiescent current	$I_{CCO}$	$R_g = 2.2 \text{ k}\Omega$ (preamplifier) $V_{IN} = 0 \text{ V}$		17	27	mA
Voltage gain (Closed)	$V_{GT}$	$V_O = -5 \text{ dBm}$	65	68	71	dB

Continued on next page.

# LA4581MB

Continued from preceding page.

Parameter	Symbol	Output	min	typ	max	Unit
<b>[Preamplifier]</b>						
Voltage gain (Open)	VG0	$V_O = -5$ dBm	70	80		dB
Voltage gain (Closed)	VG1	$V_O = -5$ dBm		40		dB
Maximum output voltage	$V_{Omax}$	THD = 1 %, $V_{CC} = 1.8$ V	0.1	0.2		V
Total harmonic distortion	THD1	$V_O = 0.2$ V, $V_G = 40$ dB/NAB		0.05	0.5	%
Equivalent input noise voltage	$V_{N1}$	$R_g = 2.2$ k $\Omega$ , B.P.F = 20 to 20 kHz		1.3	2.0	$\mu$ V
Crosstalk	CT1	$R_g = 2.2$ k $\Omega$ , TUNE 1 kHz	60	80		dB
Ripple rejection ratio	$R_{r1}$	$R_g = 2.2$ k $\Omega$ , $V_{CC} = 1.8$ V, $V_r = -20$ dBm, $f = 100$ Hz	40	50		dB
<b>[Power Amplifier]</b>						
Output voltage	$P_O$	THD = 10%	23	32		mW
Voltage gain (Closed)	VG2	$V_O = -5$ dBm	25	28	31	dB
Total harmonic distortion	THD2	$P_O = 1$ mW		0.4	1.0	%
Interchannel crosstalk	$CT_T$	$V_O = -5$ dBm, $R_V = 0$ $\Omega$	30	40		dB
Output noise voltage	$V_{NO}$	$R_g = 0$ , B.P.F = 20 to 20 kHz		24	40	$\mu$ V
Ripple rejection ratio	$R_{r2}$	$R_g = 0$ , $V_r = -20$ dB, $f = 100$ Hz, $V_{CC} = 1.8$ V	45	60		dB
Input resistance	$R_{IN}$		22	30	38	k $\Omega$
DC offset voltage	$V_{ODCoff}$	Between 13-14 and 15	-90		+90	mV

Note) Power amplifier voltage gain VG2 increases by about 1 dB for min/max respectively than specified above when  $R_L = 32$   $\Omega$ .

## Block Diagram

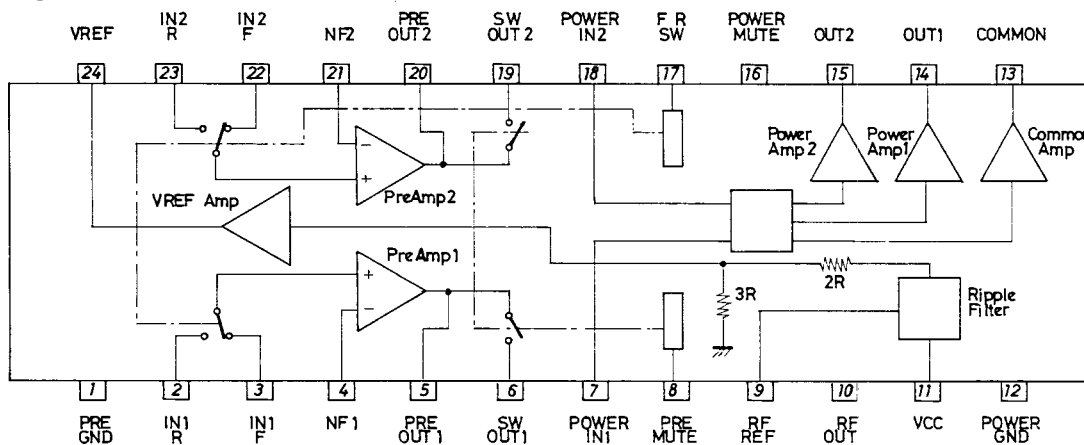

## Test Circuit

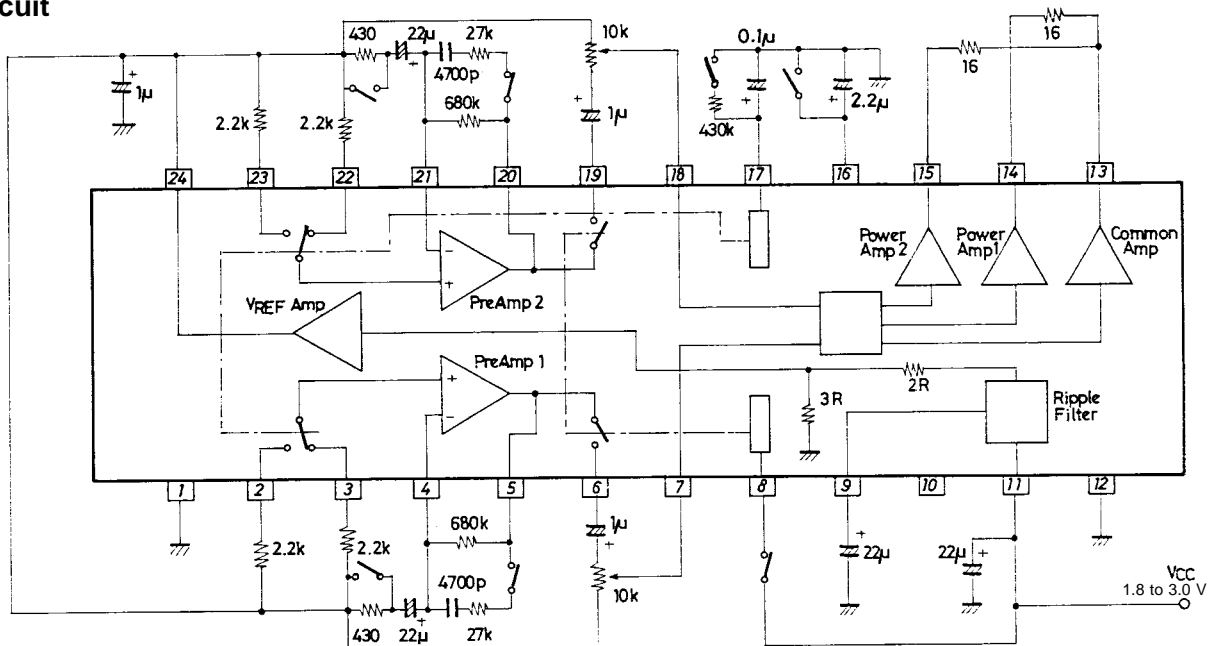

Unit (resistance:  $\Omega$ , capacitance: F)

# LA4581MB

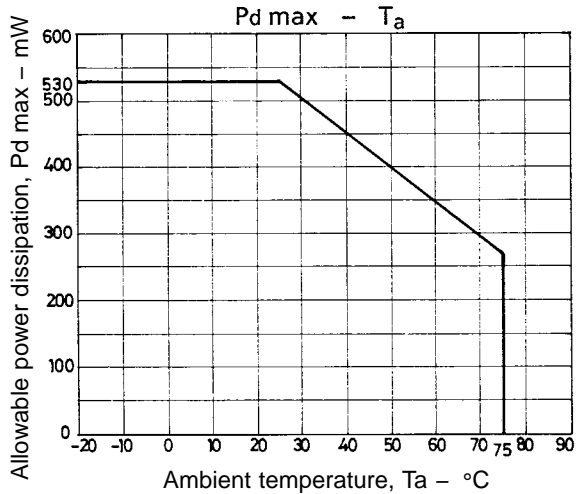

## Sample Application Circuit

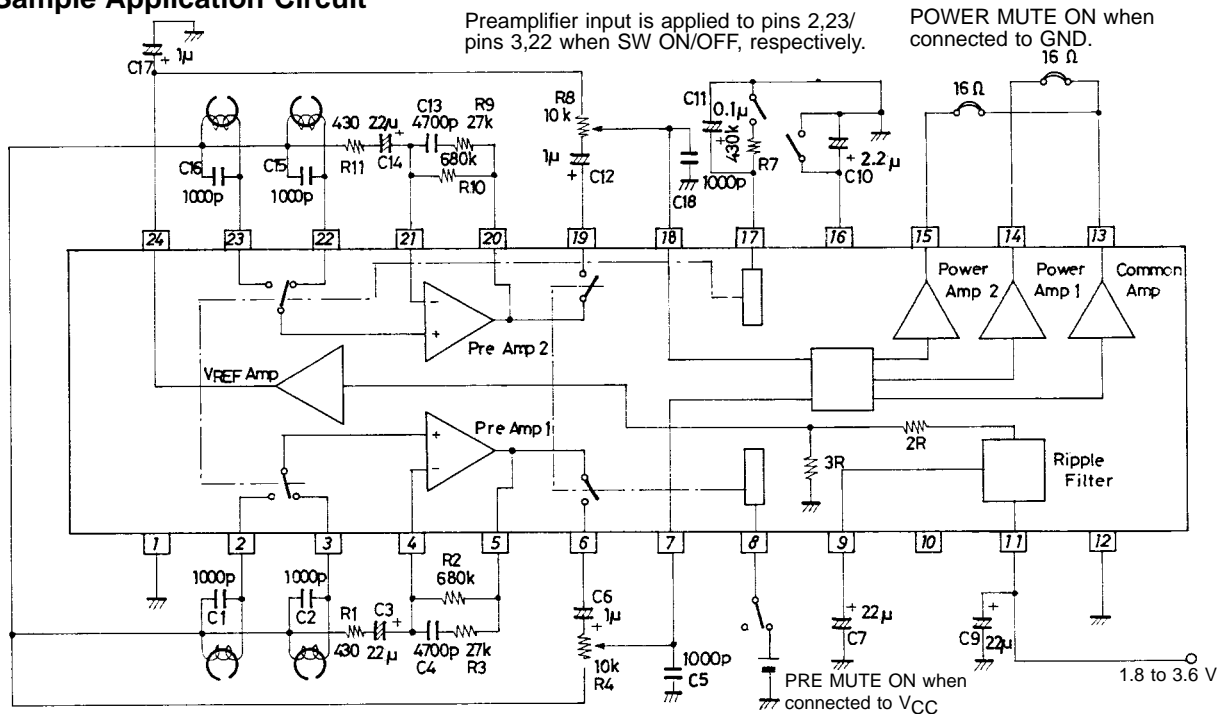

Note) Pre closed loop gain VG = 40 dB/1 kHz NAB

Unit (resistance: Ω, capacitance: F)

## Pin and external part functions (when the voltage is V<sub>CC</sub> = 3.0 V)

Pin No.	Pin Function
1	PRE GND
2	PRE IN1R 1.8 V • Turns ON when pin 17 is grounded. • A bias resistor (2.2 kΩ) must be connected between pin 2 and pin 24 (V <sub>ref</sub> ) when no head is in use.
3	PRE IN1F 1.8 V • Turns ON when pin 17 is floating. • A bias resistor (2.2 kΩ) must be connected between pin 3 and pin 24 (V <sub>ref</sub> ) when no head is in use.
4	PRE NF1 1.8 V
5	PRE OUT1 1.8 V • Like pin 6, 10 kΩ load drivable.
6	SW OUT1 1.8V • Provides PRE AMP1 output when pin 8 is floating (PRE MUTE OFF)(equivalent to pin 5). • Disconnects from PRE AMP1 and sets R <sub>IN</sub> ≥ 500 kΩ when pin 8 is at V <sub>CC</sub> (PRE MUTE ON).
7	POWER IN1 1.8V • Input resistance R <sub>IN</sub> = 30 kΩ

Continued on next page.

# LA4581MB

Continued from preceding page.

Pin No.	Pin Function
8	PRE MUTE <ul style="list-style-type: none"> <li>When <math>V_{CC}</math> is applied, PRE MUTE ON.</li> <li>MUTE ON conditions: <math>V_{8IN} \geq V_{CC} - 0.2</math> V, inflow current <math>I_7 \doteq 60</math> <math>\mu</math>A (when <math>V_{CC} = 3</math> V)</li> </ul>
9	Ripple Filter REF 2.7 V ( $C_7 = 2.2$ $\mu$ F to 33 $\mu$ F) <ul style="list-style-type: none"> <li>Ripple Filter, <math>V_{ref}</math> reference</li> <li>The <math>V_{ref}</math> ripple rejection ratio worsens when <math>C_7</math> is made smaller.</li> <li><math>R_r</math> is 55 dB for 22 <math>\mu</math>F; 35 dB for 2.2 <math>\mu</math>F.</li> </ul>
10	Ripple Filter OUT 2.7 V <ul style="list-style-type: none"> <li>Ripple rejection ratio: <math>R_r</math> is 38 dB when <math>C_7 = 22</math> <math>\mu</math>F; 30 dB when <math>C_7 = 2.2</math> <math>\mu</math>F.</li> <li>Outflow current <math>I_7</math> max = 1 mA</li> </ul>
11	$V_{CC}$ 3.0 V
12	POWER GND
13	COMMON 1.2 V
14	POWER OUT1 1.2 V <ul style="list-style-type: none"> <li>CH1 output.</li> </ul>
15	POWER OUT2 1.2 V <ul style="list-style-type: none"> <li>CH2 output</li> </ul>
16	POWER MUTE 0.7 V ( $C_{10} = 1.0$ $\mu$ F to 4.7 $\mu$ F) <ul style="list-style-type: none"> <li>When connected to GND: POWER MUTE ON.</li> <li>MUTE ON conditions: <math>V_{16} \leq 0.3</math> V, outflow current <math>I_{16} \doteq 2.5</math> <math>\mu</math>A.</li> <li><math>C_{10}</math> can be used to control MUTE TIME.</li> <li>When <math>C_{10} = 2.2</math> <math>\mu</math>F, <math>V_{CC} = 3.0</math> V 0.7 sec.</li> </ul>
17	FWD/REV SW ( $C_{11} \leq 0.47$ $\mu$ F) <ul style="list-style-type: none"> <li>When connected to GND, PRE IN1R (pin 2) and IN2R (pin 23) turn on.</li> <li>When floating, PRE IN1F (pin 3) and IN2F (pin 22) turn on.</li> <li><math>C_{11}</math> and <math>R_7</math> are intended for smoothing at the time of switching.</li> <li>REV condition: <math>V_{17} \leq 0.2</math> V.</li> </ul>
18	POWER IN2 1.8 V <ul style="list-style-type: none"> <li>Input resistance <math>R_{IN} \doteq 30</math> k<math>\Omega</math></li> </ul>
19	SW OUT2 1.8 V <ul style="list-style-type: none"> <li>Provides PRE AMP2 when pin 8 is floating (PRE MUTE OFF) (equivalent to pin 20).</li> <li>Disconnects from PRE AMP2 and <math>R_{IN} \geq 500</math> k<math>\Omega</math> when pin 8 is <math>V_{CC}</math> (PRE MUTE ON).</li> </ul>
20	PRE OUT2 1.8 V <ul style="list-style-type: none"> <li>Like pin 19, 10 k<math>\Omega</math> load drivable.</li> </ul>
21	PRE NF2 1.8V
22	PRE IN2F 1.8 V <ul style="list-style-type: none"> <li>Turns on when pin 17 is floating.</li> <li>A bias resistor (2.2 k<math>\Omega</math>) must be connected between pin 22 and pin 24 (<math>V_{ref}</math>) when no head is in use.</li> </ul>
23	PRE IN2R 1.8 V <ul style="list-style-type: none"> <li>Turns on when pin 17 is connected to GND.</li> <li>A bias resistor (2.2 k<math>\Omega</math>) must be connected between pin 23 and pin 24 (<math>V_{ref}</math>) when no head is in use.</li> </ul>
24	$V_{ref}$ 1.8 V <ul style="list-style-type: none"> <li>The reference voltage is set to <math>3/5 \times V_{CC}</math>. Because <math>V_{ref}</math> AMP (<math>r_O \doteq 10</math> <math>\Omega</math>) is built in, <math>C_{17}</math> can be made smaller (1 <math>\mu</math>F).</li> <li>Inflow/outflow current <math>I_{24} = \pm 500</math> <math>\mu</math>A available.</li> </ul>

## Sample Application:

Radio set application.

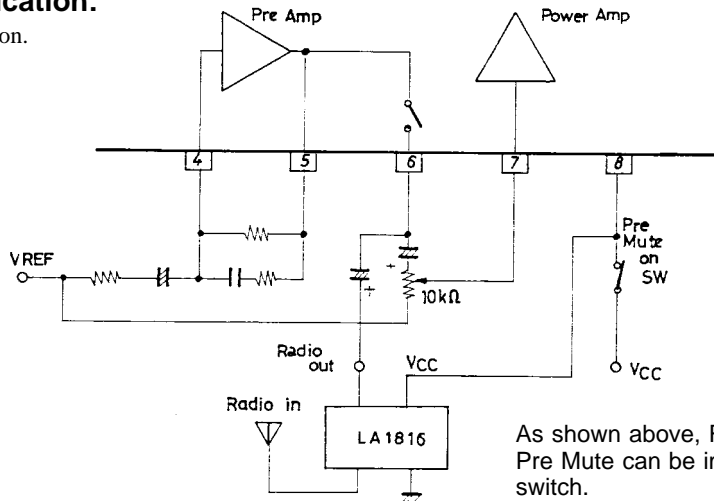

As shown above, Radio on and Pre Mute can be implemented with one-circuit switch.

IC Usage Notes

- The power amplifier outputs and the common amplifier output are connected through resistors of about 60 Ω. The resistors are for common amplifier oscillation blocking.

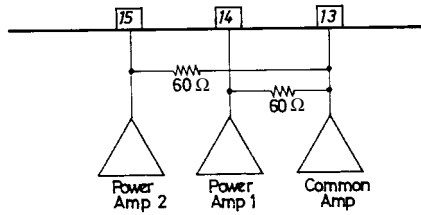

- The preamplifier muting function isolates the preamplifier outputs from SW OUT. The preamplifier is on even when the preamplifier muting is on.
- If transient noise is noticeable when the power supply is turned off, add the external circuit described below. Transient noise when the power is turned off can be improved by rapidly applying the power amplifier muting.

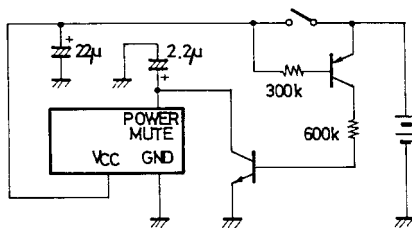

Unit (resistance: Ω, capacitance: F)

However, the standby current  $I_{ST}$  flows even when the power switch is off  
 $I_{ST} = (V_{CC} - V_{BE})/600 \text{ k}\Omega$   
 When  $V_{CC} = 3.0 \text{ V}$   
 $I_{ST} = (3.0 - 0.6)/600 \text{ k}\Omega \approx 4 \mu\text{A}$

- Internal equivalent circuit for each SW pin.

• Pre-mute

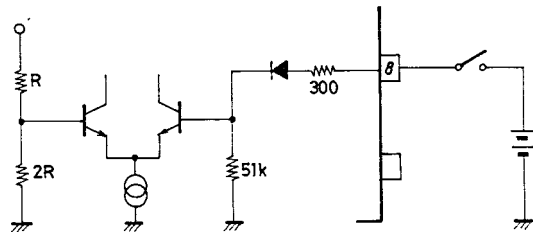

Unit (resistance: Ω)

MUTE ON condition :  $V_{8IN} \geq V_{CC} - 0.2 \text{ V}$   
 Inflow current :  $I_8 \approx 60 \mu\text{A}$  (when  $V_{CC} = 3.0 \text{ V}$ )

• Power mute

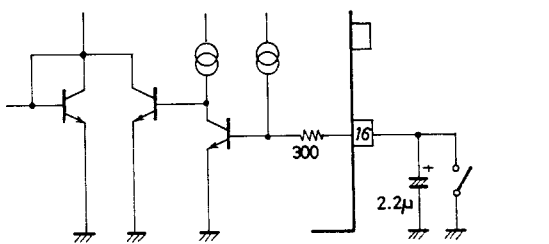

Unit (resistance: Ω, capacitance: F)

MUTE ON condition :  $V_{16} \leq 0.3 \text{ V}$   
 Outflow current :  $I_{16} \approx 2.5 \mu\text{A}$

• F/R SW

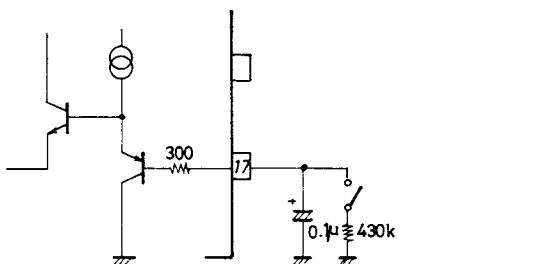

Unit (resistance: Ω, capacitance: F)

REV condition :  $V_{17} \leq 0.2 \text{ V}$

# LA4581MB

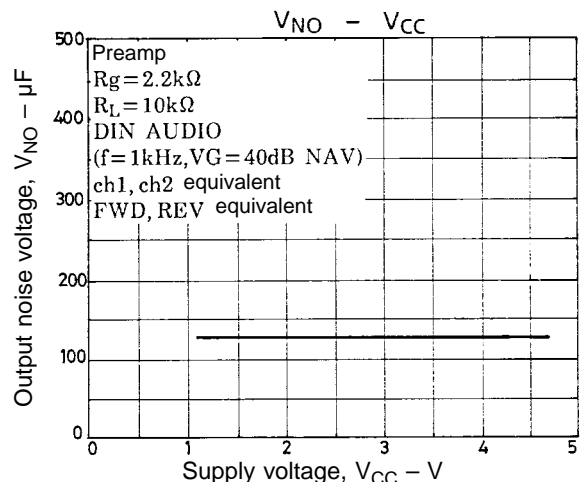
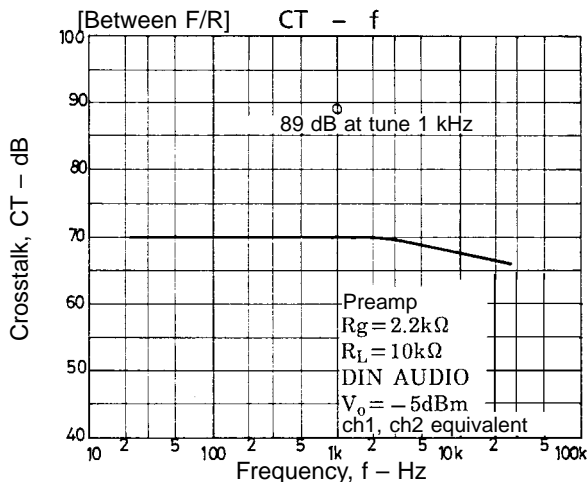
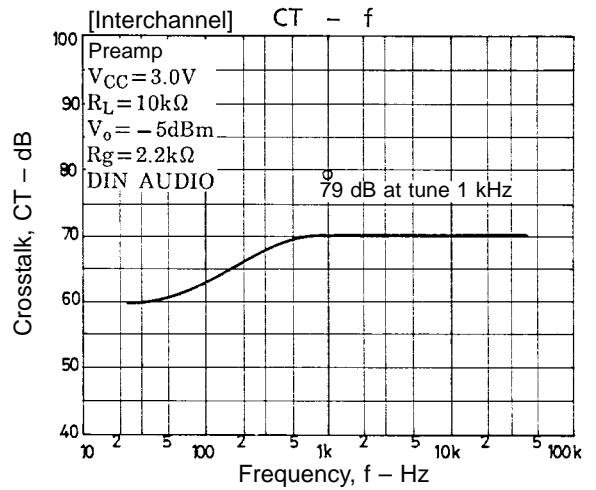
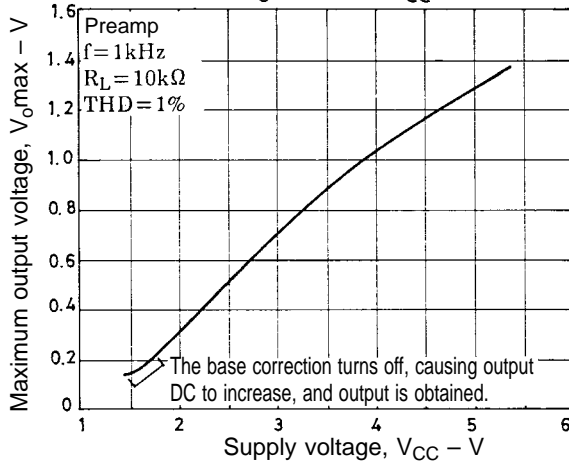
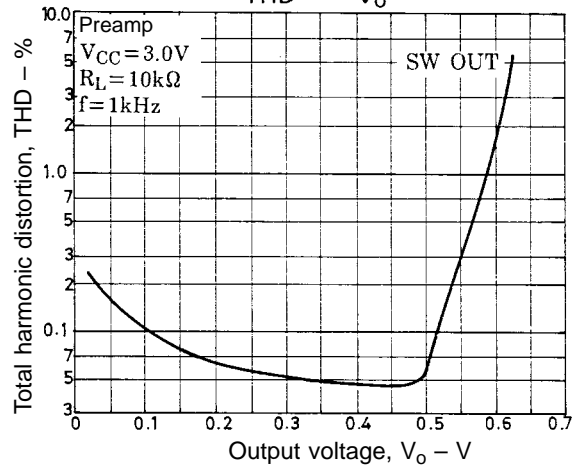
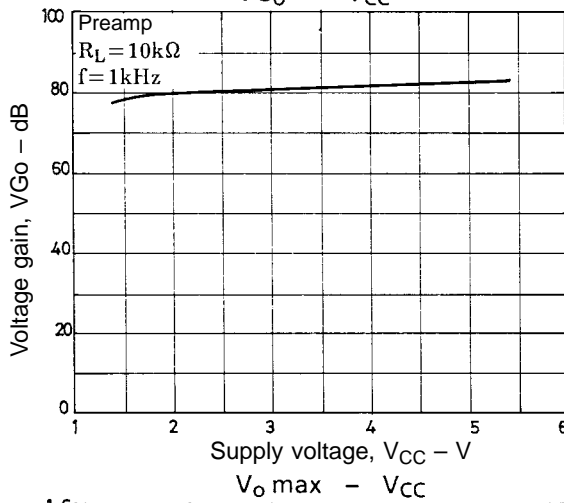
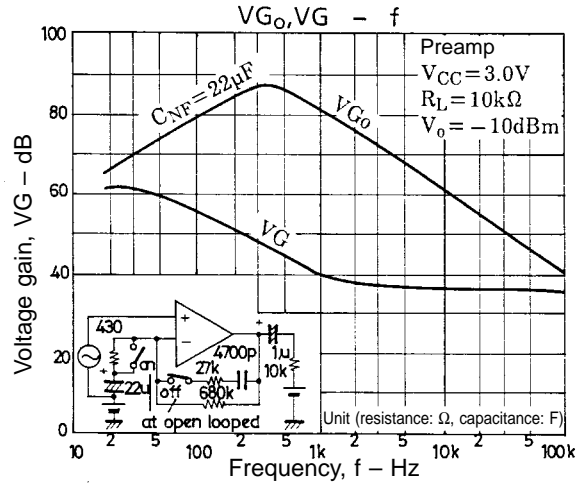
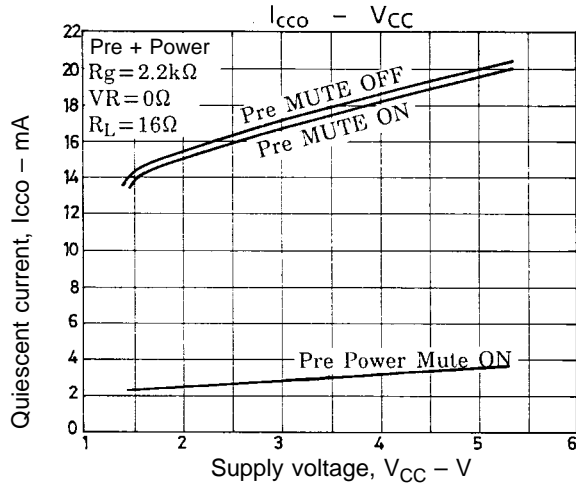

# LA4581MB

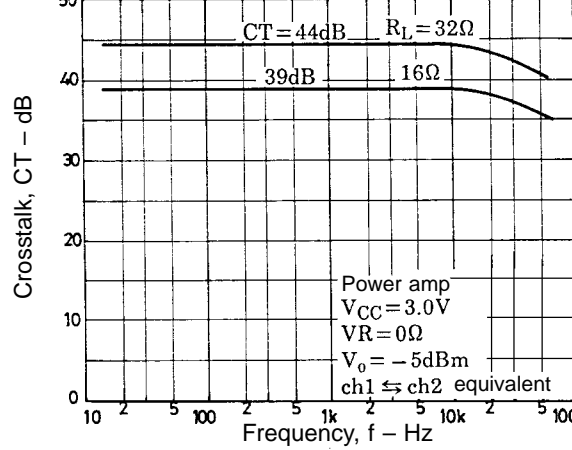
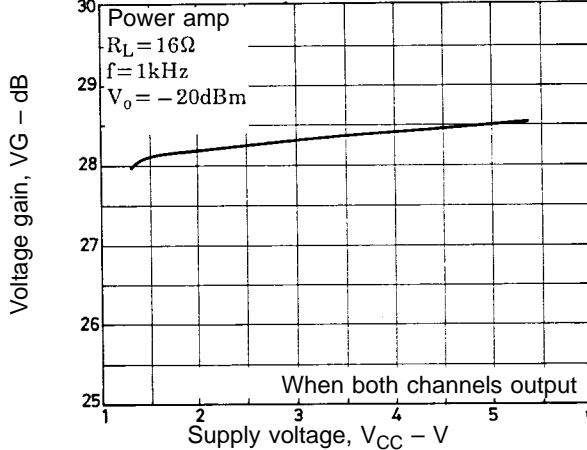
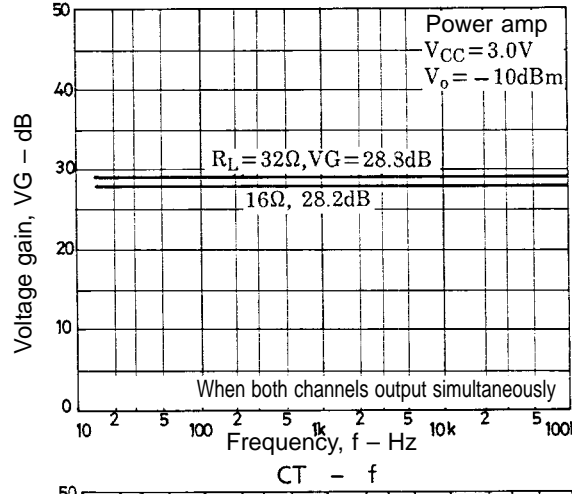
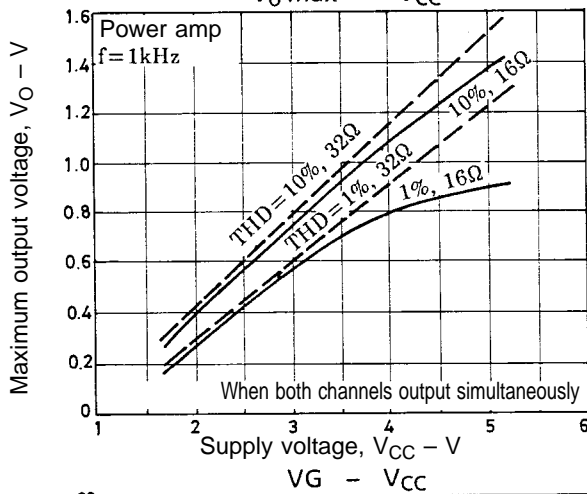
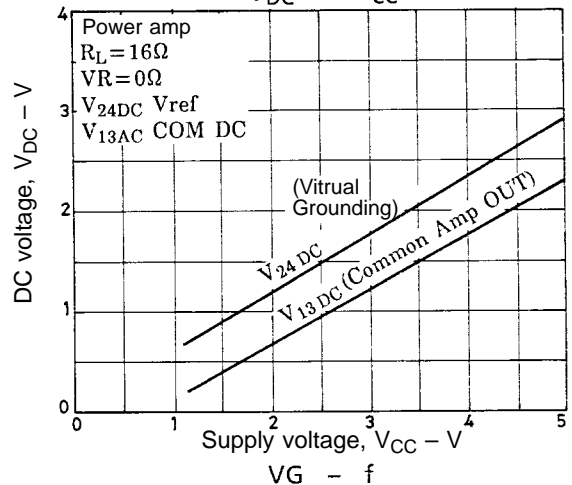
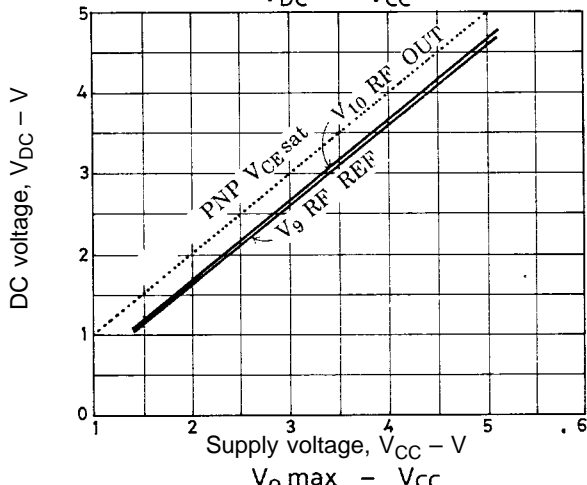
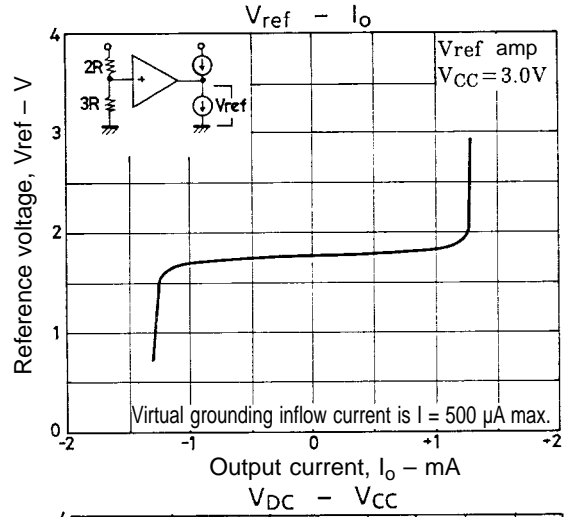
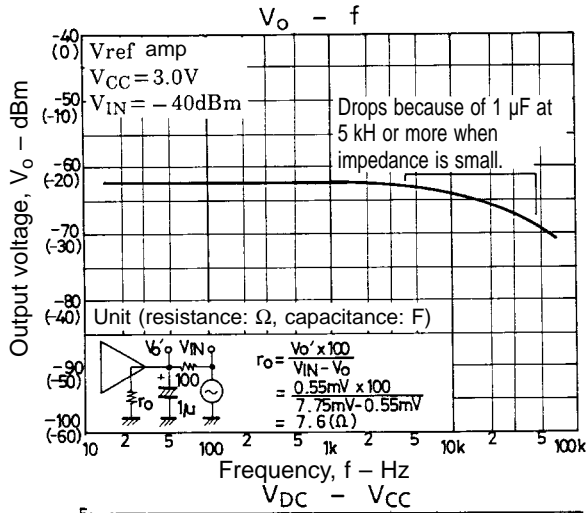

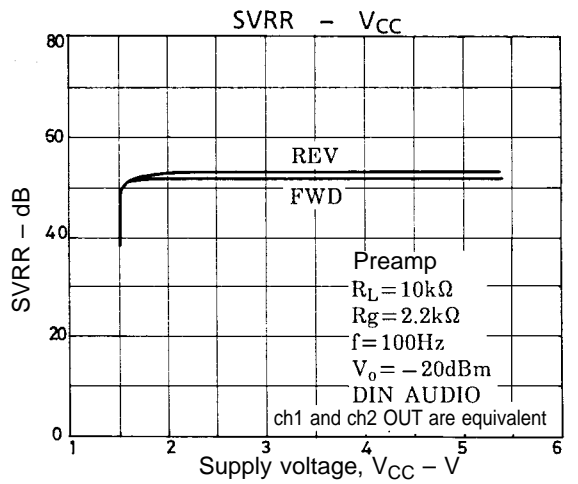
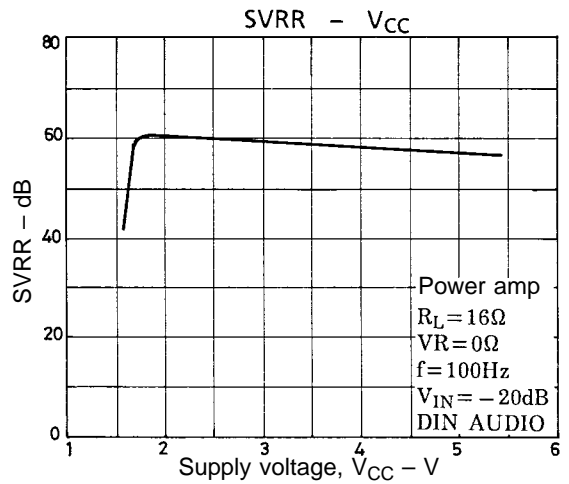
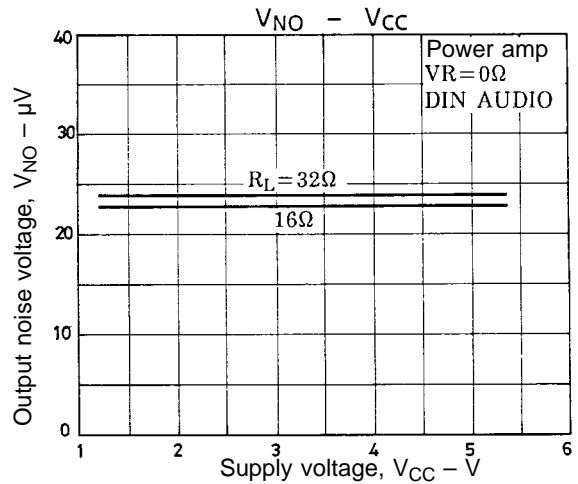
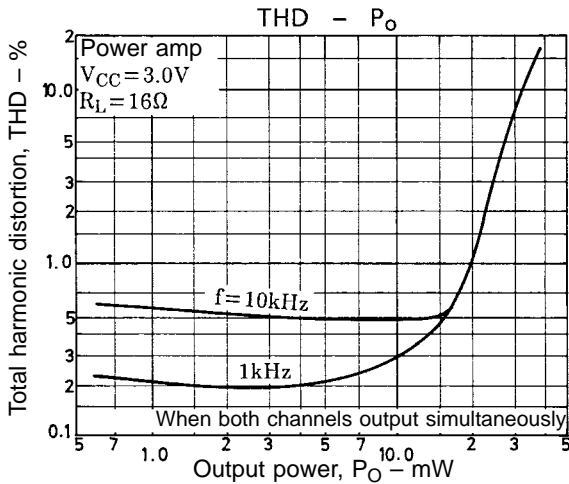
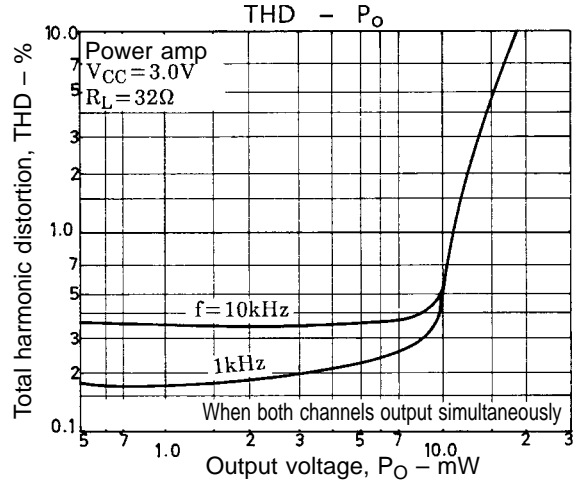
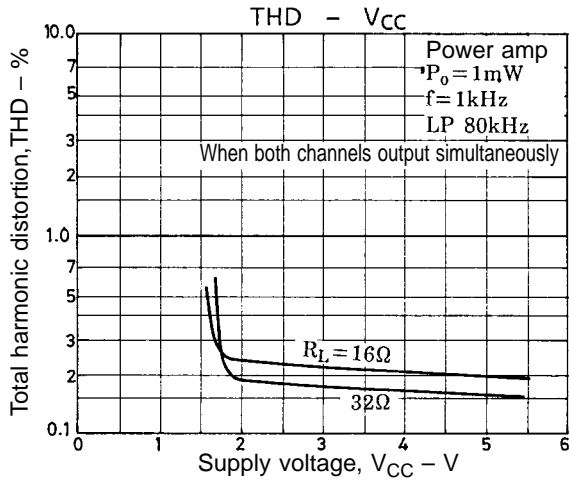

■ No products described or contained herein are intended for use in surgical implants, life-support systems, aerospace equipment, nuclear power control systems, vehicles, disaster/crime-prevention equipment and the like, the failure of which may directly or indirectly cause injury, death or property loss.

■ Anyone purchasing any products described or contained herein for an above-mentioned use shall:

- ① Accept full responsibility and indemnify and defend SANYO ELECTRIC CO., LTD., its affiliates, subsidiaries and distributors and all their officers and employees, jointly and severally, against any and all claims and litigation and all damages, cost and expenses associated with such use:
- ② Not impose any responsibility for any fault or negligence which may be cited in any such claim or litigation on SANYO ELECTRIC CO., LTD., its affiliates, subsidiaries and distributors or any of their officers and employees jointly or severally.

■ Information (including circuit diagrams and circuit parameters) herein is for example only; it is not guaranteed for volume production. SANYO believes information herein is accurate and reliable, but no guarantees are made or implied regarding its use or any infringements of intellectual property rights or other rights of third parties.