

### Features

- Diffused Junction
- Low Forward Voltage Drop
- High Current Capability
- High Reliability
- High Surge Current Capability

### Mechanical Data

- Case: Molded Plastic
- Terminals: Plated Leads Solderable per MIL-STD-202, Method 208
- Polarity: Cathode Band
- Weight: 1.2 grams (approx.)
- Mounting Position: Any
- Marking: Type Number
- Epoxy: UL 94V-O rate flame retardant

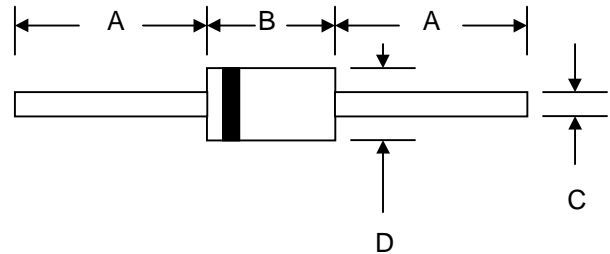

DO-201AD		
Dim	Min	Max
A	25.4	—
B	8.50	9.50
C	1.20	1.30
D	5.0	5.60
All Dimensions in mm		

### Maximum Ratings and Electrical Characteristics @ $T_A=25^\circ\text{C}$ unless otherwise specified

Single Phase, half wave, 60Hz, resistive or inductive load.  
For capacitive load, derate current by 20%.

Characteristic	Symbol	FR301	FR302	FR303	FR304	FR305	FR306	FR307	Unit
Peak Repetitive Reverse Voltage	$V_{RRM}$								V
Working Peak Reverse Voltage	$V_{RWM}$	50	100	200	400	600	800	1000	
DC Blocking Voltage	$V_R$								
RMS Reverse Voltage	$V_{R(RMS)}$	35	70	140	280	420	560	700	V
Average Rectified Output Current (Note 1) @ $T_A = 55^\circ\text{C}$	$I_o$	3.0							A
Non-Repetitive Peak Forward Surge Current 8.3ms Single half sine-wave superimposed on rated load (JEDEC Method)	$I_{FSM}$	150							A
Forward Voltage @ $I_F = 3.0\text{A}$	$V_{FM}$	1.2							V
Peak Reverse Current @ $T_A = 25^\circ\text{C}$ At Rated DC Blocking Voltage @ $T_A = 100^\circ\text{C}$	$I_{RM}$	10 150							$\mu\text{A}$
Reverse Recovery Time (Note 2)	$t_{rr}$	150				250	500		nS
Typical Junction Capacitance (Note 3)	$C_j$	60							pF
Operating Temperature Range	$T_j$	-65 to +125							$^\circ\text{C}$
Storage Temperature Range	$T_{STG}$	-65 to +150							$^\circ\text{C}$

**\*Glass passivated forms are available upon request**

Note: 1. Leads maintained at ambient temperature at a distance of 9.5mm from the case

2. Measured with  $I_F = 0.5\text{A}$ ,  $I_R = 1.0\text{A}$ ,  $IRR = 0.25\text{A}$ . See figure 5.

3. Measured at 1.0 MHz and applied reverse voltage of 4.0V D.C.

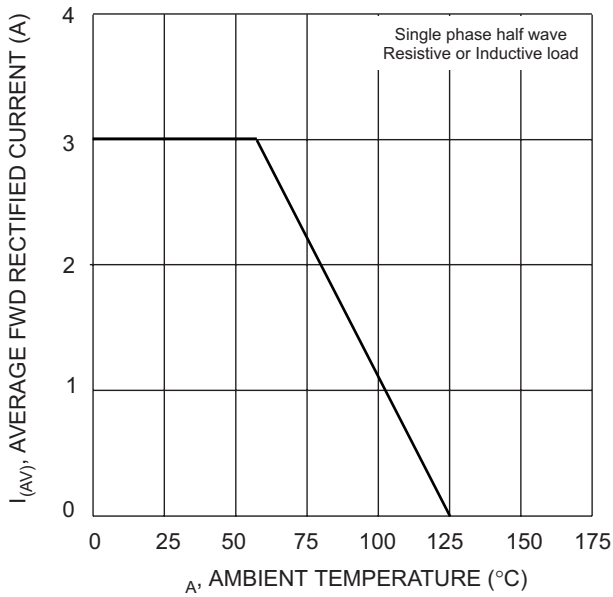

Fig. 1 Forward Derating Curve

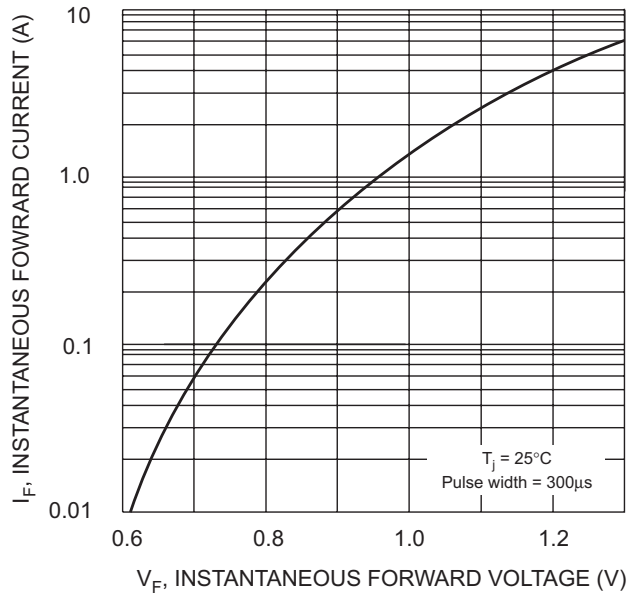

Fig. 2 Typical Forward Characteristics

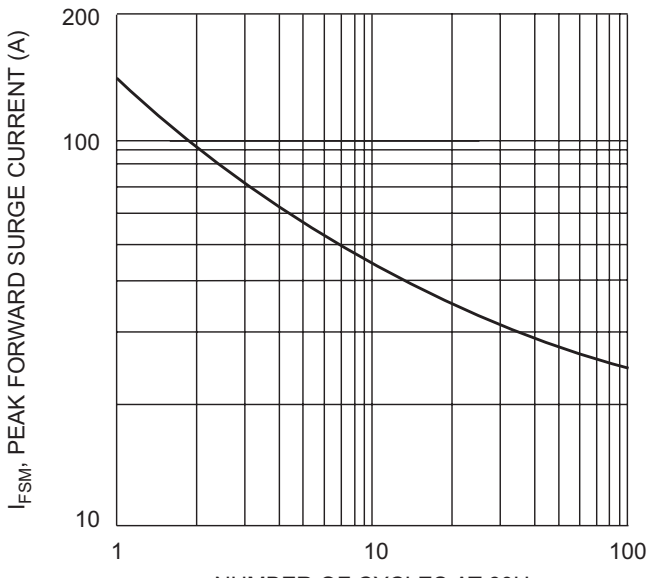

Fig. 3 Peak Forward Surge Current

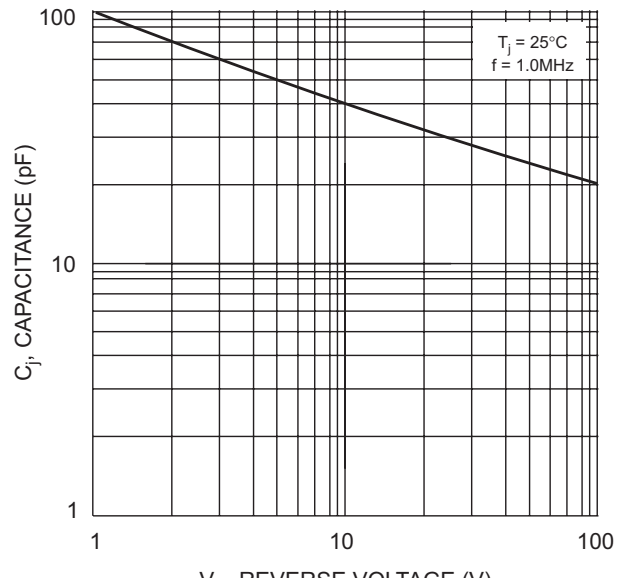
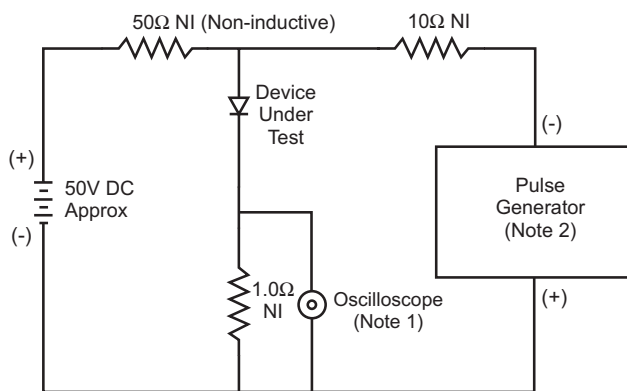

Fig. 4 Typical Junction Capacitance



- Notes:
1. Rise Time = 7.0ns max. Input Impedance = 1.0MΩ, 22pF.
  2. Rise Time = 10ns max. Input Impedance = 50Ω.

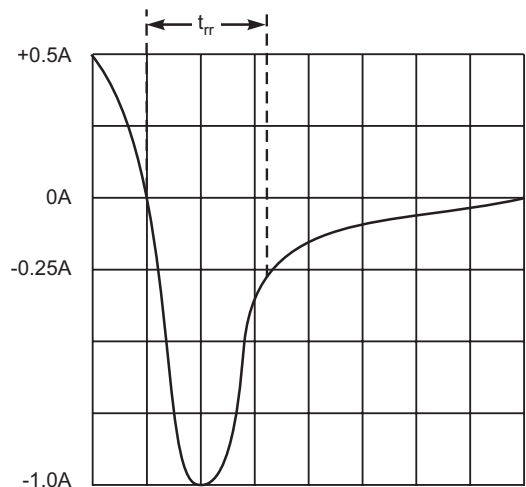

Fig. 5 Reverse Recovery Time Characteristic and Test Circuit

## ORDERING INFORMATION

Product No.◆	Package Type	Shipping Quantity
FR301-T3	DO-201AD	1200/Tape & Reel
<b>FR301-TB</b>	DO-201AD	1200/Tape & Box
FR301	DO-201AD	500 Units/Box
FR302-T3	DO-201AD	1200/Tape & Reel
<b>FR302-TB</b>	DO-201AD	1200/Tape & Box
FR302	DO-201AD	500 Units/Box
FR303-T3	DO-201AD	1200/Tape & Reel
<b>FR303-TB</b>	DO-201AD	1200/Tape & Box
FR303	DO-201AD	500 Units/Box
FR304-T3	DO-201AD	1200/Tape & Reel
<b>FR304-TB</b>	DO-201AD	1200/Tape & Box
FR304	DO-201AD	500 Units/Box
FR305-T3	DO-201AD	1200/Tape & Reel
<b>FR305-TB</b>	DO-201AD	1200/Tape & Box
FR305	DO-201AD	500 Units/Box
FR306-T3	DO-201AD	1200/Tape & Reel
<b>FR306-TB</b>	DO-201AD	1200/Tape & Box
FR306	DO-201AD	500 Units/Box
FR307-T3	DO-201AD	1200/Tape & Reel
<b>FR307-TB</b>	DO-201AD	1200/Tape & Box
FR307	DO-201AD	500 Units/Box

Products listed in **bold** are WTE **Preferred** devices.

◆T3 suffix refers to a 13" reel. TB suffix refers to Ammo Pack.

Shipping quantity given is for minimum packing quantity only. For minimum order quantity, please consult the Sales Department.

Won-Top Electronics Co., Ltd (WTE) has checked all information carefully and believes it to be correct and accurate. However, WTE cannot assume any responsibility for inaccuracies. Furthermore, this information does not give the purchaser of semiconductor devices any license under patent rights to manufacturer. WTE reserves the right to change any or all information herein without further notice.

**WARNING:** DO NOT USE IN LIFE SUPPORT EQUIPMENT. WTE power semiconductor products are not authorized for use as critical components in life support devices or systems without the express written approval.

**Won-Top Electronics Co., Ltd.**

No. 44 Yu Kang North 3rd Road, Chine Chen Dist., Kaohsiung, Taiwan

**Phone:** 886-7-822-5408 or 886-7-822-5410

**Fax:** 886-7-822-5417

**Email:** sales@wontop.com

**Internet:** http://www.wontop.com

*We power your everyday.*