

Built-in Avalanche Diode for Surge Absorbing Darlington

2SD2141

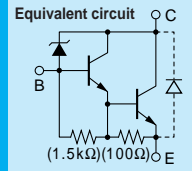

Silicon NPN Triple Diffused Planar Transistor

Application : Ignitor, Driver for Solenoid and Motor, and General Purpose

Absolute maximum ratings (Ta=25°C)

Symbol	2SD2141	Unit
V _{CB0}	380±50	V
V _{CE0}	380±50	V
V _{EB0}	6	V
I _C	6(Pulse10)	A
I _B	1	A
P _C	35(T _C =25°C)	W
T _J	150	°C
T _{stg}	-55 to +150	°C

Electrical Characteristics (Ta=25°C)

Symbol	Conditions	2SD2141	Unit
I _{CB0}	V _{CB} =330V	10max	μA
I _{EB0}	V _{EB} =6V	20max	mA
V(BR) _{CEO}	I _C =25mA	330 to 430	V
h _{FE}	V _{CE} =2V, I _C =3A	1500min	
V _{CE(sat)}	I _C =4A, I _B =20mA	1.5max	V
f _r	V _{CE} =12V, I _E =-0.5A	20typ	MHz
COB	V _{CB} =10V, f=1MHz	95typ	pF

External Dimensions FM20(TO220F)

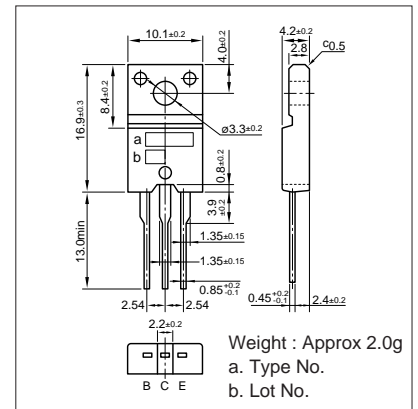

I_C-V_{CE} Characteristics (Typical)

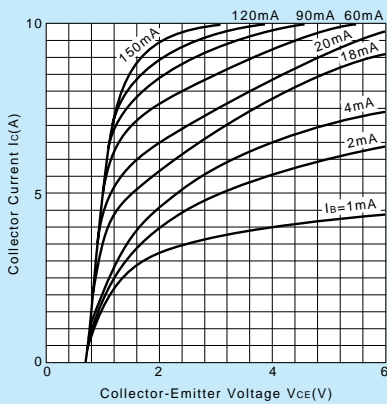

V_{CE(sat)}-I_B Characteristics (Typical)

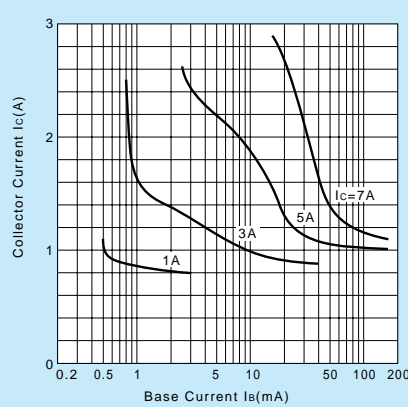

I_C-V_{BE} Temperature Characteristics (Typical)

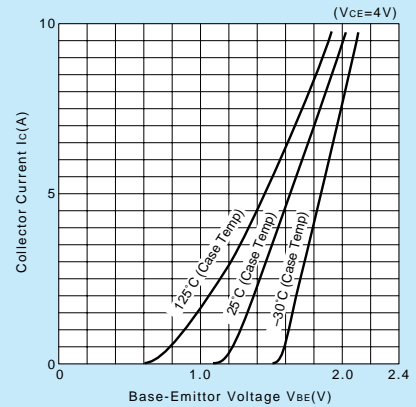

h_{FE}-I_C Characteristics (Typical)

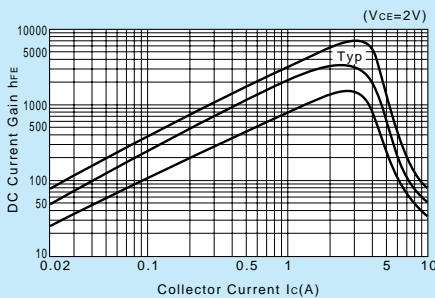

h_{FE}-I_C Temperature Characteristics (Typical)

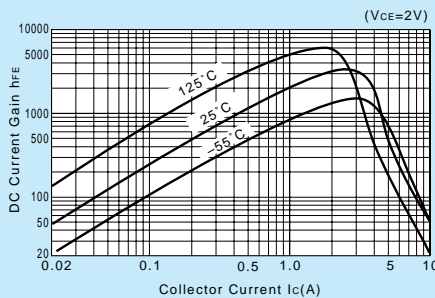

θ_{j-a}-t Characteristics

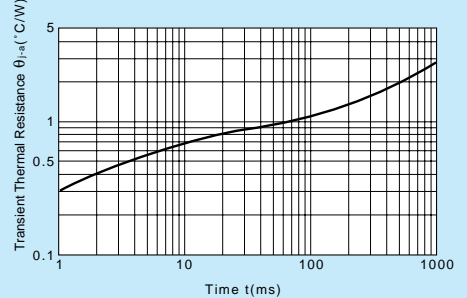

f_r-I_E Characteristics (Typical)

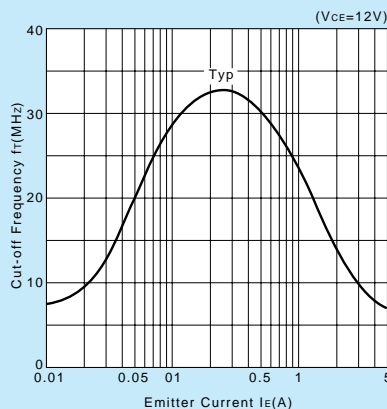

Safe Operating Area (Single Pulse)

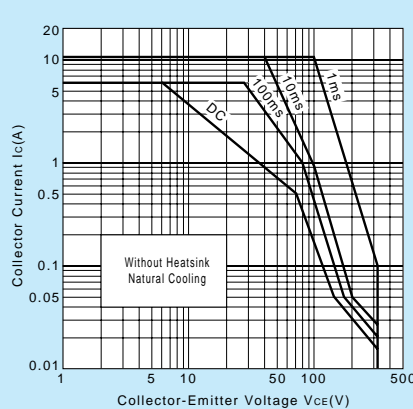

P_C-T_a Derating

