

# IRF7705

HEXFET® Power MOSFET

- Ultra Low On-Resistance
- P-Channel MOSFET
- Very Small SOIC Package
- Low Profile (< 1.2mm)
- Available in Tape & Reel

$V_{DS}$	$R_{DS(on)}$ max (m $\Omega$ )	$I_D$
<b>-30V</b>	18 @ $V_{GS} = -10V$	-8.0A
	30 @ $V_{GS} = -4.5V$	-6.0A

## Description

HEXFET® power MOSFETs from International Rectifier utilize advanced processing techniques to achieve extremely low on-resistance per silicon area. This benefit, combined with the ruggedized device design, that International Rectifier is well known for, provides the designer with an extremely efficient and reliable device for use in battery and load management.

The TSSOP-8 package has 45% less footprint area than the standard SO-8. This makes the TSSOP-8 an ideal device for applications where printed circuit board space is at a premium. The low profile (<1.2mm) allows it to fit easily into extremely thin environments such as portable electronics and PCMCIA cards.

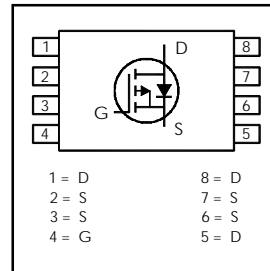

## Absolute Maximum Ratings

	Parameter	Max.	Units
$V_{DS}$	Drain- Source Voltage	-30	V
$I_D$ @ $T_C = 25^\circ C$	Continuous Drain Current, $V_{GS} @ -10V$	-8.0	A
$I_D$ @ $T_C = 70^\circ C$	Continuous Drain Current, $V_{GS} @ -10V$	-6.0	
$I_{DM}$	Pulsed Drain Current ①	-30	
$P_D$ @ $T_C = 25^\circ C$	Power Dissipation ③	1.5	W
$P_D$ @ $T_C = 70^\circ C$	Power Dissipation ③	0.96	
	Linear Derating Factor	0.012	W/°C
$V_{GS}$	Gate-to-Source Voltage	$\pm 20$	V
$T_J, T_{STG}$	Junction and Storage Temperature Range	-55 to + 150	°C

## Thermal Resistance

	Parameter	Max.	Units
$R_{\theta JA}$	Maximum Junction-to-Ambient ③	83	°C/W

## Electrical Characteristics @ $T_J = 25^\circ\text{C}$ (unless otherwise specified)

	Parameter	Min.	Typ.	Max.	Units	Conditions
$V_{(BR)DSS}$	Drain-to-Source Breakdown Voltage	-30	—	—	V	$V_{GS} = 0V, I_D = -250\mu A$
$\Delta V_{(BR)DSS}/\Delta T_J$	Breakdown Voltage Temp. Coefficient	—	0.015	—	V/°C	Reference to $25^\circ\text{C}$ , $I_D = -1\text{mA}$
$R_{DS(on)}$	Static Drain-to-Source On-Resistance	—	—	18	m $\Omega$	$V_{GS} = -10V, I_D = -8.0A$ ②
		—	—	30		$V_{GS} = -4.5V, I_D = -6.0A$ ②
$V_{GS(th)}$	Gate Threshold Voltage	-1.0	—	-2.5	V	$V_{DS} = V_{GS}, I_D = -250\mu A$
$g_{fs}$	Forward Transconductance	13	—	—	S	$V_{DS} = -10V, I_D = -8.0A$
$I_{DSS}$	Drain-to-Source Leakage Current	—	—	-15	$\mu A$	$V_{DS} = -24V, V_{GS} = 0V$
		—	—	-25		$V_{DS} = -24V, V_{GS} = 0V, T_J = 70^\circ\text{C}$
$I_{GSS}$	Gate-to-Source Forward Leakage	—	—	-100	nA	$V_{GS} = -20V$
	Gate-to-Source Reverse Leakage	—	—	100		$V_{GS} = 20V$
$Q_g$	Total Gate Charge	—	58	88	nC	$I_D = -8.0A$
$Q_{gs}$	Gate-to-Source Charge	—	10	—		$V_{DS} = -15V$
$Q_{gd}$	Gate-to-Drain ("Miller") Charge	—	9.0	—		$V_{GS} = -10V$ ②
$t_{d(on)}$	Turn-On Delay Time	—	18	27	ns	$V_{DD} = -15V, V_{GS} = -10V$ ②
$t_r$	Rise Time	—	35	53		$I_D = -1.0A$
$t_{d(off)}$	Turn-Off Delay Time	—	270	405		$R_D = 15\Omega$
$t_f$	Fall Time	—	128	190		$R_G = 6.0\Omega$ ②
$C_{iss}$	Input Capacitance	—	2774	—	pF	$V_{GS} = 0V$
$C_{oss}$	Output Capacitance	—	418	—		$V_{DS} = -25V$
$C_{rss}$	Reverse Transfer Capacitance	—	270	—		$f = 1.0\text{MHz}$

## Source-Drain Ratings and Characteristics

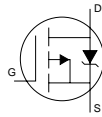
	Parameter	Min.	Typ.	Max.	Units	Conditions
$I_S$	Continuous Source Current (Body Diode)	—	—	-1.5	A	MOSFET symbol showing the integral reverse p-n junction diode. 
$I_{SM}$	Pulsed Source Current (Body Diode) ①	—	—	-30		
$V_{SD}$	Diode Forward Voltage	—	—	-1.2	V	$T_J = 25^\circ\text{C}, I_S = -1.5A, V_{GS} = 0V$ ②
$t_{rr}$	Reverse Recovery Time	—	36	54	ns	$T_J = 25^\circ\text{C}, I_F = -1.5A$
$Q_{rr}$	Reverse Recovery Charge	—	34	50	nC	$di/dt = 100A/\mu s$ ②

### Notes:

① Repetitive rating; pulse width limited by max. junction temperature.

② Pulse width  $\leq 400\mu s$ ; duty cycle  $\leq 2\%$ .

③ When mounted on 1 inch square copper board,  $t < 10$  sec

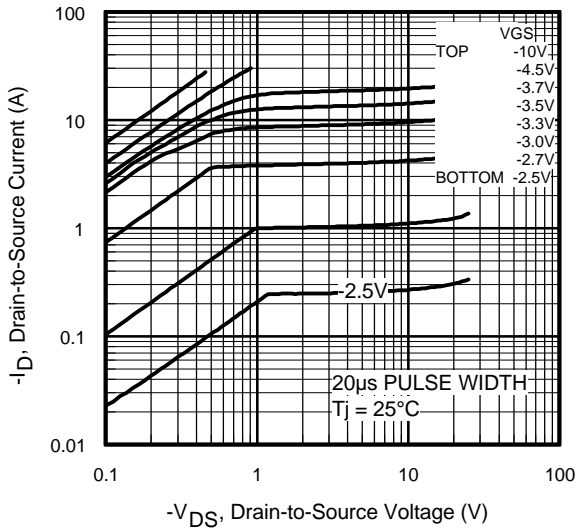

Fig 1. Typical Output Characteristics

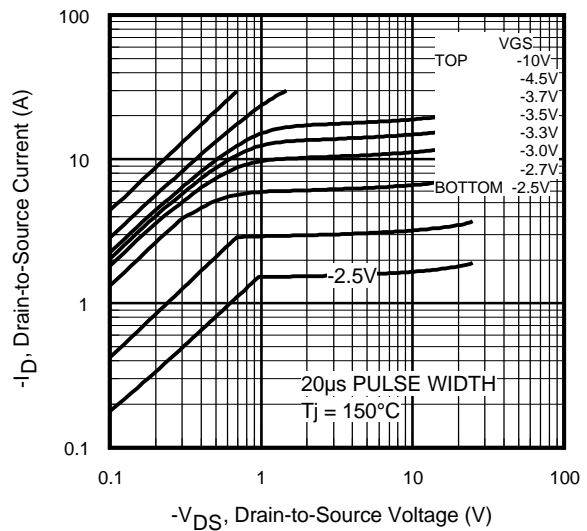

Fig 2. Typical Output Characteristics

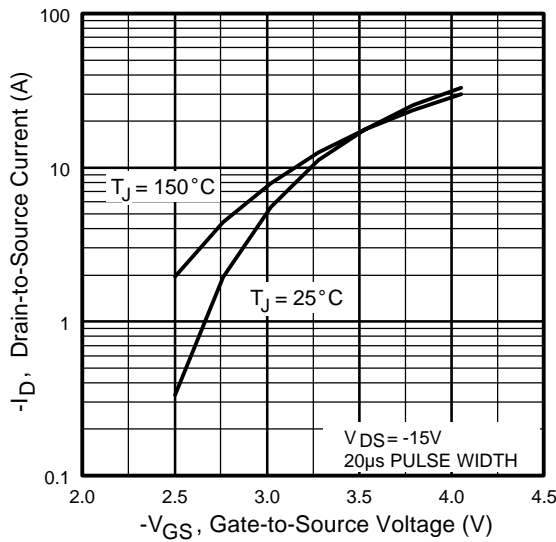

Fig 3. Typical Transfer Characteristics

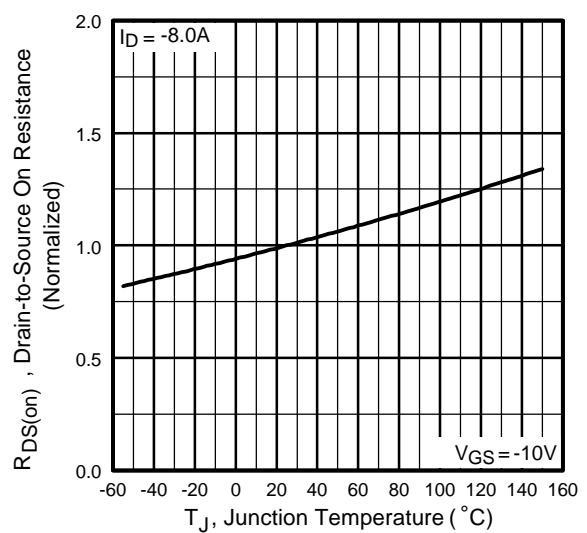
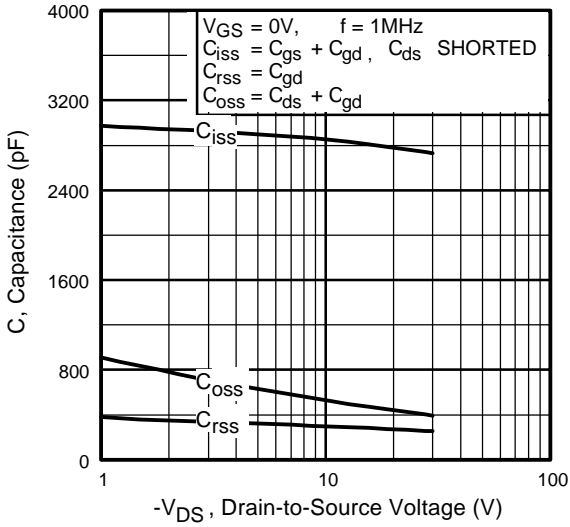
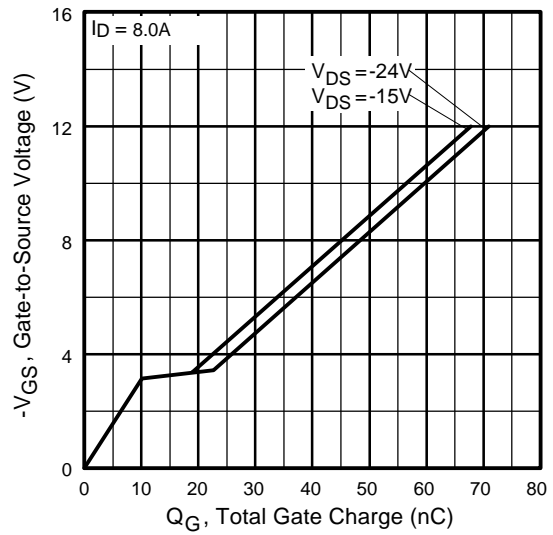

Fig 4. Normalized On-Resistance Vs. Temperature



**Fig 5.** Typical Capacitance Vs. Drain-to-Source Voltage



**Fig 6.** Typical Gate Charge Vs. Gate-to-Source Voltage

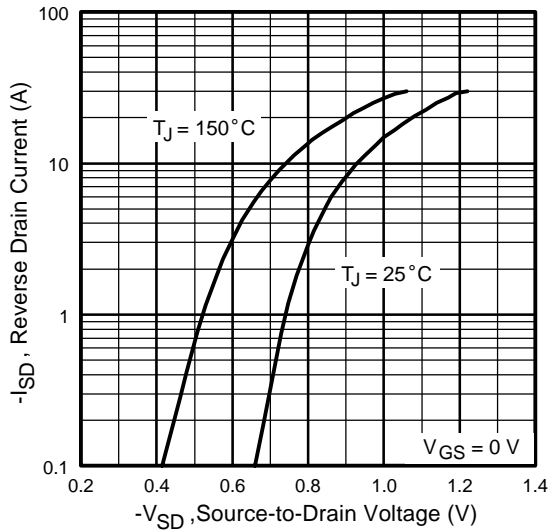

**Fig 7.** Typical Source-Drain Diode Forward Voltage

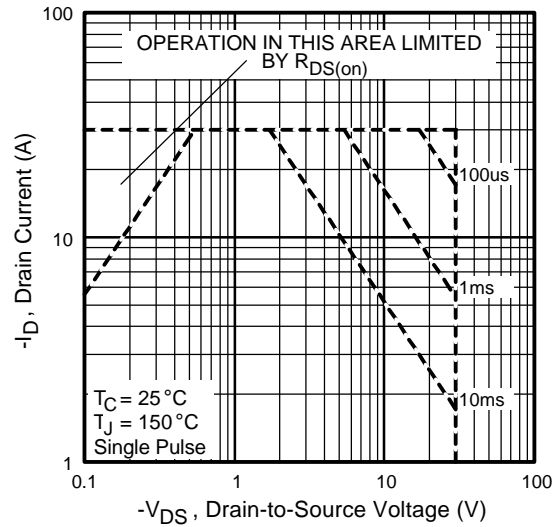

**Fig 8.** Maximum Safe Operating Area

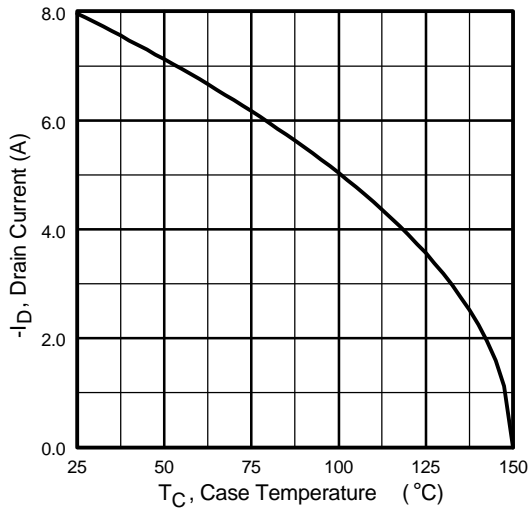

**Fig 9.** Maximum Drain Current Vs. Case Temperature

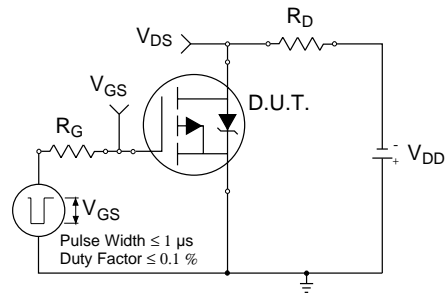

**Fig 10a.** Switching Time Test Circuit

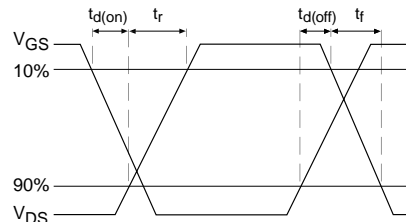

**Fig 10b.** Switching Time Waveforms

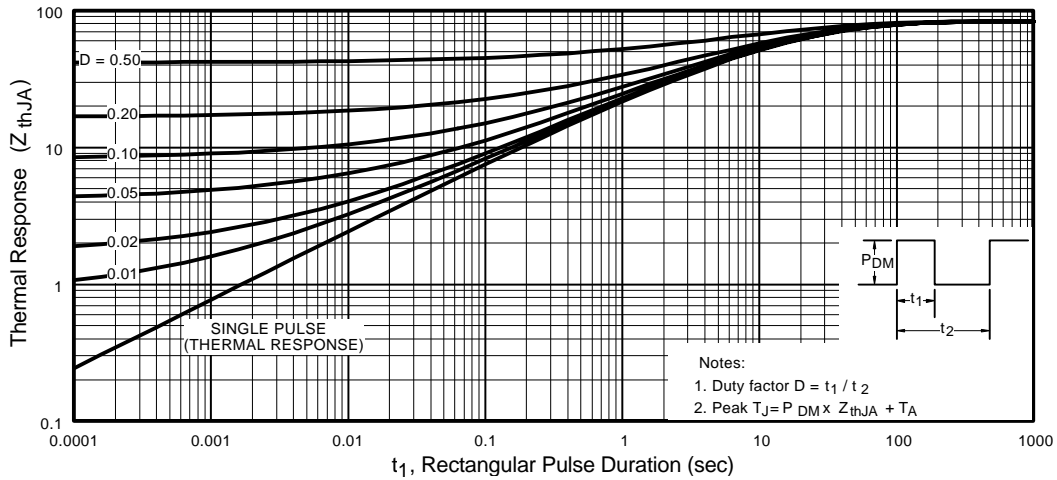

**Fig 11.** Maximum Effective Transient Thermal Impedance, Junction-to-Ambient

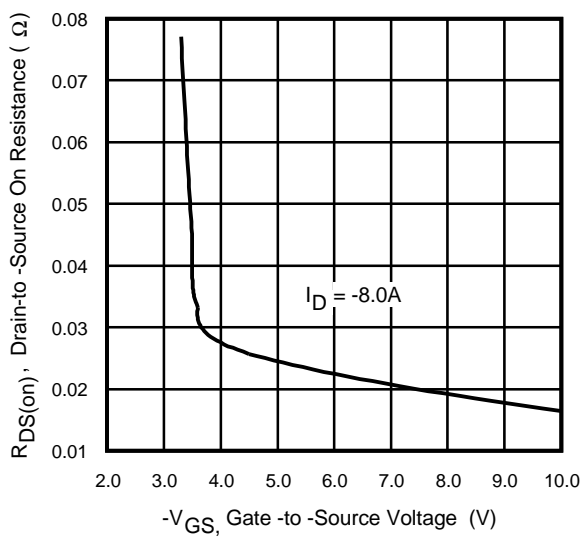

**Fig 12.** Typical On-Resistance Vs. Gate Voltage

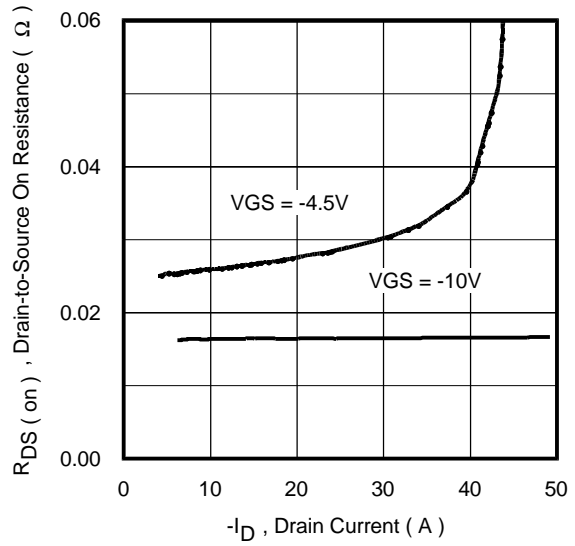

**Fig 13.** Typical On-Resistance Vs. Drain Current

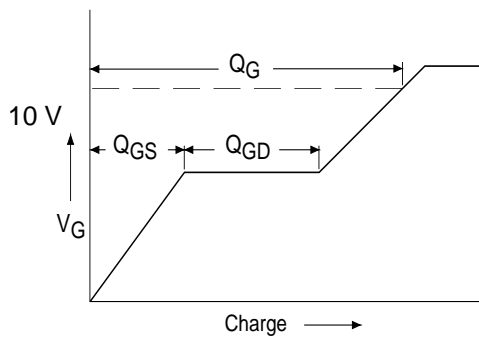

**Fig 14a.** Basic Gate Charge Waveform

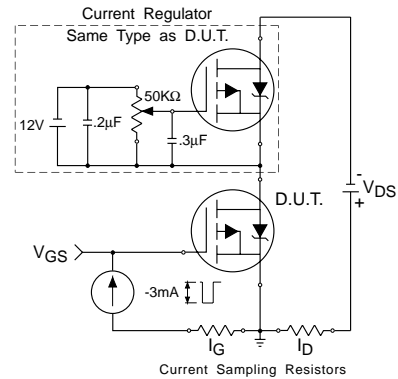

**Fig 14b.** Gate Charge Test Circuit

## TSSOP-8 Part Marking Information

EXAMPLE: THIS IS AN IRF7702

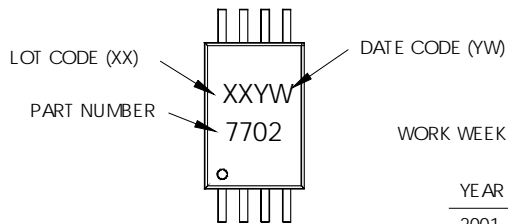

DATE CODE EXAMPLES:

9503 = 5C  
 9532 = EF

TABLE 1

WORK WEEK 1-26, NUMERIC YEAR CODE (1,2, ...ETC.)

YEAR	Y	WORK WEEK	W
2001	1	01	A
2002	2	02	B
2003	3	03	C
1994	4	04	D
1995	5		
1996	6		
1997	7		
1998	8		
1999	9		
2000	0	24	X
		25	Y
		26	Z

TABLE 2

WORK WEEK 27-52, ALPHANUMERIC YEAR CODE (A,B, ...ETC.)

YEAR	Y	WORK WEEK	W
2001	A	27	A
2002	B	28	B
2003	C	29	C
1994	D	30	D
1995	E		
1996	F		
1997	G		
1998	H		
1999	J		
2000	K	50	X
		51	Y
		52	Z

## TSSOP-8 Tape and Reel

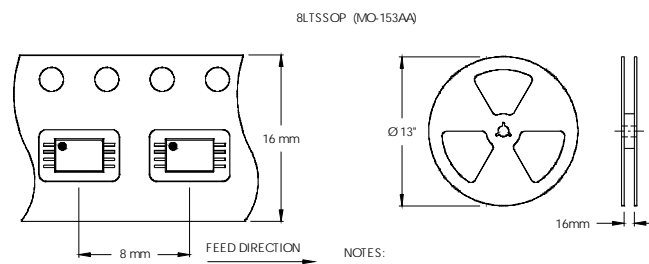

NOTES:  
 1. TAPE & REEL OUTLINE CONFORMS TO EIA-481 & EIA-541.

# IRF7705

International  
**IR** Rectifier

## TSSOP-8 Package Outline

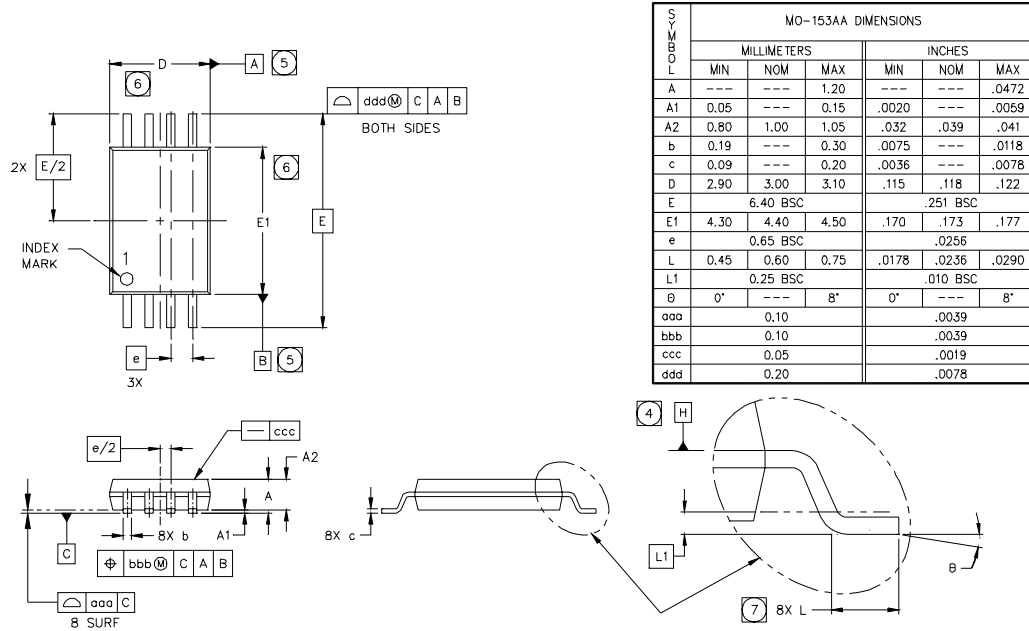

### NOTES

- DIMENSIONING AND TOLERANCING PER ASME Y14.5M-1994.
- DIMENSIONS ARE SHOWN IN MILLIMETERS AND INCHES.
- CONTROLLING DIMENSION: MILLIMETER.
- DATUM PLANE H IS LOCATED AS SHOWN.
- DATUM A AND B TO BE DETERMINED AT DATUM PLANE H.
- DIMENSIONS D AND E1 ARE MEASURED AT DATUM PLANE H.
- DIMENSION L IS THE LEAD LENGTH FOR SOLDERING TO A SUBSTRATE.
- OUTLINE CONFORMS TO JEDEC OUTLINE MO-153AA.

### LEAD ASSIGNMENTS

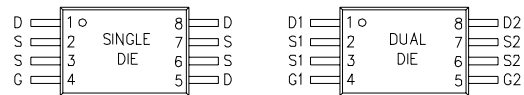

Data and specifications subject to change without notice.  
This product has been designed and qualified for the consumer market.  
Qualification Standards can be found on IR's Web site.

International  
**IR** Rectifier

IR WORLD HEADQUARTERS: 233 Kansas St., El Segundo, California 90245, USA Tel: (310) 252-7105  
TAC Fax: (310) 252-7903

Visit us at [www.irf.com](http://www.irf.com) for sales contact information.06/01