

N-CHANNEL MOS FIELD EFFECT TRANSISTOR
 FOR HIGH SPEED SWITCHING

DESCRIPTION

The μ PA675T is an N-channel vertical MOS FET. Because it can be driven by a voltage as low as 1.5 V and it is not necessary to consider a drive current, this FET is ideal as an actuator for low-current portable systems such as headphone stereos and video cameras.

FEATURES

- Two MOS FET circuits in package the same size as SC-70
- Automatic mounting supported
- Gate can be driven by a 1.5 V power source
- Because of its high input impedance, there's no need to consider a drive current
- Since bias resistance can be omitted, the number of components required can be reduced

PACKAGE DRAWING (Unit: mm)

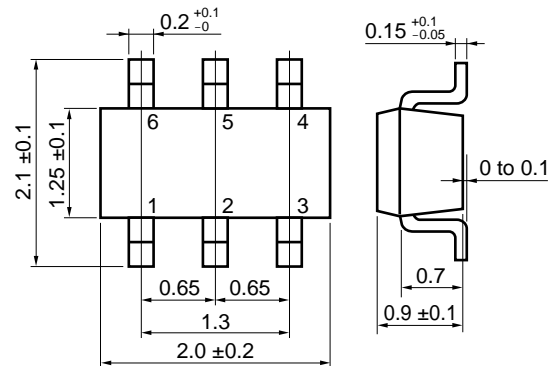

PIN CONNECTION

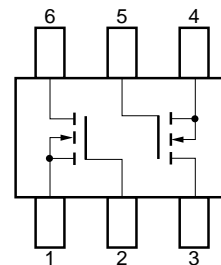

1. Source 1 (S1)
2. Gate 1 (G1)
3. Drain 2 (D2)
4. Source 2 (S2)
5. Gate 2 (G2)
6. Drain 1 (D1)

ORDERING INFORMATION

PART NUMBER	PACKAGE
μ PA675T ^{Note}	SC-88 (SSP)

Note Marking: SA

ABSOLUTE MAXIMUM RATINGS (T_A = 25°C)

Drain to Source Voltage (V _{GS} = 0 V)	V _{DSS}	16	V
Gate to Source Voltage (V _{DS} = 0 V)	V _{GSS}	±7.0	V
Drain Current (DC) (T _c = 25°C)	I _{D(DC)}	±0.1	A
Drain Current (pulse) ^{Note}	I _{D(pulse)}	±0.2	A
Total Power Dissipation (T _c = 25°C)	P _T	0.2	W
Channel Temperature	T _{ch}	150	°C
Storage Temperature	T _{stg}	-55 to +150	°C

Note PW ≤ 10 ms, Duty Cycle ≤ 50%

The information in this document is subject to change without notice. Before using this document, please confirm that this is the latest version.
 Not all devices/types available in every country. Please check with local NEC representative for availability and additional information.

ELECTRICAL CHARACTERISTICS (TA = 25°C)

CHARACTERISTICS	SYMBOL	TEST CONDITIONS	MIN.	TYP.	MAX.	UNIT
Zero Gate Voltage Drain Current	I_{DSS}	$V_{DS} = 16\text{ V}, V_{GS} = 0\text{ V}$			1.0	μA
Gate Leakage Current	I_{GSS}	$V_{GS} = \pm 7.0\text{ V}, V_{DS} = 0\text{ V}$			± 3.0	μA
Gate Cut-off Voltage	$V_{GS(off)}$	$V_{DS} = 3\text{ V}, I_D = 10\ \mu\text{A}$	0.5	0.8	1.1	V
Forward Transfer Admittance	$ y_{fs} $	$V_{DS} = 3\text{ V}, I_D = 10\text{ mA}$	20			mS
Drain to Source On-state Resistance	$R_{DS(on)1}$	$V_{GS} = 1.5\text{ V}, I_D = 1\text{ mA}$		20	50	Ω
	$R_{DS(on)2}$	$V_{GS} = 2.5\text{ V}, I_D = 10\text{ mA}$		7	15	Ω
	$R_{DS(on)3}$	$V_{GS} = 4.0\text{ V}, I_D = 10\text{ mA}$		5	12	Ω
Input Capacitance	C_{iss}	$V_{DS} = 3\text{ V}$		10		pF
Output Capacitance	C_{oss}	$V_{GS} = 0\text{ V}$		13		pF
Reverse Transfer Capacitance	C_{rss}	$f = 1\text{ MHz}$		3		pF
Turn-on Delay Time	$t_{d(on)}$	$V_{DD} = 3\text{ V}, I_D = 10\text{ mA}$		15		ns
Rise Time	t_r	$V_{GS} = 3\text{ V}$		70		ns
Turn-off Delay Time	$t_{d(off)}$	$R_G = 10\ \Omega$		100		ns
Fall Time	t_f			110		ns

SWITCHING TIME MEASUREMENT CIRCUIT AND CONDITIONS

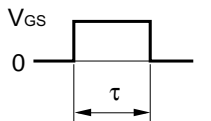
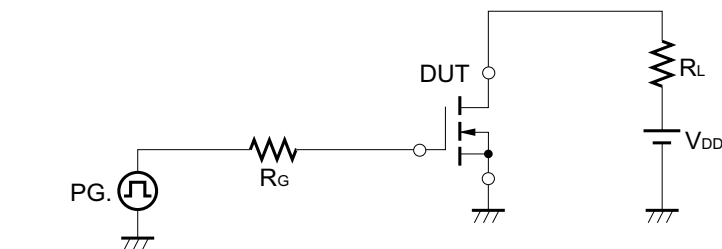

$\tau = 1\ \mu\text{s}$
Duty Cycle $\leq 1\%$

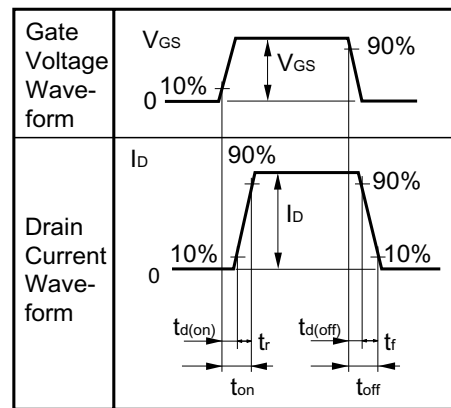

TYPICAL CHARACTERISTICS ($T_A = 25^\circ\text{C}$)

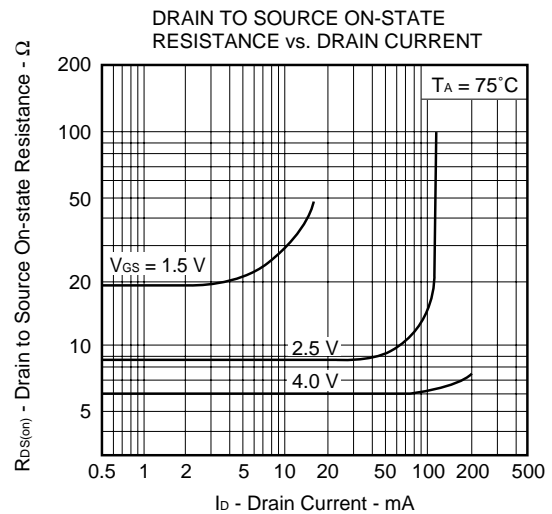
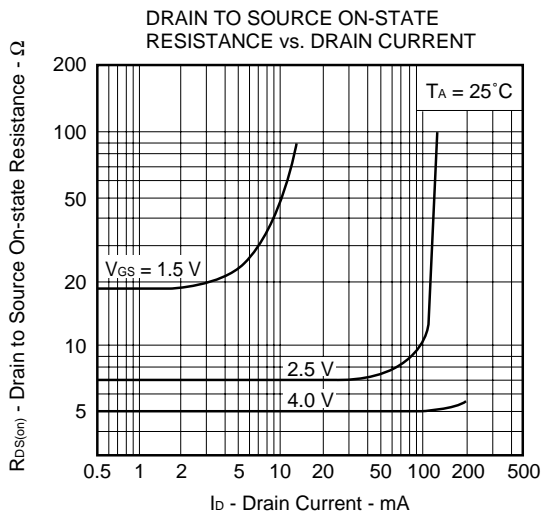
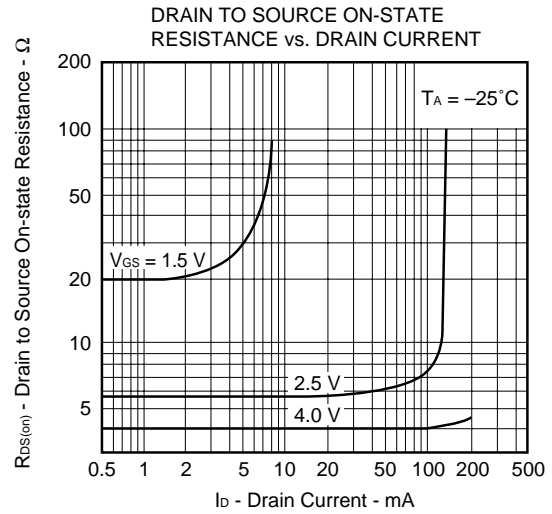
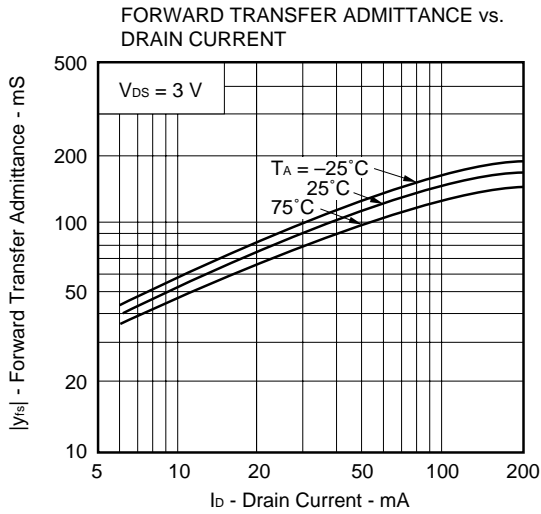
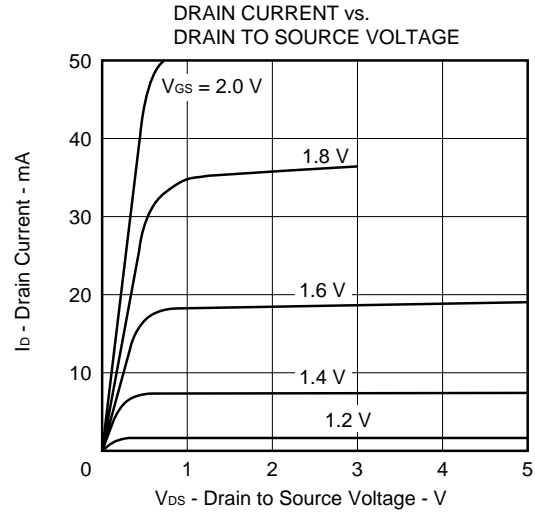
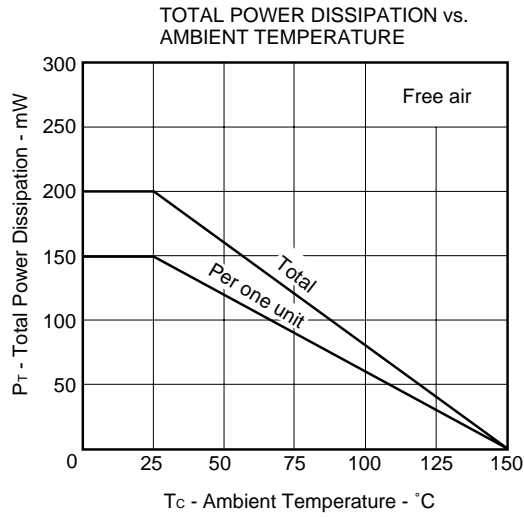

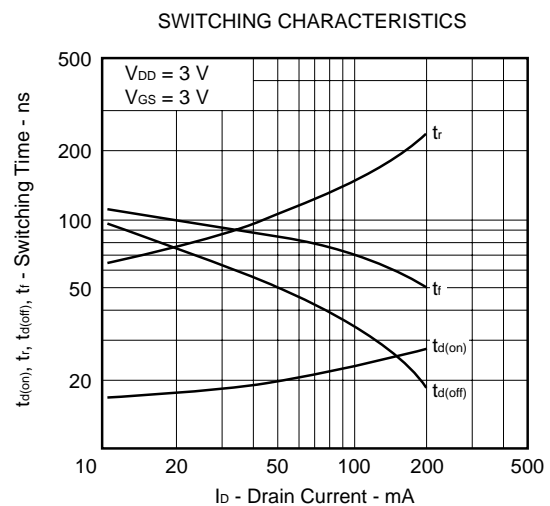
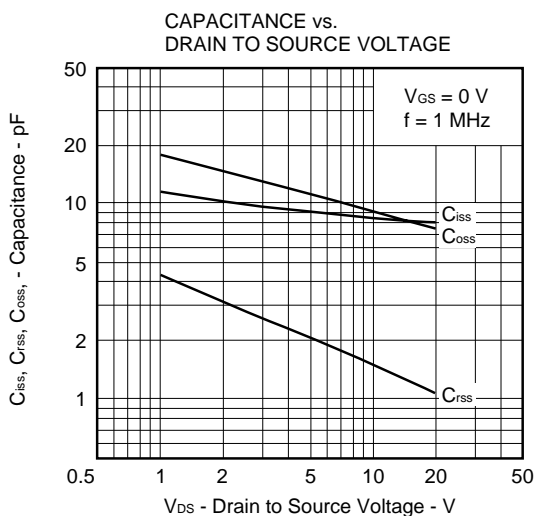
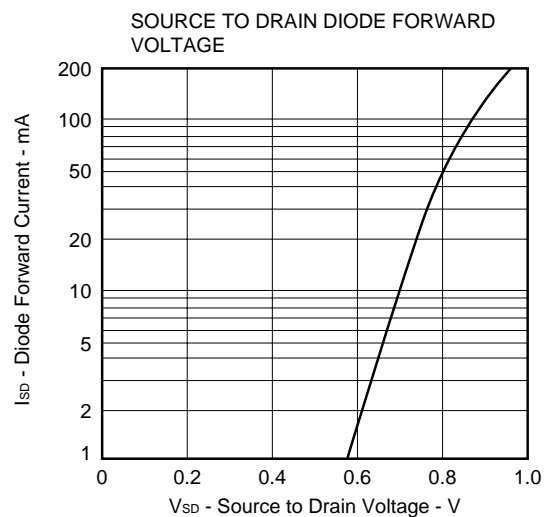
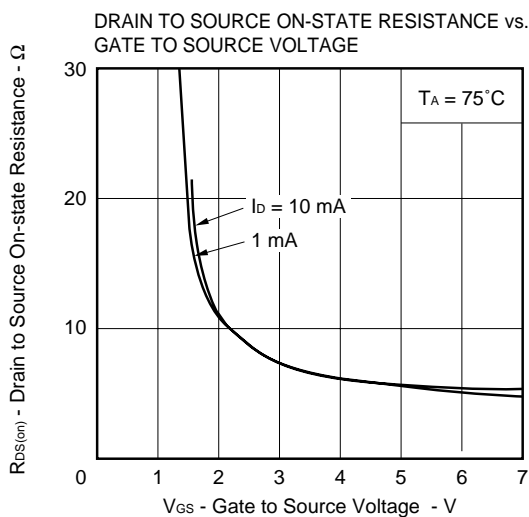
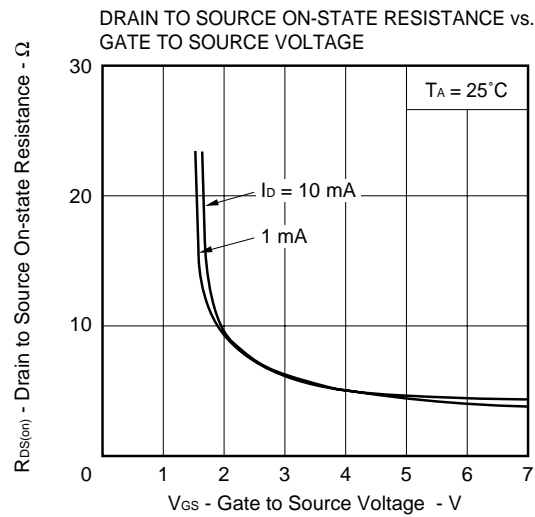
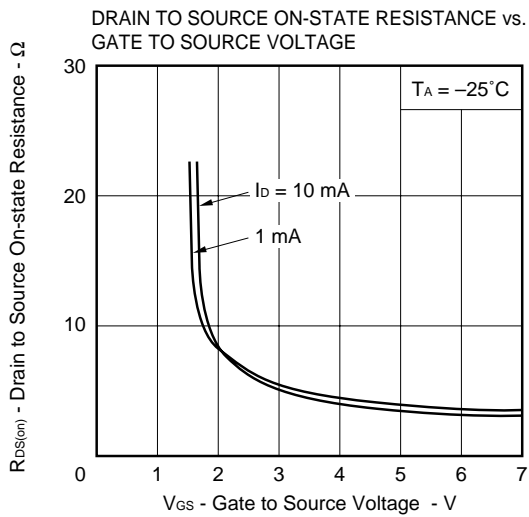

[MEMO]

[MEMO]

[MEMO]

- **The information in this document is current as of May, 2001. The information is subject to change without notice. For actual design-in, refer to the latest publications of NEC's data sheets or data books, etc., for the most up-to-date specifications of NEC semiconductor products. Not all products and/or types are available in every country. Please check with an NEC sales representative for availability and additional information.**
 - No part of this document may be copied or reproduced in any form or by any means without prior written consent of NEC. NEC assumes no responsibility for any errors that may appear in this document.
 - NEC does not assume any liability for infringement of patents, copyrights or other intellectual property rights of third parties by or arising from the use of NEC semiconductor products listed in this document or any other liability arising from the use of such products. No license, express, implied or otherwise, is granted under any patents, copyrights or other intellectual property rights of NEC or others.
 - Descriptions of circuits, software and other related information in this document are provided for illustrative purposes in semiconductor product operation and application examples. The incorporation of these circuits, software and information in the design of customer's equipment shall be done under the full responsibility of customer. NEC assumes no responsibility for any losses incurred by customers or third parties arising from the use of these circuits, software and information.
 - While NEC endeavours to enhance the quality, reliability and safety of NEC semiconductor products, customers agree and acknowledge that the possibility of defects thereof cannot be eliminated entirely. To minimize risks of damage to property or injury (including death) to persons arising from defects in NEC semiconductor products, customers must incorporate sufficient safety measures in their design, such as redundancy, fire-containment, and anti-failure features.
 - NEC semiconductor products are classified into the following three quality grades:
"Standard", "Special" and "Specific". The "Specific" quality grade applies only to semiconductor products developed based on a customer-designated "quality assurance program" for a specific application. The recommended applications of a semiconductor product depend on its quality grade, as indicated below. Customers must check the quality grade of each semiconductor product before using it in a particular application.
 - "Standard": Computers, office equipment, communications equipment, test and measurement equipment, audio and visual equipment, home electronic appliances, machine tools, personal electronic equipment and industrial robots
 - "Special": Transportation equipment (automobiles, trains, ships, etc.), traffic control systems, anti-disaster systems, anti-crime systems, safety equipment and medical equipment (not specifically designed for life support)
 - "Specific": Aircraft, aerospace equipment, submersible repeaters, nuclear reactor control systems, life support systems and medical equipment for life support, etc.
- The quality grade of NEC semiconductor products is "Standard" unless otherwise expressly specified in NEC's data sheets or data books, etc. If customers wish to use NEC semiconductor products in applications not intended by NEC, they must contact an NEC sales representative in advance to determine NEC's willingness to support a given application.
- (Note)
- (1) "NEC" as used in this statement means NEC Corporation and also includes its majority-owned subsidiaries.
 - (2) "NEC semiconductor products" means any semiconductor product developed or manufactured by or for NEC (as defined above).