

FEATURES

- 30 Volt Differential Input Range
- 75 nA Input Bias Current
- Wide Common Mode Voltage Range

APPLICATIONS

- Signal Conditioning Amplifiers
- Voltage Followers
- Comparators

DESCRIPTION

The LM101A and LM107 are general purpose operational amplifiers, featuring low bias current and the ability to operate with high input differential voltages up to 30 Volts. Unlike many FET input amplifiers, the output of the LM101A/107 does not reverse if the common mode range is exceeded, making them particularly useful in comparator and oscillator circuits.

The LM101A uses external compensation, allowing the frequency response and slew rate to be optimized for the application. The LM107 is identical to the LM101A with the exception that the compensation capacitor is internal. Linear's LM101A and LM107 include improved design and processing techniques resulting in superior long term stability and reliability over previous devices. The curve of bias current versus differential input voltage indicates that a minimal change in input current occurs over a wide range of input signal, which is important in many applications.

Wein Bridge Sine Wave Oscillator

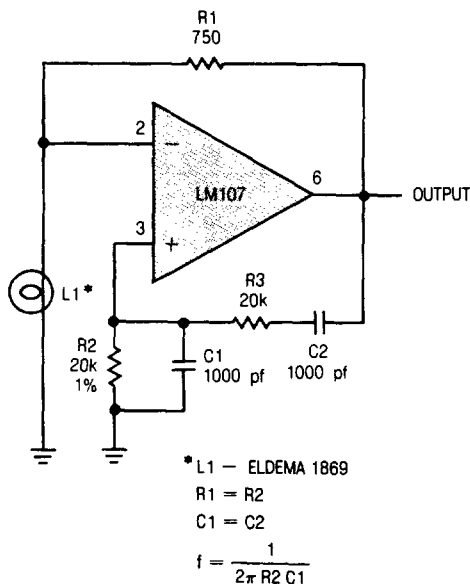

Bias Current vs Differential Input Voltage

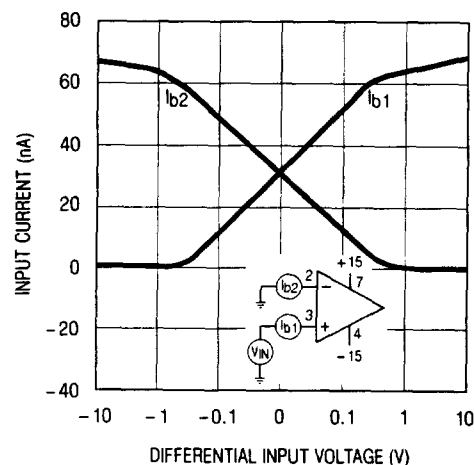

ABSOLUTE MAXIMUM RATINGS

Supply Voltage		
LM101A/LM107	± 22 Volts
LM301A/LM307	± 18 Volts
Differential Input Voltage	± 30 Volts
Input Voltage, Note 2	± 15 Volts
Output Short Circuit Duration, Note 3	Indefinite
Operating Temperature Range		
LM101A/LM107	-55°C to 125°C
LM301A/LM307	0°C to 70°C
Maximum Junction Temperature		
LM101A/LM107	150°C
LM301A/LM307	100°C
Storage Temperature Range		
All Devices	-65°C to 150°C
Lead Temperature (Soldering, 10 sec.)	300°C

PACKAGE/ORDER INFORMATION

<p>METAL CAN H PACKAGE * PINS 1, 5, 8 NO CONNECTION ON LM107/307</p>	ORDER PART NUMBER
	LM101AH LM301AH LM107H LM307H
<p>J8 PACKAGE HERMETIC DIP * PINS 1, 5, 8 NO CONNECTION ON LM107/307</p>	LM101AJ8 LM301AJ8 LM107J8 LM307J8

ELECTRICAL CHARACTERISTICS (Note 1)

SYMBOL	PARAMETER	CONDITIONS	LM101A/LM107			LM301A/LM307			UNITS
			MIN	TYP	MAX	MIN	TYP	MAX	
V_{OS}	Input Offset Voltage	$R_S \leq 50K\Omega$, $T_A = 25^\circ C$ $R_S \leq 50K\Omega$	●	0.7	2.0	2.0	7.5	mV	
$\frac{\Delta V_{OS}}{\Delta Temp}$	Average Temperature Coefficient of Input Offset Voltage	$R_S \leq 50K\Omega$	●	3.0	15	6.0	30	$\mu V/^\circ C$	
I_{OS}	Input Offset Current	$T_A = 25^\circ C$	●	1.5	10	3.0	50	nA	
$\frac{\Delta I_{OS}}{\Delta Temp}$	Average Temperature Coefficient of Input Offset Current	$25^\circ C \leq T_A \leq T_{MAX}$ $T_{MIN} \leq T_A \leq 25^\circ C$		0.01	0.1	0.01	0.3	nA/°C	
I_B	Input Bias Current	$T_A = 25^\circ C$	●	30	75	70	250	nA	
A_{VOL}	Large Signal Voltage Gain	$T_A = 25^\circ C$, $V_S \pm 15V$, $V_{OUT} = \pm 10V$, $R_L \geq 2K\Omega$ $V_S = \pm 15V$, $V_{OUT} = \pm 10V$, $R_L \geq 2K\Omega$	●	50	160	25	160	V/mV	
CMRR	Common Mode Rejection Ratio	$R_S \leq 50K\Omega$	●	80	96	70	90	dB	
PSRR	Power Supply Rejection Ratio	$R_S \leq 50K\Omega$	●	80	96	70	96	dB	
	Input Voltage Range	$V_S = \pm 20V$	●	± 15				V	
		$V_S = \pm 15V$	●	+ 15	- 13	± 12	+ 15	V	
			●	- 13		- 13		V	
V_{OUT}	Output Voltage Swing	$V_S = \pm 15V$, $R_L = 10K\Omega$ $R_L = 2K\Omega$	●	± 12	± 14	± 12	± 14	V	
			●	± 10	± 13	± 10	± 13	V	
R_{IN}	Input Resistance	$T_A = 25^\circ C$		1.5	4.0	0.5	2.0	M Ω	
I_S	Supply Current	$T_A = 25^\circ C$, $V_S = \pm 20V$ $T_A = 125^\circ C$, $V_S = \pm 20V$	●	1.8	3.0	1.8	3.0	mA	
			●	1.2	2.5			mA	

The ● denotes the specifications which apply over the full operating temperature range.

Note 1: Unless otherwise noted; all measurements are made with unity gain compensation ($C_1 = 30\text{pf}$ for the LM101A/301A); these specifications apply for $\pm 5V \leq V_S \leq \pm 20V$ for the LM101A/LM107; and $\pm 5V \leq V_S \leq \pm 15V$ for the LM301A/LM307.

Note 2: For supply voltages less than ± 15 Volts, the maximum input voltage is equal to the supply voltage.

Note 3: The output may be shorted to ground or either power supply indefinitely, provided the case temperature is below $125^\circ C$ for the LM101A/107 and below $70^\circ C$ for the LM301A/307.

TYPICAL PERFORMANCE CHARACTERISTICS (LM101A)

Single Pole Compensation

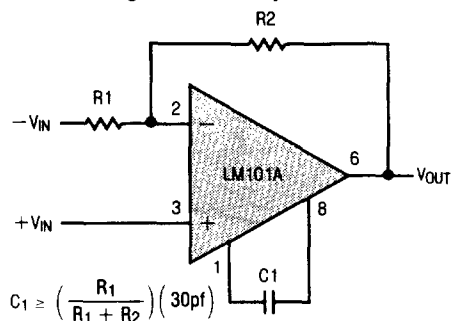

$$C_1 \geq \left(\frac{R_1}{R_1 + R_2} \right) (30 \text{ pf})$$

$C_1 = 30 \text{ pF}$ for unity gain stability. At gains above 1 frequency response can be maximized by decreasing C_1 .

Open Loop Frequency Response

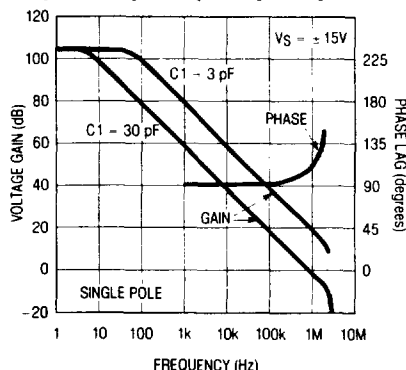

Single Pole Large Signal Frequency Response

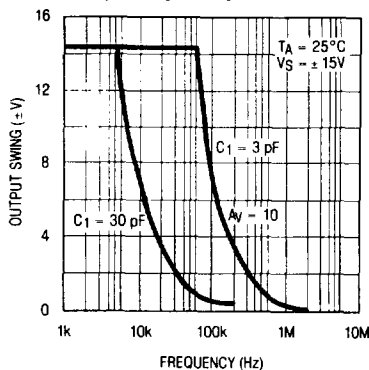

Single Pole Voltage Follower Pulse Response

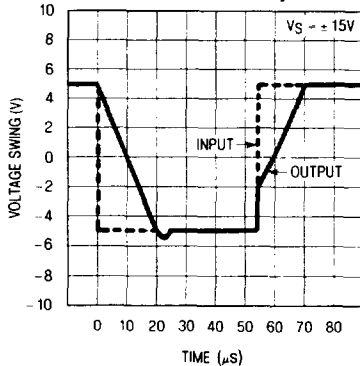

Two Pole Compensation

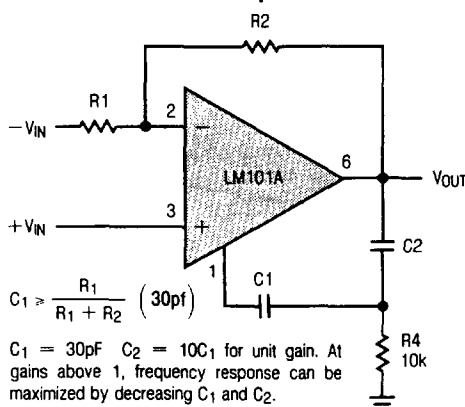

$$C_1 \geq \frac{R_1}{R_1 + R_2} (30 \text{ pf})$$

$C_1 = 30 \text{ pF}$ $C_2 = 10C_1$ for unit gain. At gains above 1, frequency response can be maximized by decreasing C_1 and C_2 .

Open Loop Frequency Response

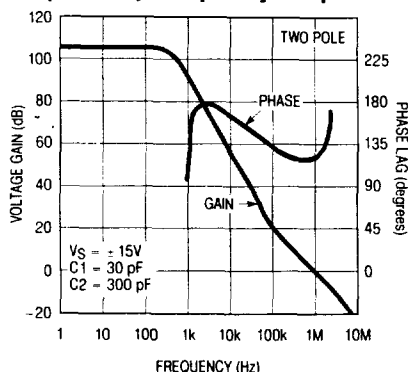

2 Pole Large Signal Frequency Response

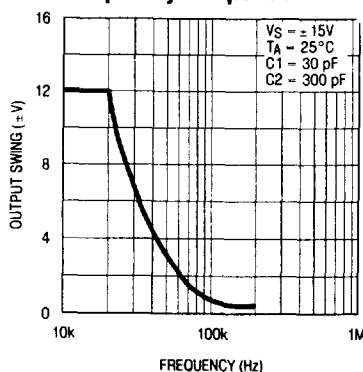

2 Pole Voltage Follower Pulse Response

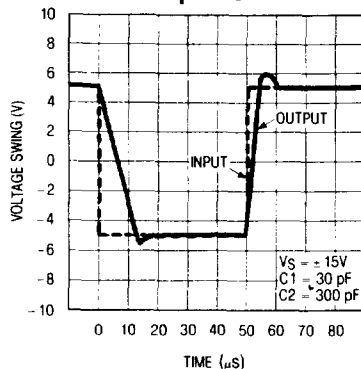

Feedforward Compensation

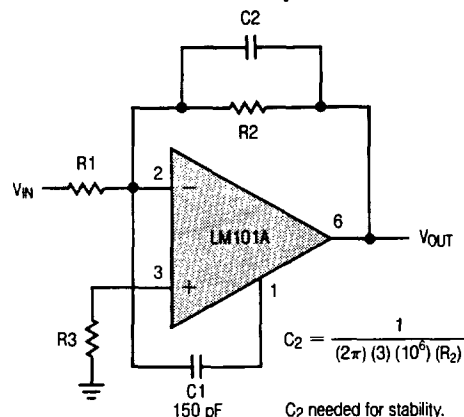

$$C_2 = \frac{1}{(2\pi)(3)(10^5)(R_2)}$$

C_2 needed for stability.

Open Loop Frequency Response

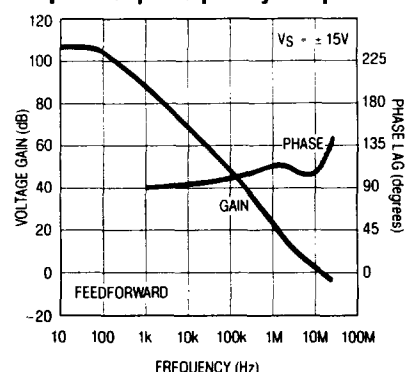

Feedforward Large Signal Frequency Response

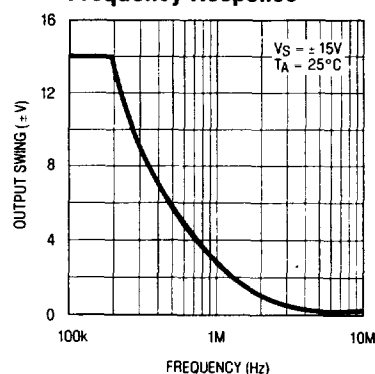

Feedforward Inverter Pulse Response

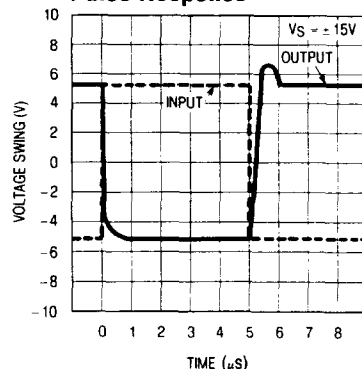

2

TYPICAL PERFORMANCE CHARACTERISTICS (LM101A/LM107)

Input Current

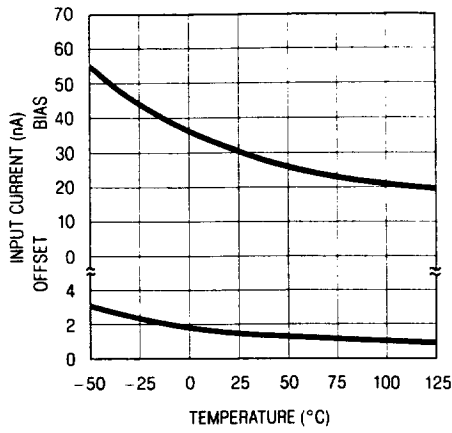

Supply Current

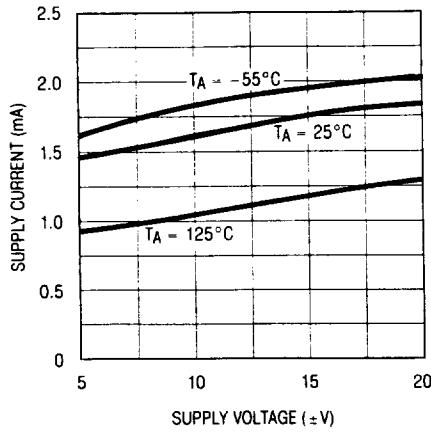

Voltage Gain

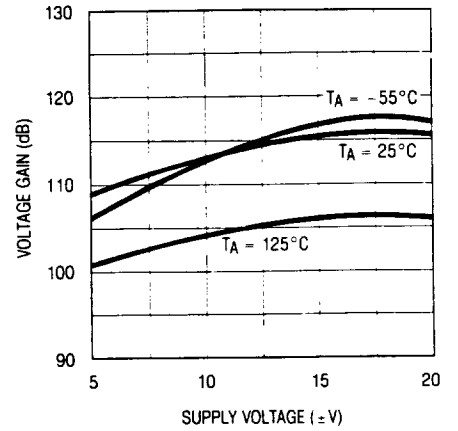

Input Noise Voltage

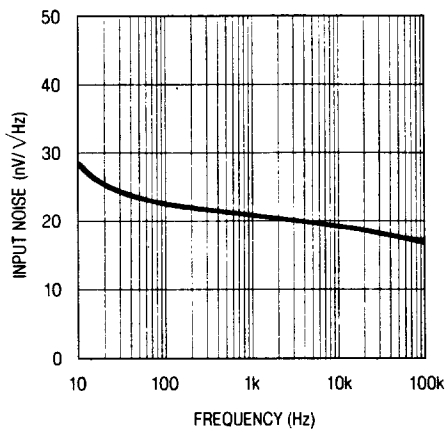

Input Noise Current

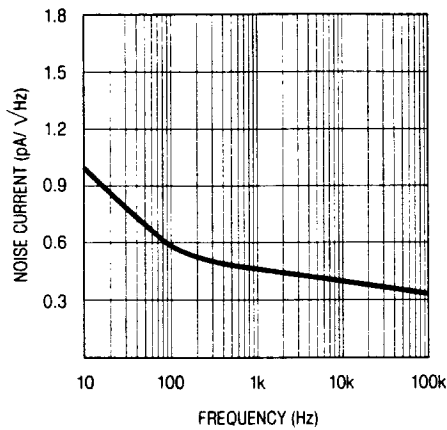

Current Limiting

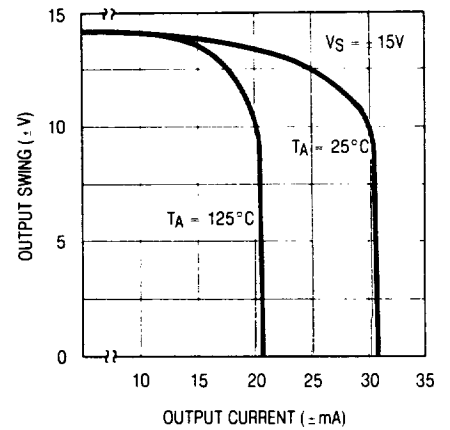

Common Mode Rejection

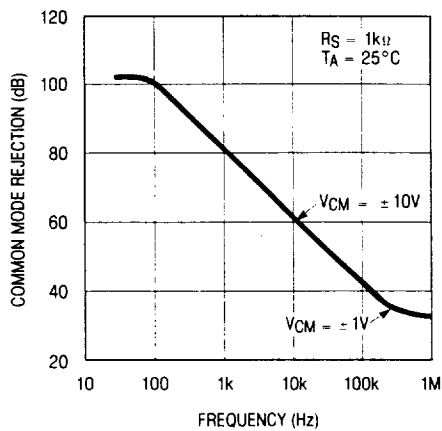

Power Supply Rejection

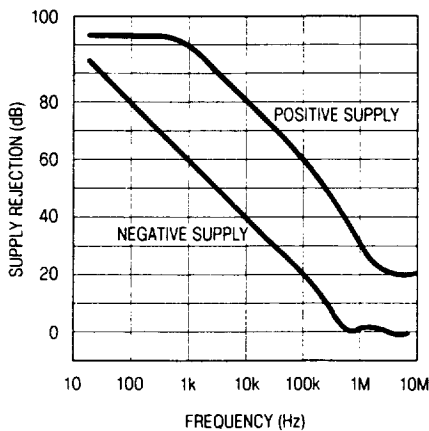

Closed Loop Output Impedance

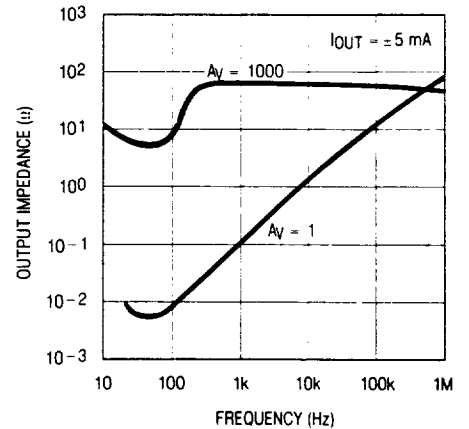

LM107
Open Loop Frequency Response

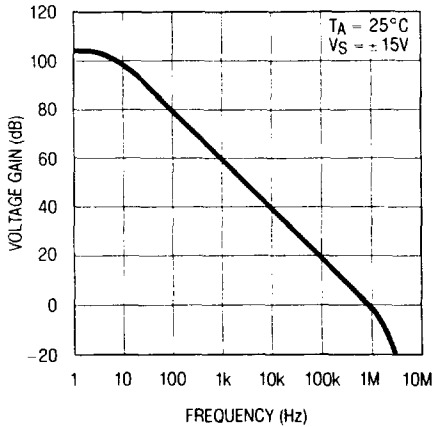

LM107
Large Signal Frequency Response

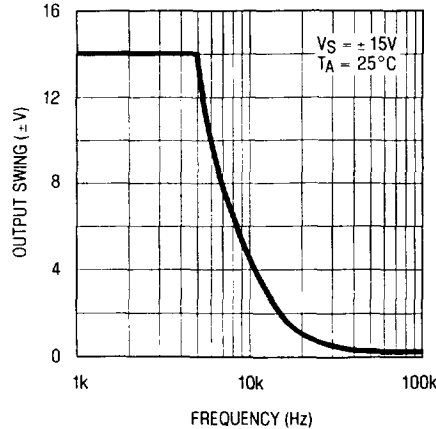

LM107
Voltage Follower Pulse Response

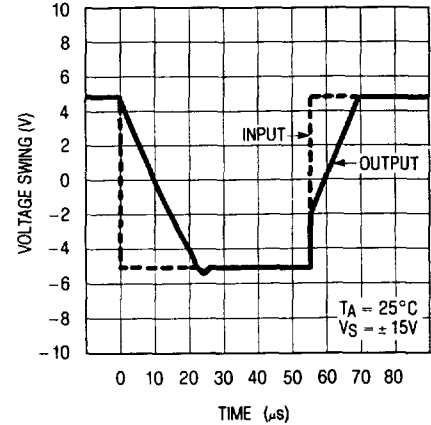

TYPICAL APPLICATIONS

2

Standard Compensation and Offset Balancing Circuit

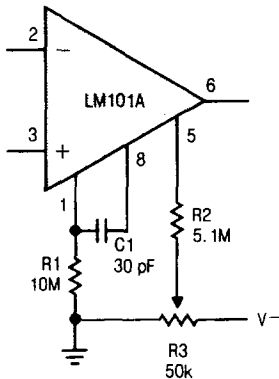

Fast Summing Amplifier

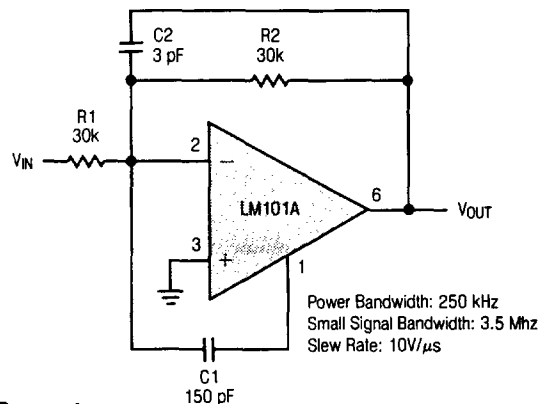

Fast Voltage Follower

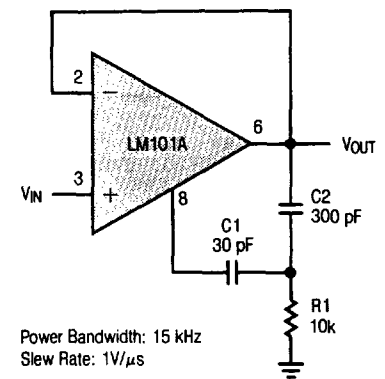

Low Frequency Square Wave Generator

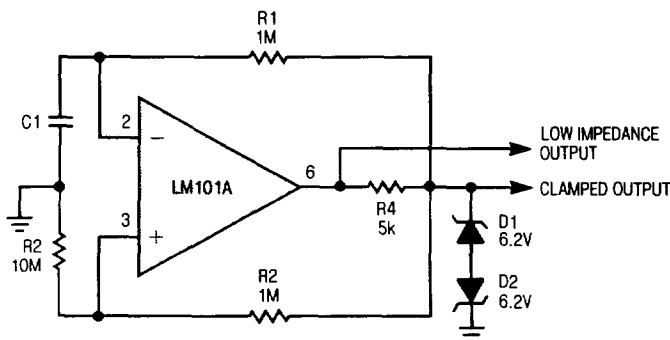

Voltage Comparator with Clamp

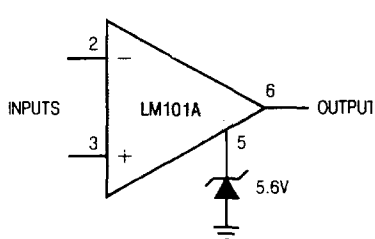

Precision Rectifier

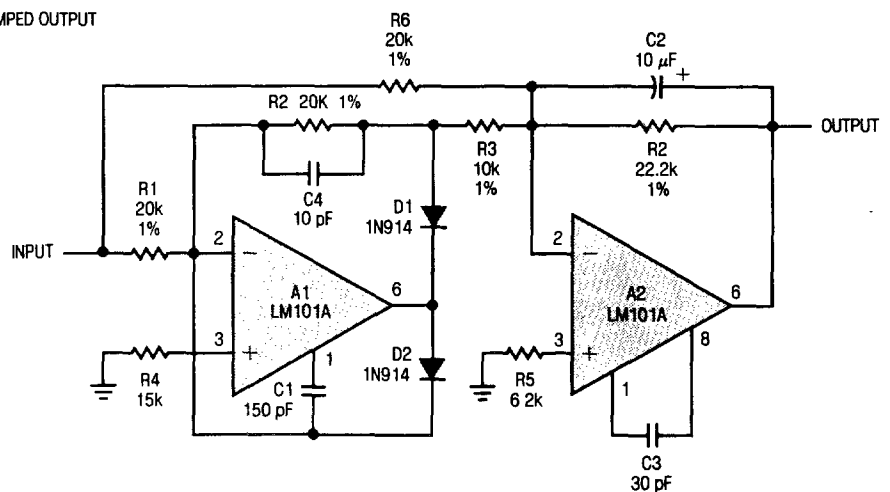

SCHEMATIC DIAGRAM

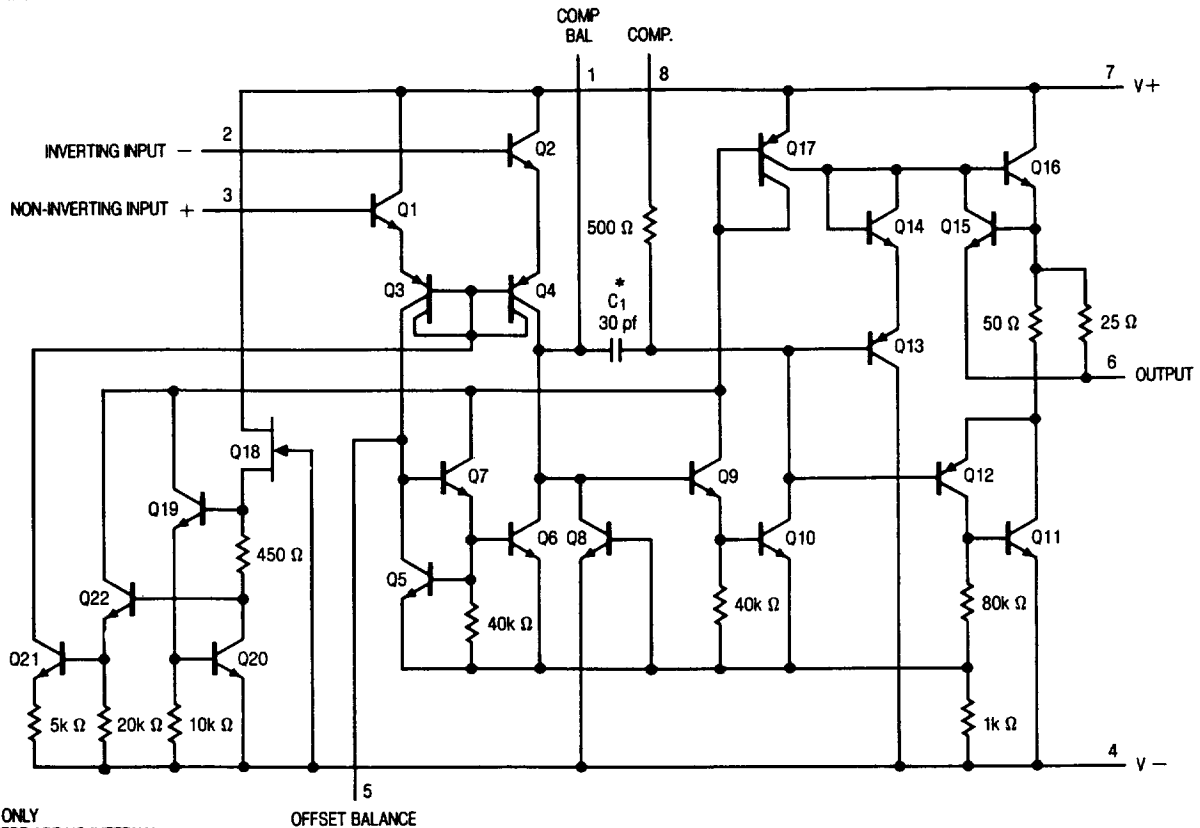

* C1 FOR LM107 ONLY
FOR LM107, THERE ARE NO INTERNAL
CONNECTIONS TO PINS 1, 5 AND 8

PACKAGE DESCRIPTION

**H Package
Metal Can**

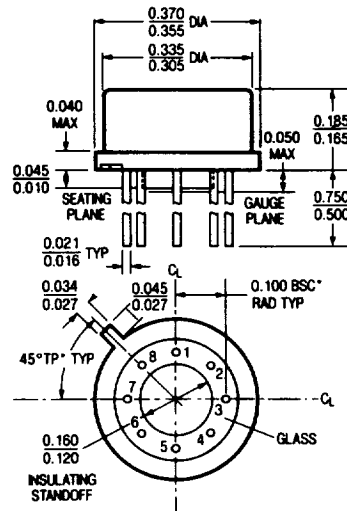

NOTE: DIMENSIONS IN INCHES

T_{jmax}	θ_{ja}	θ_{jc}
150°C	150°C/W	45°C/W

**J8 Package
8 Lead Hermetic Dip**

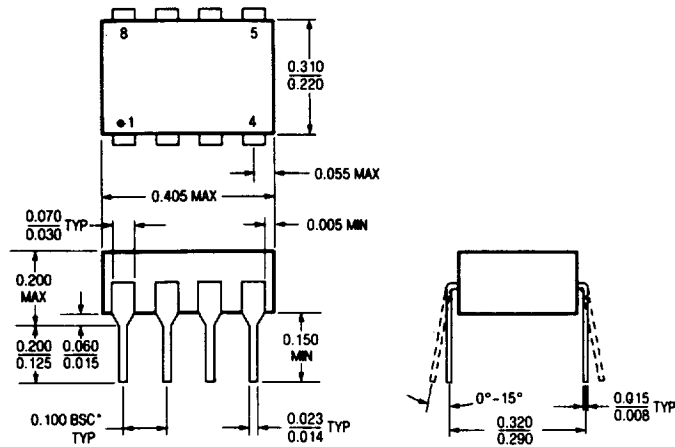

NOTE: DIMENSIONS IN INCHES UNLESS OTHERWISE NOTED.
*LEADS WITHIN 0.007 OF TRUE POSITION (TP) AT GAUGE PLANE

T_{jmax}	θ_{ja}
150°C	100°C/W