



STP95N04 STD95N04

N-CHANNEL 40V - 5.4mΩ - 80A - DPAK - TO-220
STripFET™ Power MOSFET

General features

Type	V _{DSS}	R _{DS(on)}	I _D	P _w
STD95N04	40V	<6.5mΩ	80A	110W
STP95N04	40V	<6.5mΩ	80A	110W

- STANDARD THRESHOLD DRIVE
- 100% AVALANCHE TESTED

Description

This N-Channel enhancement mode MOSFET is the latest refinement of STMicroelectronic unique "Single Feature Size™" strip-based process with less critical alignment steps and therefore a remarkable manufacturing reproducibility. The resulting transistor shows extremely high packing density for low on-resistance, rugged avalanche characteristics and low gate charge.

Applications

- HIGH CURRENT, SWITCHING APPLICATION
- AUTOMOTIVE

Order codes

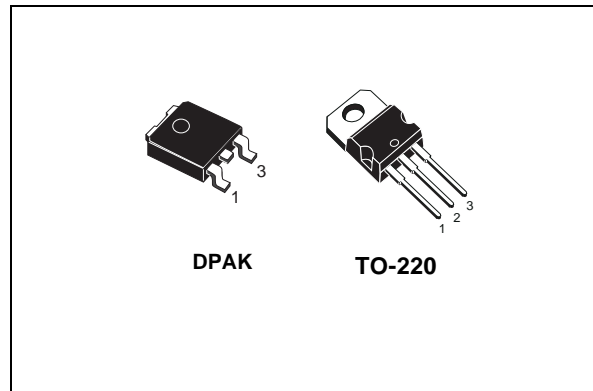

Internal schematic diagram

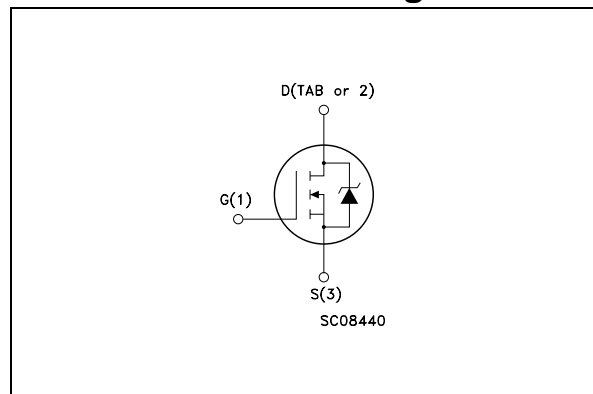

Sales Type	Marking	Package	Packaging
STD95N04	D95N04	DPAK	TAPE & REEL
STP95N04	P95N04	TO-220	TUBE

1 Electrical ratings

Table 1. Absolute maximum ratings

Symbol	Parameter	Value	Unit
V_{DS}	Drain-source Voltage ($V_{GS}=0$)	40	V
V_{GS}	Gate-Source Voltage	± 20	V
I_D <i>Note 1</i>	Drain Current (continuous) at $T_C = 25^\circ\text{C}$	80	A
I_D	Drain Current (continuous) at $T_C = 100^\circ\text{C}$	65	A
I_{DM} <i>Note 2</i>	Drain Current (pulsed)	320	A
P_{TOT}	Total Dissipation at $T_C = 25^\circ\text{C}$	110	W
	Derating Factor	0.73	W/ $^\circ\text{C}$
dv/dt <i>Note 3</i>	Peak Diode Recovery voltage slope	8	V/ns
E_{AS} <i>Note 4</i>	Single Pulse Avalanche Energy	400	mJ
T_j T_{stg}	Operating Junction Temperature Storage Temperature	-55 to 175	$^\circ\text{C}$

Table 2. Thermal data

		TO-220	DPAK	
Rthj-case	Thermal Resistance Junction-case Max	1.36		$^\circ\text{C}/\text{W}$
Rthj-a	Thermal Resistance Junction-ambient Max	62.5	--	$^\circ\text{C}/\text{W}$
Rthj-pcb <i>Note 5</i>	Thermal Resistance Junction-ambient Max	--	50	$^\circ\text{C}/\text{W}$
T_l	Maximum Lead Temperature For Soldering Purpose	300	--	$^\circ\text{C}$

2 Electrical characteristics

(T_{CASE} = 25 °C unless otherwise specified)

Table 3. On/off states

Symbol	Parameter	Test Conditions	Min.	Typ.	Max.	Unit
V _{(BR)DSS}	Drain-Source Breakdown Voltage	I _D = 250μA, V _{GS} = 0	40			V
I _{DSS}	Zero Gate Voltage Drain Current (V _{GS} = 0)	V _{DS} = Max Rating, V _{DS} = Max Rating, T _c = 125°C			10 100	μA μA
I _{GSS}	Gate Body Leakage Current (V _{DS} = 0)	V _{GS} = ±20V			±200	nA
V _{GS(th)}	Gate Threshold Voltage	V _{DS} = V _{GS} , I _D = 250μA	2		4	V
R _{DS(on)}	Static Drain-Source On Resistance	V _{GS} = 10V, I _D = 40A		5.4	6.5	mΩ

Table 4. Dynamic

Symbol	Parameter	Test Conditions	Min.	Typ.	Max.	Unit
g _{fs} <i>Note 6</i>	Forward Transconductance	V _{DS} = 25V, I _D = 40A		100		S
C _{iss}	Input Capacitance	V _{DS} = 25V, f = 1 MHz, V _{GS} = 0		2200		pF
C _{oss}	Output Capacitance			580		pF
C _{rss}	Reverse Transfer Capacitance			40		pF
Q _g	Total Gate Charge	V _{DD} = 20V, I _D = 80A		40	54	nC
Q _{gs}	Gate-Source Charge	V _{GS} = 10V		11		nC
Q _{gd}	Gate-Drain Charge	(see Figure 13)		8		nC

Table 5. Switching times

Symbol	Parameter	Test Conditions	Min.	Typ.	Max.	Unit
$t_{d(on)}$ t_r	Turn-on Delay Time Rise Time	$V_{DD}=20V$, $I_D=40A$, $R_G=4.7\Omega$, $V_{GS}=10V$ (see Figure 12)		15 50		ns ns
$t_{d(off)}$ t_f	Turn-off Delay Time FallTime	$V_{DD}=20V$, $I_D=40A$, $R_G=4.7\Omega$, $V_{GS}=10V$ (see Figure 12)		40 15		ns ns

Table 6. Source drain diode

Symbol	Parameter	Test Conditions	Min.	Typ.	Max.	Unit
I_{SD} I_{SDM} <i>Note 2</i>	Source-drain Current Source-drain Current (pulsed)				80 320	A A
V_{SD} <i>Note 6</i>	Forward on Voltage	$I_{SD}=80A$, $V_{GS}=0$			1.5	V
t_{rr} Q_{rr} I_{RRM}	Reverse Recovery Time Reverse Recovery Charge Reverse Recovery Current	$I_{SD}=80A$, $di/dt = 100A/\mu s$, $V_{DD}=30V$, $T_j=150^\circ C$		45 60 2.8		ns nC A

- (1) Current limited by package
(2) Pulse width limited by safe operating area
(3) $I_{SD} \leq 80 A$, $di/dt \leq 400A/\mu s$, $V_{DS} \leq V_{(BR)DSS}$, $T_j \leq T_{jmax}$
(4) Starting $T_j=25^\circ C$, $I_d=40A$, $V_{dd}=30V$
(5) When mounted on 1inch² FR4 2Oz Cu board
(6) Pulsed: pulse duration = 300 μs , duty cycle 1.5%

2.1 Electrical characteristics (curves)

Figure 1. Safe Operating Area

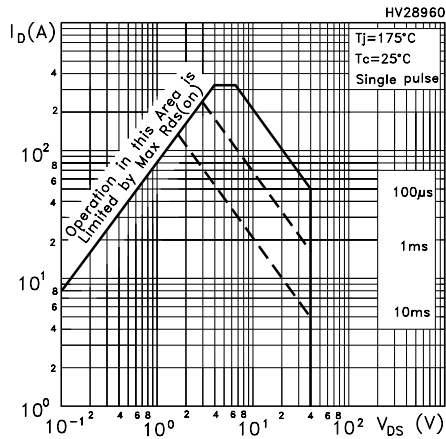

Figure 2. Thermal Impedance

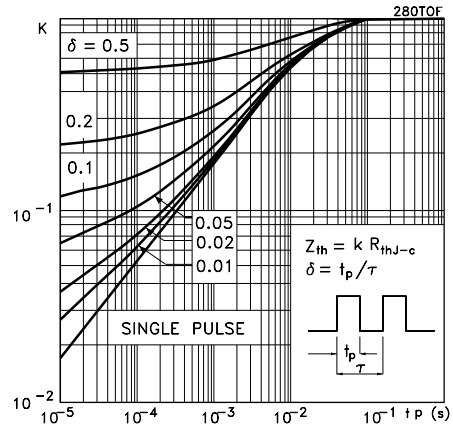

Figure 3. Output Characteristics

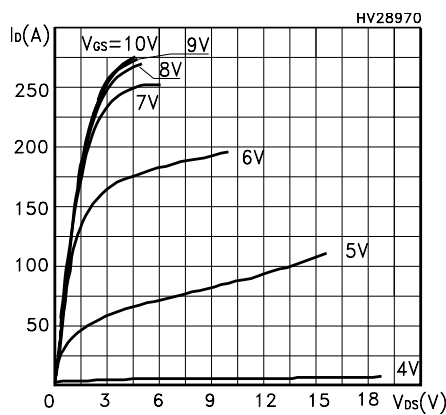

Figure 4. Transfer Characteristics

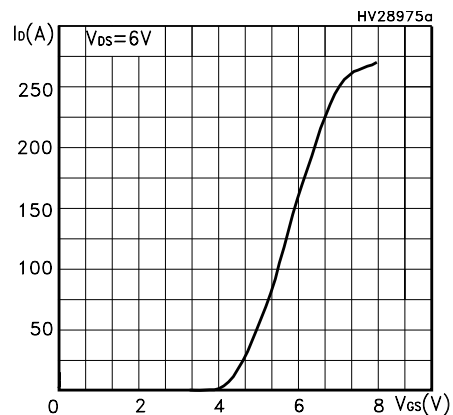

Figure 5. Static Drain-source on Resistance

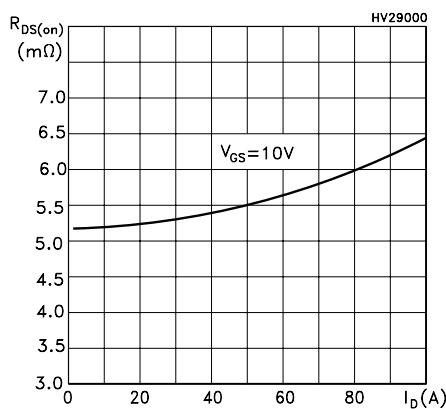

Figure 6. Normalized BVDSS vs Temperature

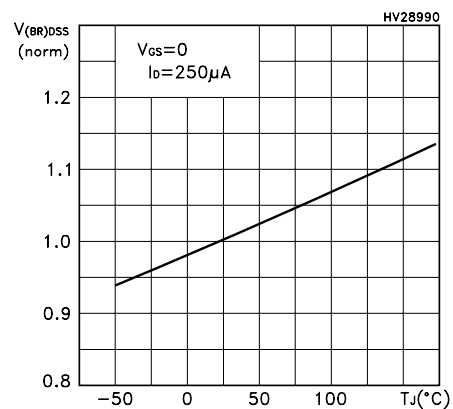

Figure 7. Gate Charge vs Gate-source Voltage Figure 8. Capacitance Variations

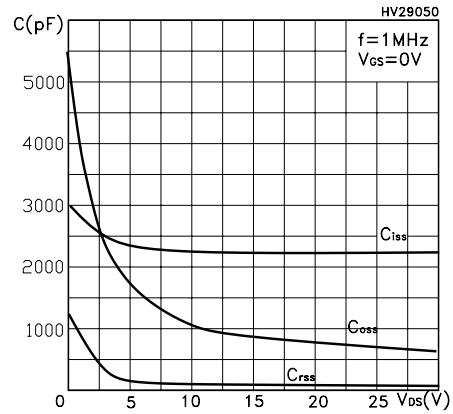
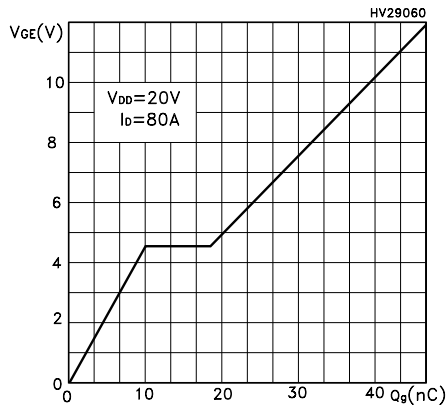

Figure 9. Normalized Gate Threshold Voltage vs Temperature Figure 10. Normalized on Resistance vs Temperature

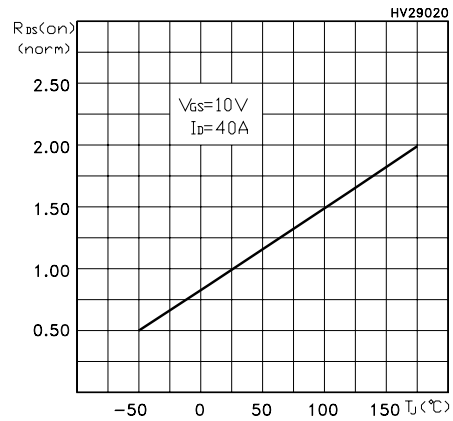
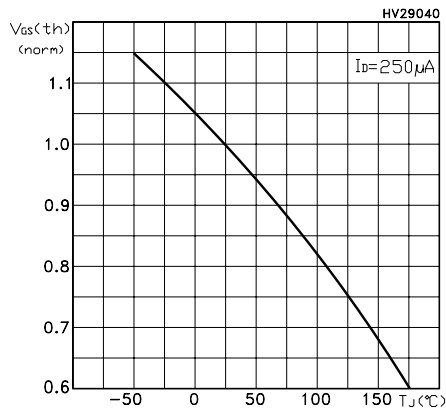
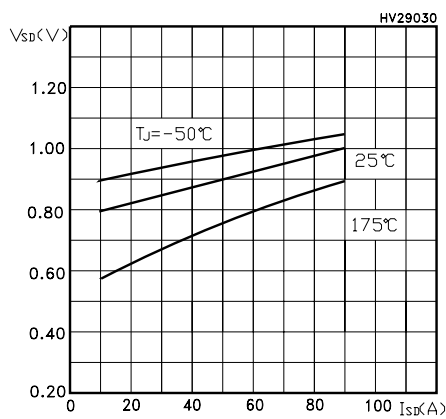

Figure 11. Source-drain Diode Forward Characteristics



3 Test circuits

Figure 12. Switching Times Test Circuit for Resistive Load

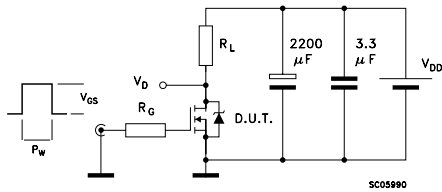

Figure 13. Gate Charge Test Circuit

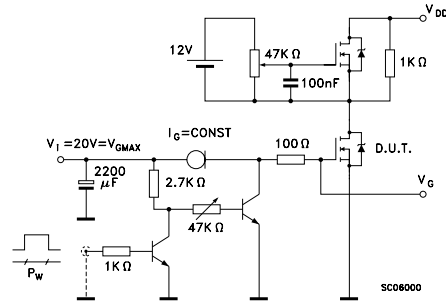

Figure 14. Test Circuit for Inductive Load Switching and Diode Recovery Times

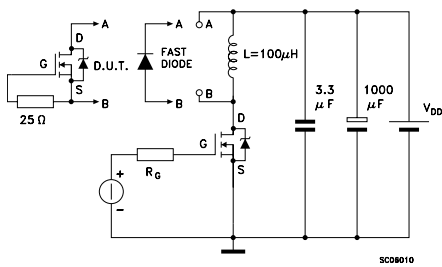

Figure 15. Unclamped Inductive Load Test Circuit

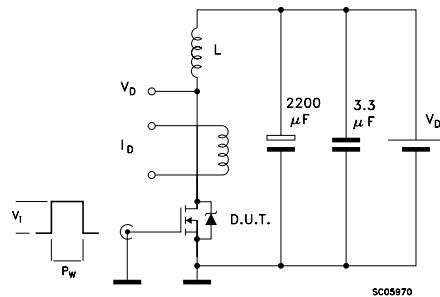

Figure 16. Unclamped Inductive Waveform

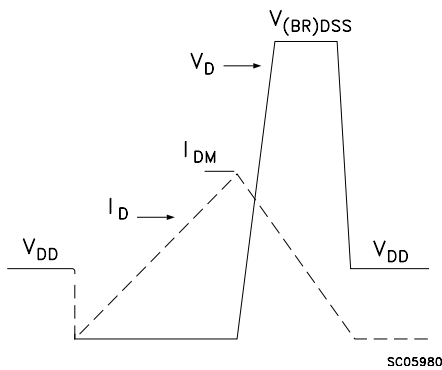

Figure 17. Switching Time Waveform

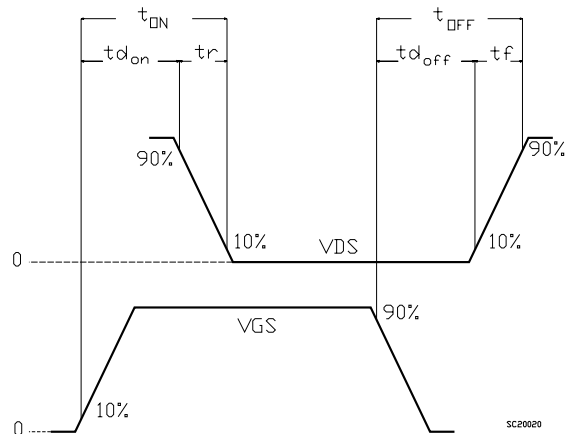
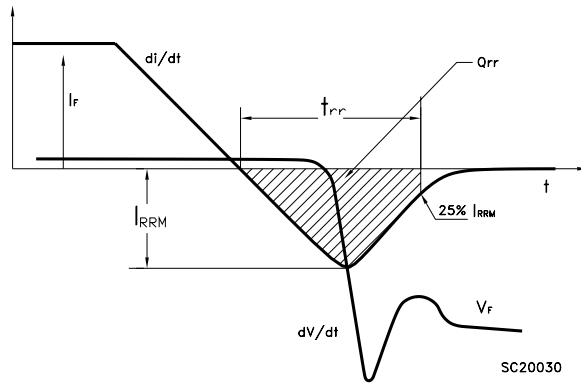

Figure 18. Diode Reverse Recovery Waveform



4 Package mechanical data

In order to meet environmental requirements, ST offers these devices in ECOPACK® packages. These packages have a Lead-free second level interconnect . The category of second level interconnect is marked on the package and on the inner box label, in compliance with JEDEC Standard JESD97. The maximum ratings related to soldering conditions are also marked on the inner box label. ECOPACK is an ST trademark. ECOPACK specifications are available at: www.st.com

TO-252 (DPAK) MECHANICAL DATA

DIM.	mm			inch		
	MIN.	TYP.	MAX.	MIN.	TYP.	MAX.
A	2.20		2.40	0.087		0.094
A1	0.90		1.10	0.035		0.043
A2	0.03		0.23	0.001		0.009
B	0.64		0.90	0.025		0.035
B2	5.20		5.40	0.204		0.213
C	0.45		0.60	0.018		0.024
C2	0.48		0.60	0.019		0.024
D	6.00		6.20	0.236		0.244
E	6.40		6.60	0.252		0.260
G	4.40		4.60	0.173		0.181
H	9.35		10.10	0.368		0.398
L2		0.8			0.031	
L4	0.60		1.00	0.024		0.039
V2	0°		8°	0°		0°

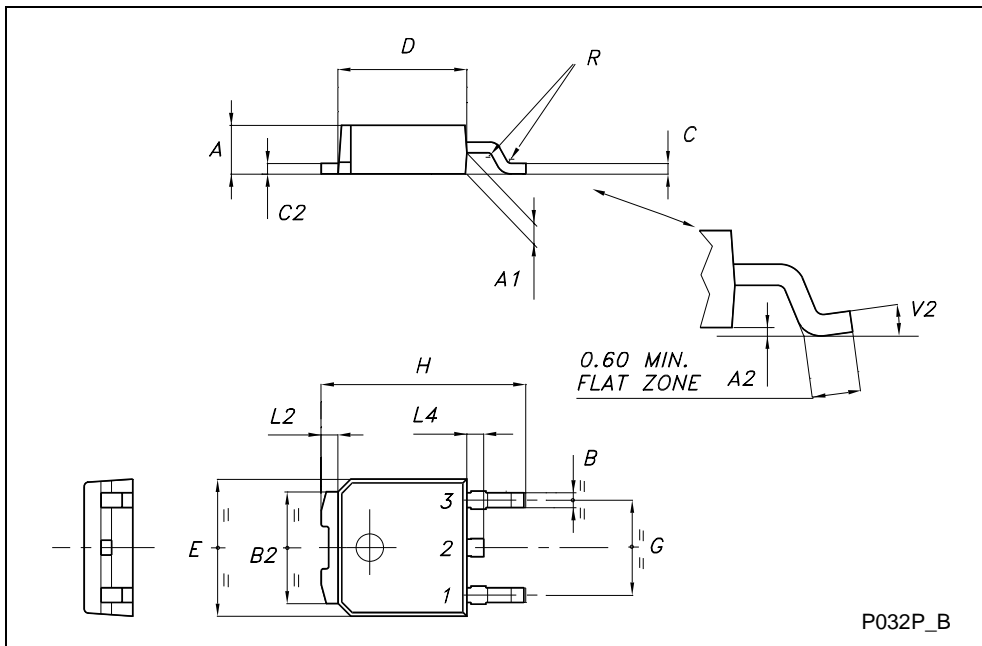

TO-220 MECHANICAL DATA

DIM.	mm.			inch		
	MIN.	TYP.	MAX.	MIN.	TYP.	MAX.
A	4.40		4.60	0.173		0.181
b	0.61		0.88	0.024		0.034
b1	1.15		1.70	0.045		0.066
c	0.49		0.70	0.019		0.027
D	15.25		15.75	0.60		0.620
E	10		10.40	0.393		0.409
e	2.40		2.70	0.094		0.106
e1	4.95		5.15	0.194		0.202
F	1.23		1.32	0.048		0.052
H1	6.20		6.60	0.244		0.256
J1	2.40		2.72	0.094		0.107
L	13		14	0.511		0.551
L1	3.50		3.93	0.137		0.154
L20		16.40			0.645	
L30		28.90			1.137	
øP	3.75		3.85	0.147		0.151
Q	2.65		2.95	0.104		0.116

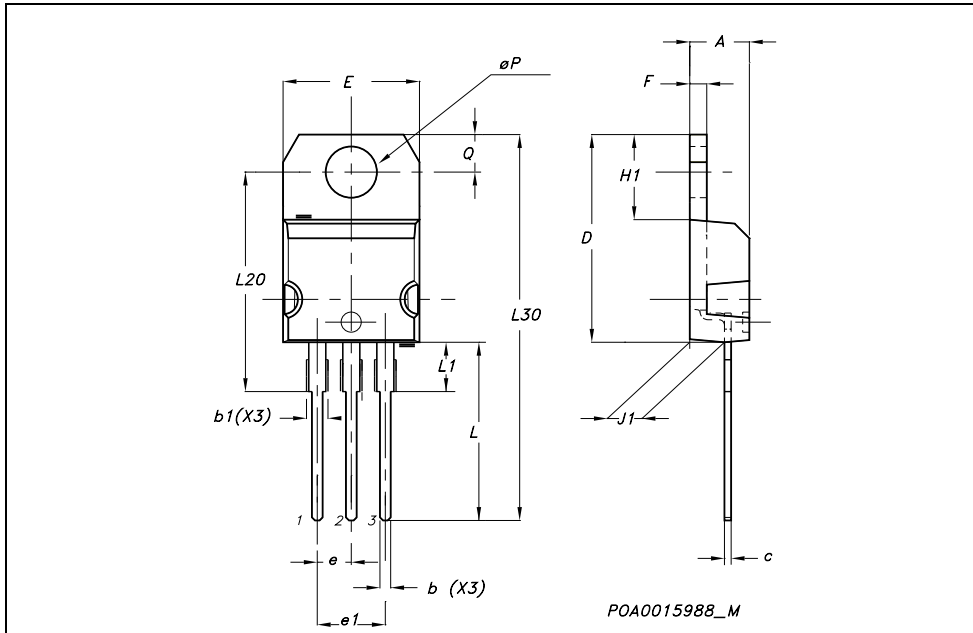

5 Packing mechanical data

DPAK FOOTPRINT

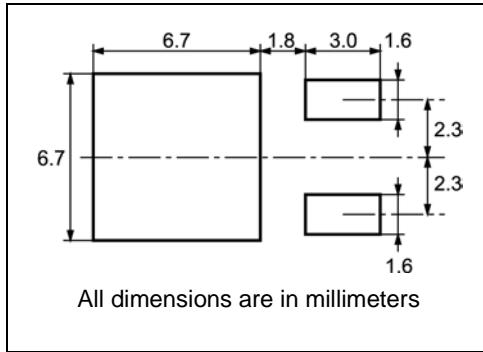

TAPE AND REEL SHIPMENT

REEL MECHANICAL DATA

DIM.	mm		inch	
	MIN.	MAX.	MIN.	MAX.
A		330		12.992
B	1.5		0.059	
C	12.8	13.2	0.504	0.520
D	20.2		0.795	
G	16.4	18.4	0.645	0.724
N	50		1.968	
T		22.4		0.881

BASE QTY	BULK QTY
2500	2500

TAPE MECHANICAL DATA

DIM.	mm		inch	
	MIN.	MAX.	MIN.	MAX.
A0	6.8	7	0.267	0.275
B0	10.4	10.6	0.409	0.417
B1		12.1		0.476
D	1.5	1.6	0.059	0.063
D1	1.5		0.059	
E	1.65	1.85	0.065	0.073
F	7.4	7.6	0.291	0.299
K0	2.55	2.75	0.100	0.108
P0	3.9	4.1	0.153	0.161
P1	7.9	8.1	0.311	0.319
P2	1.9	2.1	0.075	0.082
R	40		1.574	
W	15.7	16.3	0.618	0.641

6 Revision History

Date	Revision	Changes
24-Oct-2005	2	Inserted ecopack indication
07-Dec-2005	3	Complete version

Information furnished is believed to be accurate and reliable. However, STMicroelectronics assumes no responsibility for the consequences of use of such information nor for any infringement of patents or other rights of third parties which may result from its use. No license is granted by implication or otherwise under any patent or patent rights of STMicroelectronics. Specifications mentioned in this publication are subject to change without notice. This publication supersedes and replaces all information previously supplied. STMicroelectronics products are not authorized for use as critical components in life support devices or systems without express written approval of STMicroelectronics.

The ST logo is a registered trademark of STMicroelectronics.
All other names are the property of their respective owners

© 2005 STMicroelectronics - All rights reserved

STMicroelectronics group of companies

Australia - Belgium - Brazil - Canada - China - Czech Republic - Finland - France - Germany - Hong Kong - India - Israel - Italy - Japan -
Malaysia - Malta - Morocco - Singapore - Spain - Sweden - Switzerland - United Kingdom - United States of America

www.st.com