

STR9000 Series

5-Terminal, Low Dropout Voltage Dropper Type

■Features

- 5-terminal regulator with two screw mount package
- Output current: 4.0A
- Low dropout voltage : $V_{DIF} \leq 1V$ (at $I_o=4A$)
- Fine adjustment of output voltage
- Output ON/OFF control
- Built-in foldback overcurrent protection circuits

■Applications

- For stabilization of the secondary stage of switching power supplies
- Electronic equipment

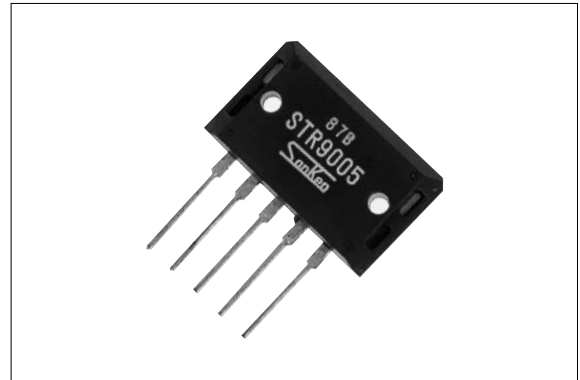

■Absolute Maximum Ratings

($T_a=25^\circ C$)

Parameter	Symbol	Ratings		Unit
		STR9005	STR9012/9015	
DC Input Voltage	V_{IN}	25	30	V
DC Output Current	I_o	4.0		A
Power Dissipation	P_{D1}	75($T_c=25^\circ C$)		W
	P_{D2}	3.2(Without heatsink, stand-alone operation)		W
Junction Temperature	T_j	-30 to +125		$^\circ C$
Ambient Operating Temperature	T_{op}	-20 to +100		$^\circ C$
Storage Temperature	T_{stg}	-30 to +125		$^\circ C$
Thermal Resistance (junction to case)	$R_{th(j-c)}$	1.25		$^\circ C/W$

■Electrical Characteristics

($T_a=25^\circ C$)

Parameter	Symbol	Ratings									Unit
		STR9005			STR9012			STR9015			
		min.	typ.	max.	min.	typ.	max.	min.	typ.	max.	
Input Voltage	V_{IN}	6		15	13		25	16		25	V
Output Voltage	V_o	4.9	5.0	5.1	11.8	12.0	12.2	14.8	15.0	15.2	V
	Conditions	$V_{IN}=8V, I_o=2.0A$			$V_{IN}=16V, I_o=2.0A$			$V_{IN}=20V, I_o=2.0A$			
Dropout Voltage	V_{DIF}			0.5			0.5			0.5	V
	Conditions	$I_o=2.0A$									
	Conditions			1.0			1.0			1.0	
Line Regulation	ΔV_{OLINE}		10	30		30	80		50	100	mV
	Conditions	$V_{IN}=6$ to 15V, $I_o=2.0A$			$V_{IN}=13$ to 25V, $I_o=2.0A$			$V_{IN}=16$ to 25V, $I_o=2.0A$			
	Conditions	$I_o=4.0A$									
Load Regulation	ΔV_{OLOAD}		40	100		80	200		100	200	mV
	Conditions	$V_{IN}=8V, I_o=0$ to 3.0A			$V_{IN}=16V, I_o=0$ to 3.0A			$V_{IN}=20V, I_o=0$ to 3.0A			
Temperature Coefficient of Output Voltage	$\Delta V_o/\Delta T_a$		± 0.5			± 1.5			± 1.5		mV/ $^\circ C$
Ripple Rejection	R_{REJ}		54			54			54		dB
	Conditions	$f=100$ to 120Hz									
Overcurrent Protection Starting Current	I_{s1}	4.1			4.1			4.1			A
	Conditions	$V_{IN}=8V$			$V_{IN}=16V$			$V_{IN}=20V$			
Output ON/OFF Control Voltage (Voltage between terminal No.3 and 5)	$V_o(ON)$			0.6			0.6			0.6	V
	$V_o(OFF)$	2.0			2.0			2.0			V
Voltage with Output Off	V_o			0.5			0.5			0.5	V
	Conditions	$V_{IN}=8V, I_o=0A$			$V_{IN}=15V, I_o=0A$			$V_{IN}=20V, I_o=0A$			

*Output is turned on when voltage between terminal No.3 and 5 is less than 0.6V, and turned off if more than 2.0V.

■Outline Drawing

(unit:mm)

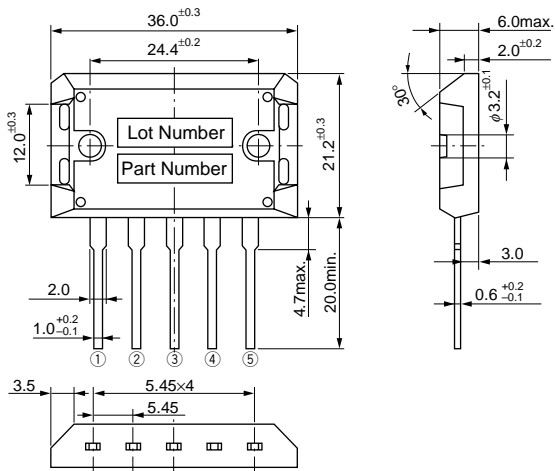

Plastic Mold Package Type
 Flammability: UL94V-0
 Weight: Approx. 14.5g

Terminal Connections

- ① Output (backside of case)
- ② Output Fine Adjustment
- ③ Output ON/OFF Control
- ④ Input
- ⑤ Ground

■Block Diagram

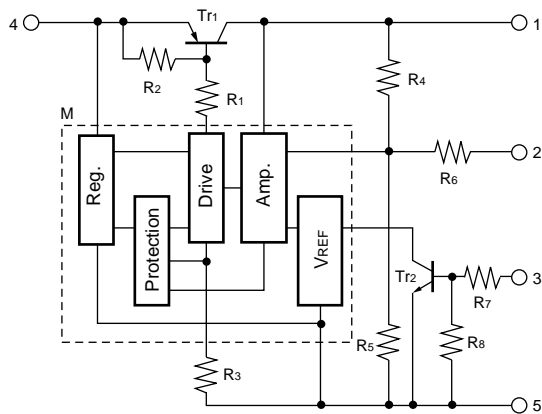

■Standard External Circuit

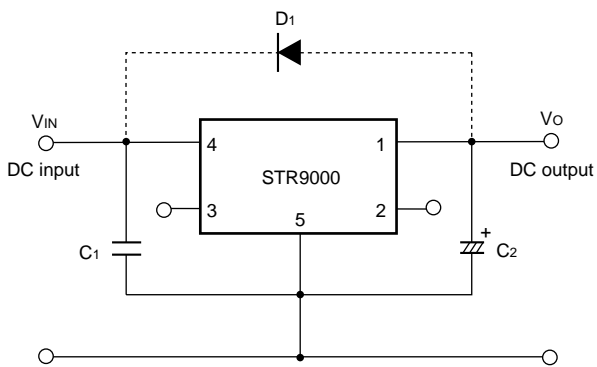

C1: Oscillation prevention capacitor (approx. 0.33 μ F)
 Connection to terminal No.4 must be made as short as possible.

C2: Output capacitor (47 to 100 μ F)
 Connection to terminal No.1 must be made as short as possible.

D1: Protection diode (RM1Z)
 Required for protection against reverse biasing of input and output.

Note 1: Prevention of oscillation at low temperatures
 At low temperatures, oscillation may occur unless an output capacitor with good $\tan\delta$ is used. Be sure to connect a tantalum capacitor (approx. 10 μ F) in parallel with output capacitor C2.

Note 2: An isolation type diode is provided from input to ground and also from output to ground. These may be destroyed if the device is reverse biased. In this case, use a diode with low V_F to protect them.

■ T_a - P_D Characteristics

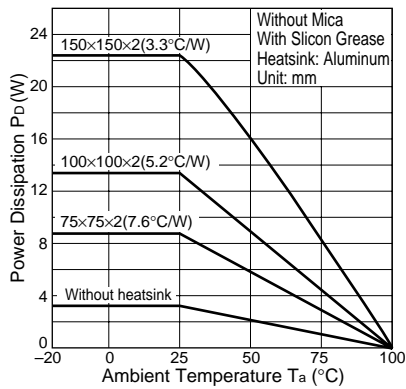

External Variable Output Voltage Circuit

1. Variable output voltage with a single external resistor

The output voltage of the STR9000 series may be decreased by inserting a resistor between terminals No.1 (output terminal) and No.2 (output fine adjustment terminals). Alternatively, the output voltage may be increased by inserting a resistor between terminals No.2 and No.5 (ground terminal).

<Standard External Circuit>

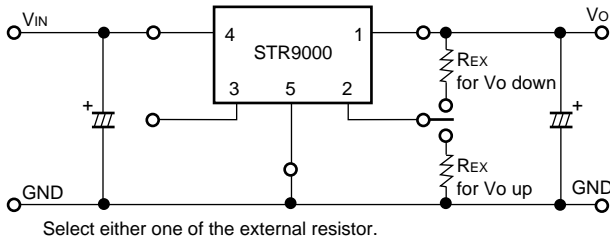

2. Fine adjustment of output voltage

The output voltage may be finely adjusted by using terminals No.1, No.2 and No.5 as shown in the following connections.

<Standard External Circuit>

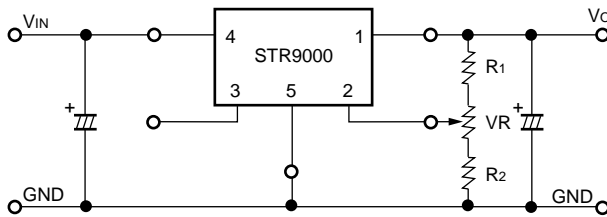

Note: The fine adjustment range of output voltage for the STR9000 series is $\pm 0.5V$ max for STR9012 and $+1.0V/-2.0V$ max for STR9015. Adjustment exceeding these values may cause start-up errors.

① Typical Characteristics of Variable Output Voltage

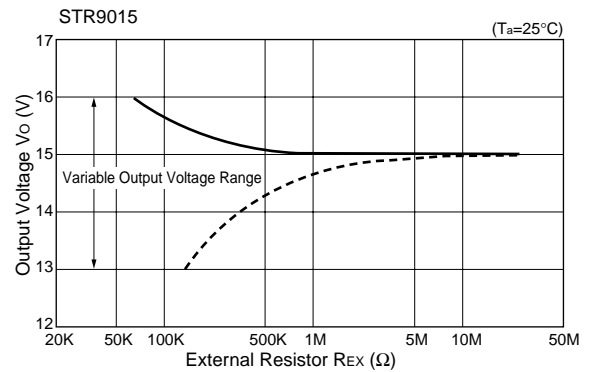
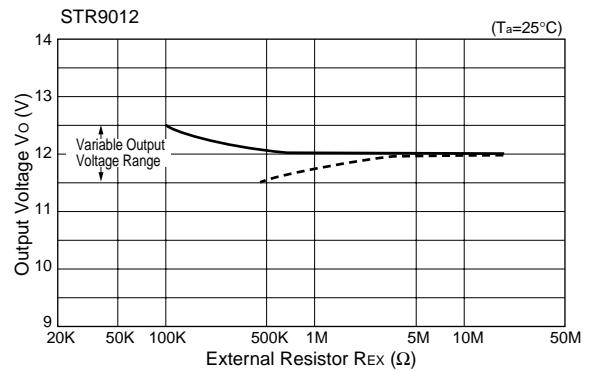
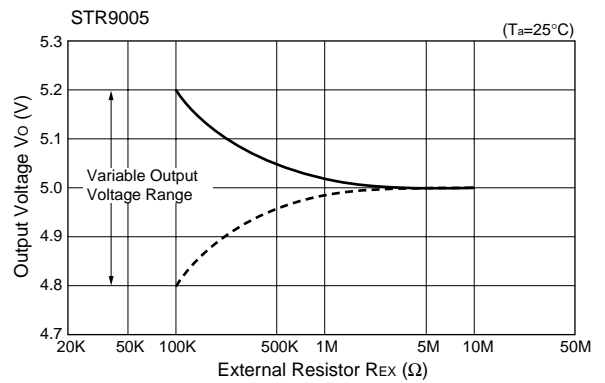

— : Insertion of resistor between terminals No. 2 and No. 5
 - - - : Insertion of resistor between terminals No. 2 and No. 1

② Typical Characteristics of Fine Output Voltage Adjustment

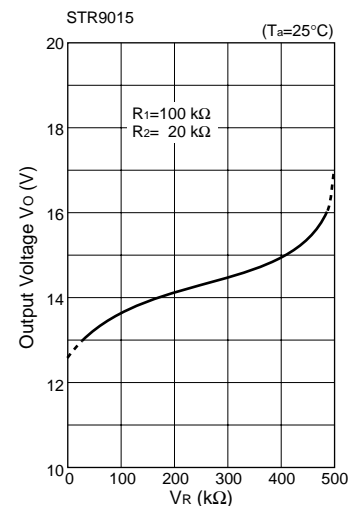
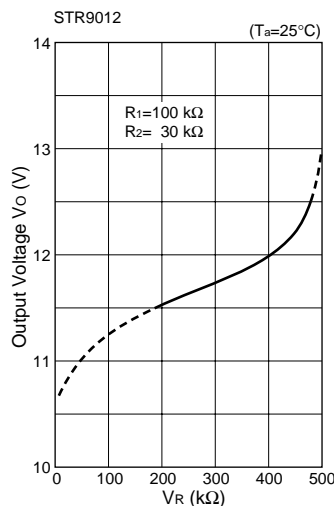
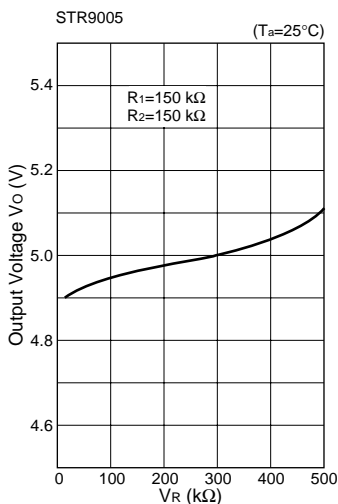

Typical Characteristics

($T_a=25^{\circ}\text{C}$)

I_o vs. V_{DIF} Characteristics

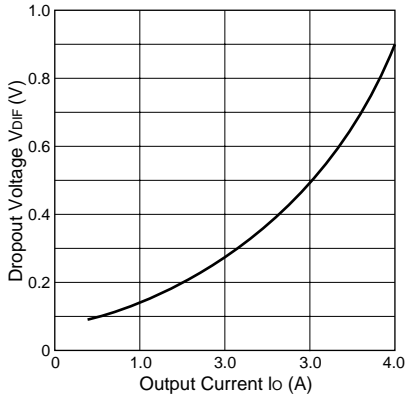

Temperature Coefficient of Output Voltage(STR9005)

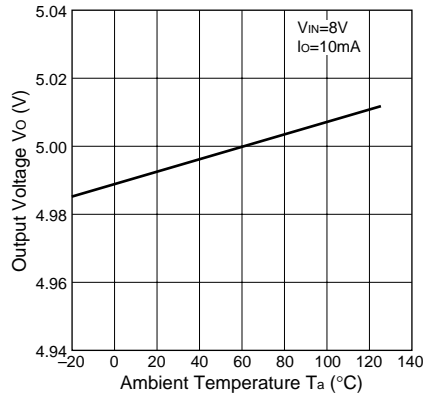

Circuit Current(STR9005)

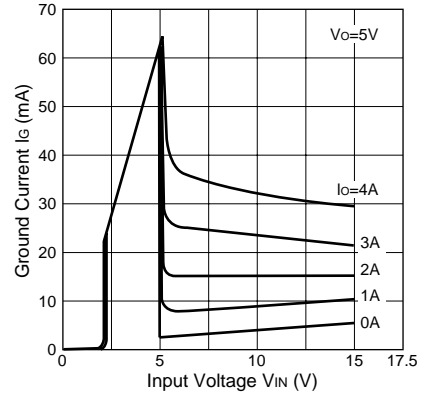

Rise Characteristics(STR9005)

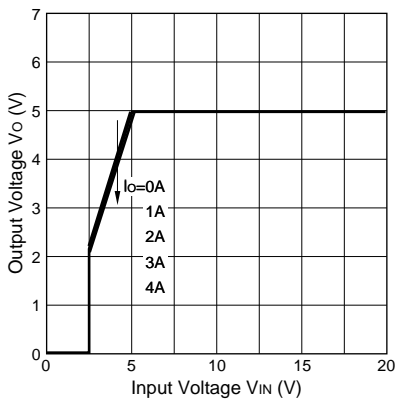

Rise Characteristics(STR9012)

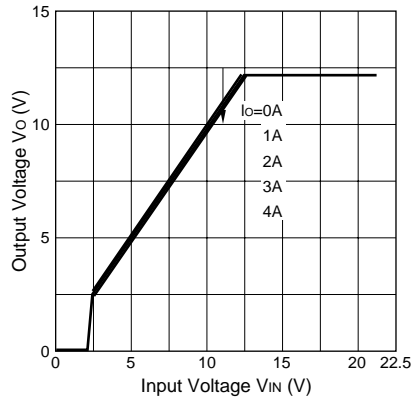

Rise Characteristics(STR9015)

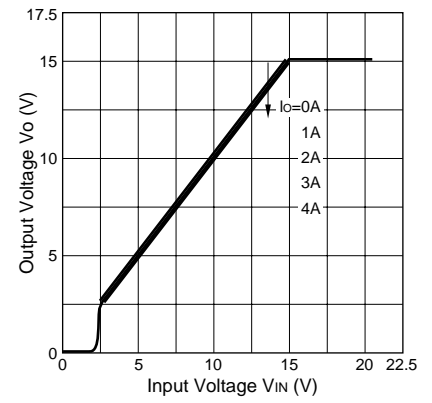

Overcurrent Protection Characteristics(STR9005)

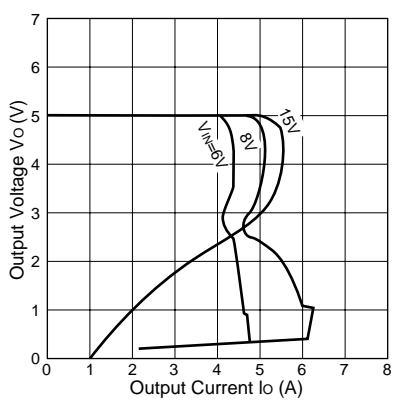

Overcurrent Protection Characteristics(STR9012)

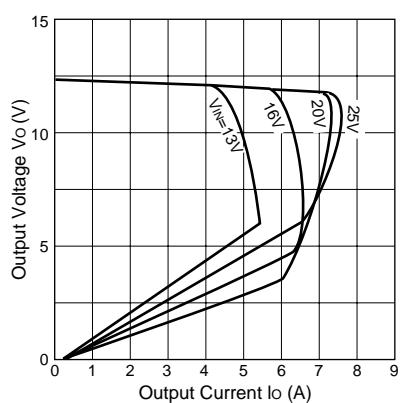

Overcurrent Protection Characteristics(STR9015)

