

FEATURES

Technology: high performance SiGe
Bandwidth: 9 GHz
Input noise current density: 1.0 μA
Optical sensitivity: -19.3 dBm
Differential transimpedance: 5000 V/A
Power dissipation: 200 mW
Input current overload: 2.8 mA p-p
Linear input range: 0.15 mA p-p
Output resistance: 50 Ω /side
Output offset adjustment range: 240 mV
Average input power monitor: 1 V/mA
Die size: 0.87 mm \times 1.06 mm

APPLICATIONS

10.7 Gbps optical modules
 SONET/SDH OC-192/STM-64 and 10 GbE
 receivers, transceivers, and transponders

PRODUCT DESCRIPTION

The ADN2820 is a compact, high performance, 3.3 V power supply SiGe transimpedance amplifier (TIA) optimized for 10 Gbps Metro-Access and Ethernet systems. It is a single chip solution for detecting photodiode current with a differential output voltage. The ADN2820 features low input referred noise current and high output transimpedance gain, capable of driving a typical CDR or transceiver directly. A POWMON output is provided for input average power monitoring and alarm generation. Low nominal output offset enables dc output coupling to 3.3 V circuits. The OFFSET control input enables output slice level adjustment for asymmetric input signals. The ADN2820 operates with a 3.3 V power supply and is available in die form.

FUNCTIONAL BLOCK DIAGRAM

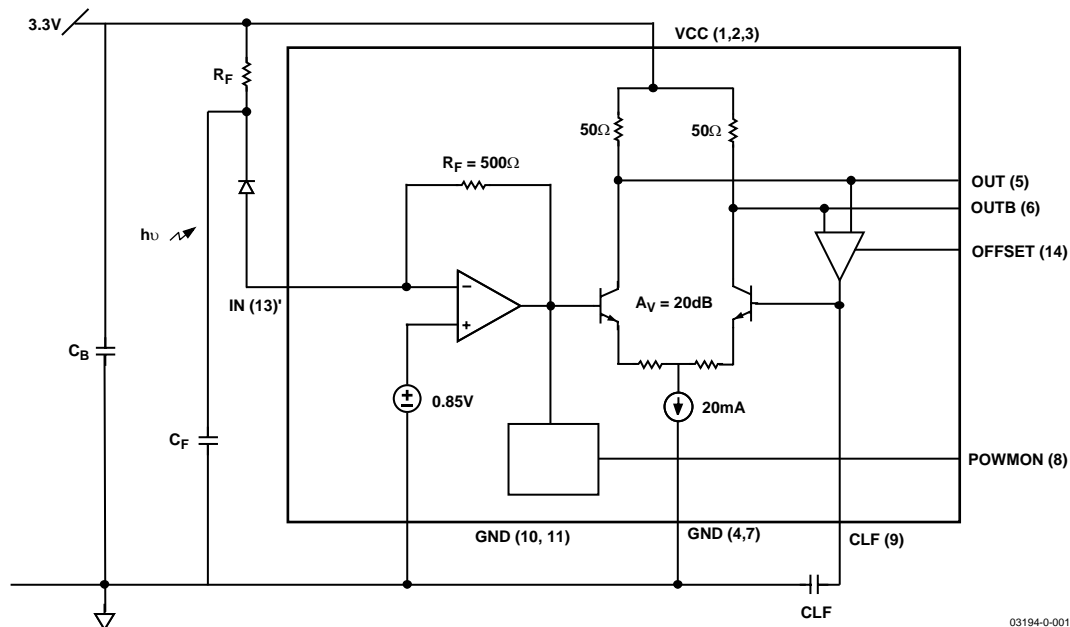

Figure 1. Functional Block Diagram/Typical Operating Circuit

Rev. 0

Information furnished by Analog Devices is believed to be accurate and reliable. However, no responsibility is assumed by Analog Devices for its use, nor for any infringements of patents or other rights of third parties that may result from its use. Specifications subject to change without notice. No license is granted by implication or otherwise under any patent or patent rights of Analog Devices. Trademarks and registered trademarks are the property of their respective owners.

TABLE OF CONTENTS

Specifications.....	3	Applications.....	8
Absolute Maximum Ratings.....	4	Optical Sensitivity	8
ESD Caution.....	4	Optical Power Monitor	8
Pad Layout and Functional Descriptions	5	Output Offset Adjust Input	9
Pad Layout	5	Low Frequency Transimpedance Cutoff Capacitor Selection.....	9
Die Information	5	Bandwidth versus Input Bond Wire Inductance.....	10
Pad Descriptions.....	5	Bandwidth versus Output Bond Wire Inductance.....	10
Pad Coordinates	5	Butterfly Package Assembly	11
Typical Performance Characteristics	6	Outline Dimensions	12
		Ordering Guide	12

REVISION HISTORY

Revision 0: Initial Version

SPECIFICATIONS

Table 1. Electrical Specifications

Parameter	Conditions ¹	Min	Typ	Max	Unit
DYNAMIC PERFORMANCE					
Bandwidth ^{1,2}	-3 dB	7.5	9		GHz
Total Input RMS Noise ^{1,2}	DC to 10 GHz		1.0		μA
Small Signal Transimpedance	100 MHz	4000	5000	6000	V/A
Transimpedance Ripple	100 MHz to 3 GHz		±0.5		dB
Group Delay Variation	100 MHz to 3 GHz		±10		ps
	100 MHz to 9 GHz		±30		ps
Total Peak-to-Peak Jitter ^{2,3}	$I_{IN,P-P} = 2.5$ mA		17		ps
Low Frequency Cutoff	$C_{LF} = 0.1$ μF		12		kHz
S22	DC - 10 GHz, differential		-10		dB
Linear Input Range	Peak-to-peak, <1 dB compression		0.15		mA
Input Overload Current ^{1,2}	ER = 10 dB	1.4	2.8		mA p-p
	ER = 4 dB	1.0	1.9		mA p-p
Maximum Output Swing	Differential, $I_{IN,P-P} = 2.0$ mA	0.88	1.1		V p-p
DC PERFORMANCE					
Power Dissipation		147	200	264	mW
Input Voltage		0.75	0.85	0.93	V
Output Common-Mode Voltage	DC terminated to V_{CC}		$V_{CC} - 0.3$		V
Output Offset	$I_{IN,AVE} < 0.1$ mA	-20	±3	+20	mV
Offset Adjust Sensitivity	See Figure 3		120		mV/V
Offset Adjust Range	See Figure 3		240		mV
POWMON Sensitivity	$I_{IN,AVE} = 10$ μA to 1 mA	0.76	1	1.2	V/mA
POWMON Offset	$I_{IN,AVE} = 0$ μA		20		mV

¹ Min/Max $V_{CC} = 3.3$ V ± 0.3 V, $T_{AMBIENT} = -15^{\circ}\text{C}$ to $+85^{\circ}\text{C}$; Typ $V_{CC} = 3.3$ V, $T_{AMBIENT} = 25^{\circ}\text{C}$.

² Photodiode capacitance $C_D = 0.22$ pF ± 0.04 pF; photodiode resistance = 20 Ω; $C_B = C_F = 100$ pF; $R_F = 100$ Ω; input wire bond inductance $L_{IN} = 0.5$ nH ± 0.15 nH; output bond wire inductance $L_{OUT,OUTB} = 0.85$ nH ± 0.15 nH; load impedance = 50 Ω (each output, dc- or ac-coupled).

³ 10^{-12} BER, 8 dB extinction ratio, 0.85 A/W PIN responsivity.

ADN2820

ABSOLUTE MAXIMUM RATINGS

Table 2. ADN2820 Absolute Maximum Ratings

Parameter	Rating
Supply Voltage (V_{CC} to GND)	5.2 V
Internal Power Dissipation	
Output Short Circuit Duration	Indefinite
Maximum Input Current	5 mA
Storage Temperature Range	-65°C to +125°C
Operating Ambient Temperature Range	-15°C to +85°C
Maximum Junction Temperature	165°C
Die Attach Temperature (<60 seconds)	450°C

Stresses above those listed under Absolute Maximum Ratings may cause permanent damage to the device. This is a stress rating only; functional operation of the device at these or any other conditions above those indicated in the operational section of this specification is not implied. Exposure to absolute maximum rating conditions for extended periods may affect device reliability.

ESD CAUTION

ESD (electrostatic discharge) sensitive device. Electrostatic charges as high as 4000 V readily accumulate on the human body and test equipment and can discharge without detection. Although this product features proprietary ESD protection circuitry, permanent damage may occur on devices subjected to high energy electrostatic discharges. Therefore, proper ESD precautions are recommended to avoid performance degradation or loss of functionality.



PAD LAYOUT AND FUNCTIONAL DESCRIPTIONS

PAD LAYOUT

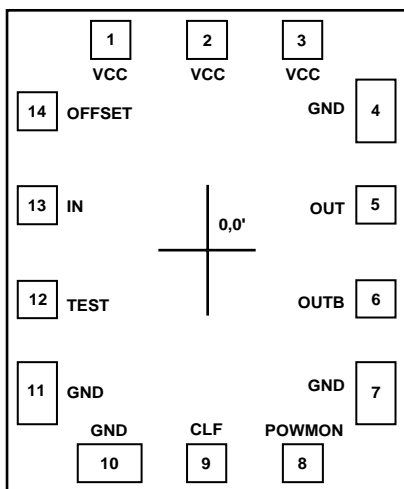

03194-0-002

Figure 2. ADN2820 Pad Layout

DIE INFORMATION

Die Size

0.875 mm × 1.060 mm

Die Thickness

12 mils = 0.3 mm

Passivation Openings

0.08 mm × 0.08 mm

0.12 mm × 0.08 mm

0.08 mm × 0.12 mm

Passivation Composition

5000 Å Si₃N₄ (Top)+5000 Å SiO₂ (Bottom)

Pad Composition

Al/1% Cu

Backside Contact

P-Type Handle (Oxide Isolated from Active Circuitry)

PAD DESCRIPTIONS

Table 3. Pad Descriptions

Pin No.	Pad	Function
1–3	VCC	Positive Supply. Bypass to GND with a 100 pF or greater single-layer capacitor.
4, 7, 10, 11	GND	Ground.
5	OUT	Positive Output. Drives 50 Ω termination (ac or dc termination).
6	OUTB	Negative Output. Drives 50 Ω termination (ac or dc termination).
8	POWMON	Input Average Power Monitor. Analog signal proportional to average optical input power. Leave open if unused.
9	CLF	Low Frequency Cutoff Setpoint. Connect with a 0.1 μF capacitor to GND for 20 kHz.
12	TEST	Test Pad. Leave Floating.
13	IN	Current Input. Bond directly to reverse biased PIN or APD anode. Filter PIN or APD anode with 100 pF × 100 Ω or greater.
14	OFFSET	Output Offset Adjust Input. Leave open if not being used and the input slice threshold will automatically be set to the eye center.

PAD COORDINATES

Table 4. Pad Coordinates

Pin No.	PAD	X (mm)	Y (mm)
1	VCC	-0.20	0.45
2	VCC	0.00	0.45
3	VCC	0.20	0.45
4	GND	0.35	0.30
5	OUT	0.35	0.10
6	OUTB	0.35	-0.10
7	GND	0.35	-0.30

Pin No.	PAD	X (mm)	Y (mm)
8	POWMON	0.20	-0.45
9	CLF	0.00	-0.45
10	GND	-0.20	-0.45
11	GND	-0.35	-0.30
12	TEST	-0.35	-0.10
13	IN	-0.35	0.10
14	OFFSET	-0.35	0.30

TYPICAL PERFORMANCE CHARACTERISTICS

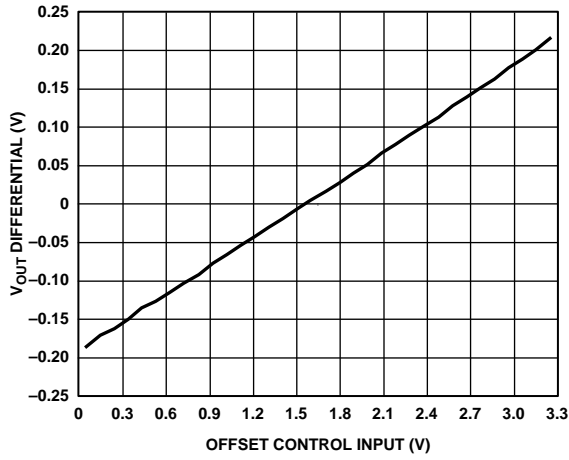

Figure 3. V_{OUT} Differential vs. OFFSET Adjust

03194-0-008

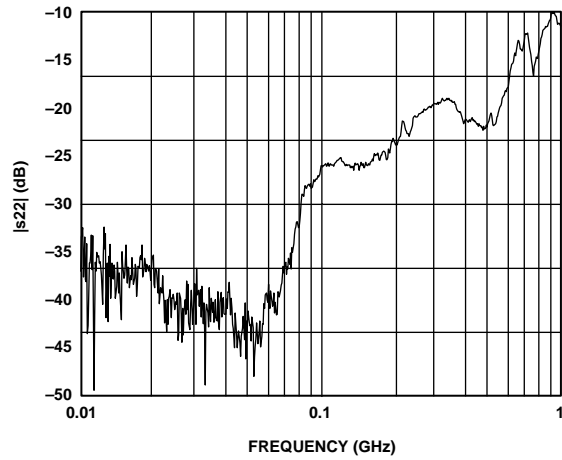

Figure 6. Differential S22 vs. Frequency

03194-0-011

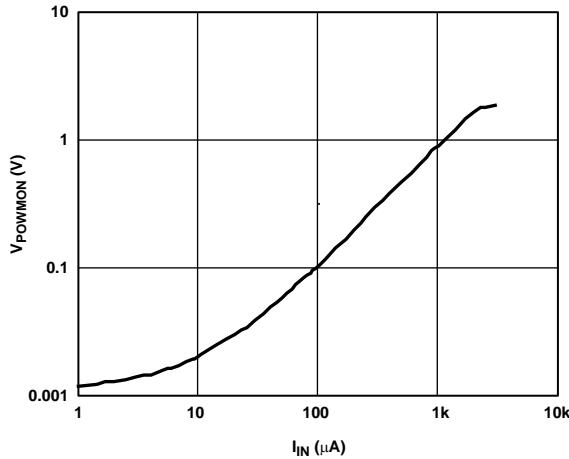

Figure 4. V_{POWMON} vs. I_{IN}

03194-0-009

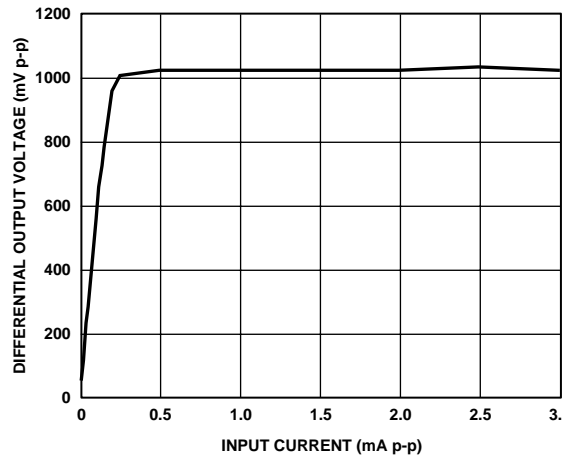

Figure 7. Output Voltage vs. Input Current

03194-0-012

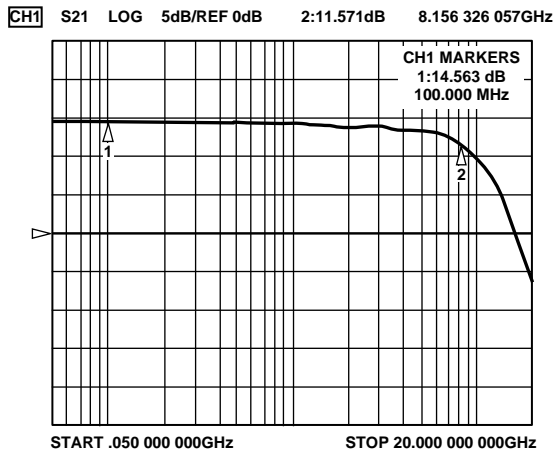

Figure 5. ADN2820 S21

03194-0-010

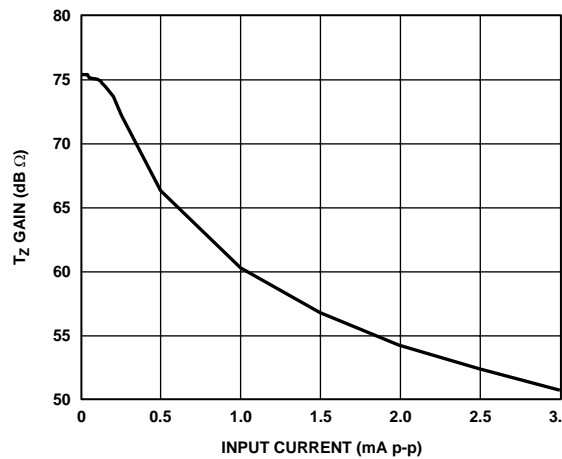
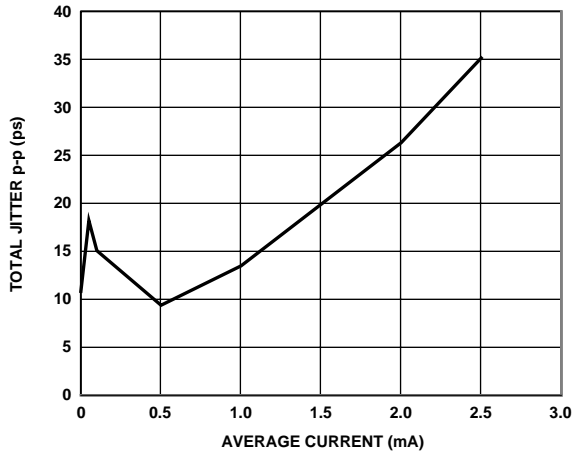

Figure 8. Transimpedance Gain vs. Input Current

03194-0-013



03194-0-014

Figure 9. Total Jitter Peak-to-Peak vs. Average Input Current ($I_{IN} = 2 \text{ mA p-p}$)

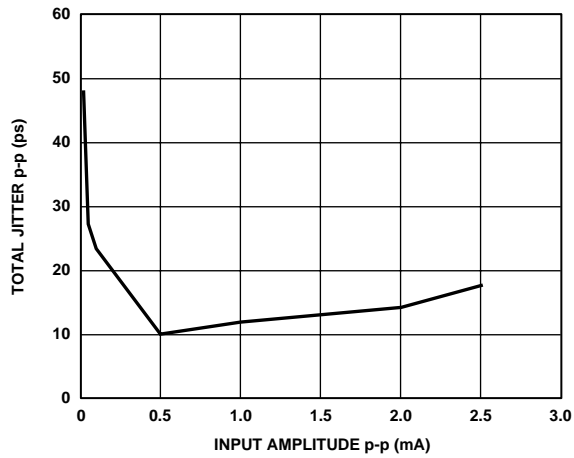

03194-0-015

Figure 10. Total Jitter Peak-to-Peak vs. Input Amplitude ($ER = 10 \text{ dB}$)

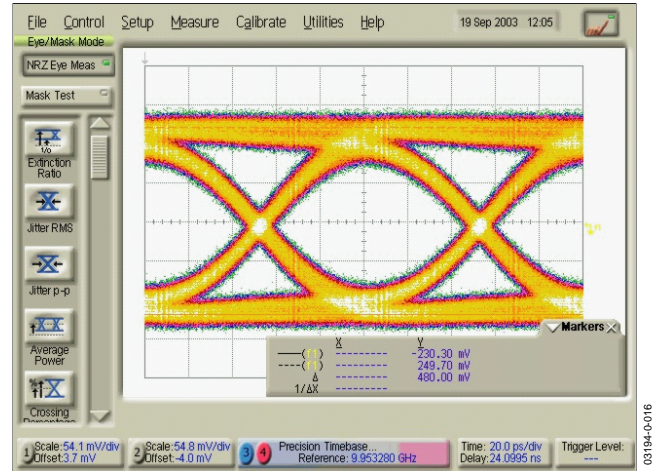

03194-0-016

Figure 11. Electrical Eye Diagram at 10 Gbps, PRBS 2^{31} with $I_{IN} = 100 \mu\text{A p-p}$

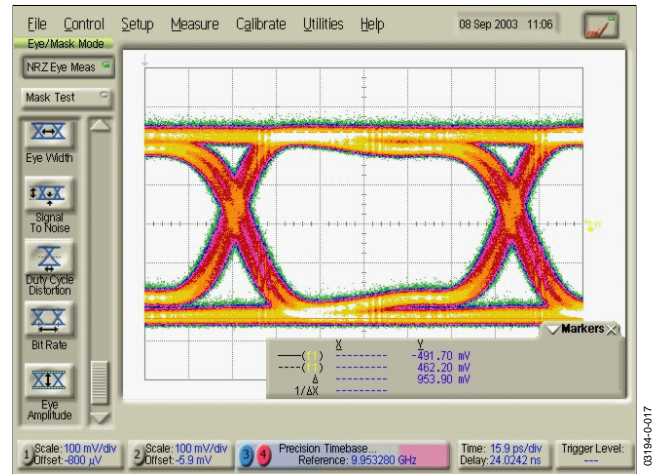

03194-0-017

Figure 12. Electrical Eye Diagram at 10 Gbps, PRBS 2^{31} with $I_{IN} = 2.5 \text{ mA p-p}$

APPLICATIONS

OPTICAL SENSITIVITY

$$Sensitivity(dBm) = 10 \log_{10} \frac{(I_{RMS} \times \alpha + V_S / Z_T) \times (ER + 1) \times (1000mW / W)}{2\rho(ER - 1)}$$

where:

- ρ = photodiode responsivity (A/W), 0.85 A/W typical
- I_{RMS} = TIA input referred noise (A), typically 1.05 μ A for the ADN2820
- α = BER factor, $\alpha = 14.1$ for 10–12 BER
- ER = extinction ratio, 8 dB typical
- V_S = PA/CDR input sensitivity (V), 5 mV to 100 mV
- Z_T = TIA transimpedance (V/A), 5 k Ω for ADN2820

Table 5. Optical Sensitivity

Optical Input Sensitivity (dBm)		Transimpedance (Z _T)		
		2 k Ω	5 k Ω	Infinite
PA/CDR Input Sensitivity (V_S)	100 mV	-13.1	-15.7	-19.3
	50 mV	-15.1	-17.1	-19.3
	25 mV	-16.7	-18.1	-19.3
	10 mV	-18.1	-18.8	-19.3
	5 mV	-18.7	-19.0	-19.3

OPTICAL POWER MONITOR

Average optical power monitor (OPM) measurement is a recommended diagnostic feature in module multisource specification agreements (MSAs) such as the 300-pin 10 Gb transponder (MSA300) and 10 Gb form factor pluggable module (XFP) specifications.

The ADN2820 enables the simple calculation of OPM using the POWMON output, which is linearly proportional to the average input current. When monitoring the POWMON output, connect to a high impedance input; typical POWMON output impedance is 1 k Ω . To disable the POWMON feature, leave the pad floating (not bonded).

Assuming linear diode responsivity ρ , average input current is linearly proportional to average input power:

$$I_{IN,AVE} (A) = \rho (A/W) \times P_{IN,AVE} (W)$$

Ideally,

$$POWMON (V) = \rho (A/W) \times P_{IN,AVE} (W) \times POWMON_{GAIN} (V/A) + POWMON_{OFFSET} (V)$$

From a POWMON measurement, the average input power can be estimated by calculating the optical power monitor (OPM):

$$OPM (W) = (POWMON (V) - POWMON_{OFFSET} (V)) / (\rho (A/W) \times POWMON_{GAIN} (V/A))$$

OPM calculation from typical ADN2820 POWMON versus $I_{IN,AVE}$ measurement data:

($POWMON_{OFFSET} = 20$ mV, $POWMON_{GAIN} = 1$ V/mA, $\rho = 1$ A/W)

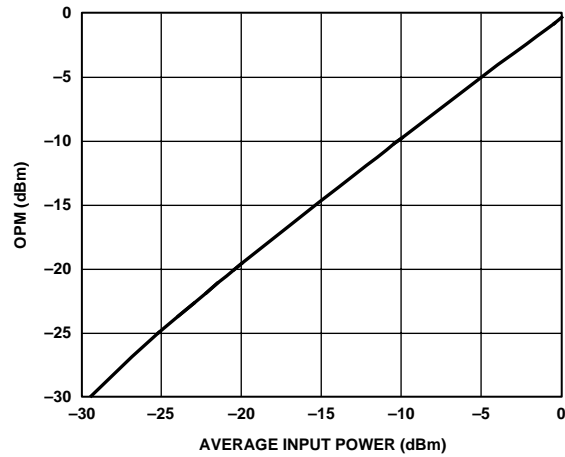

Figure 13. POWMON Transfer Function

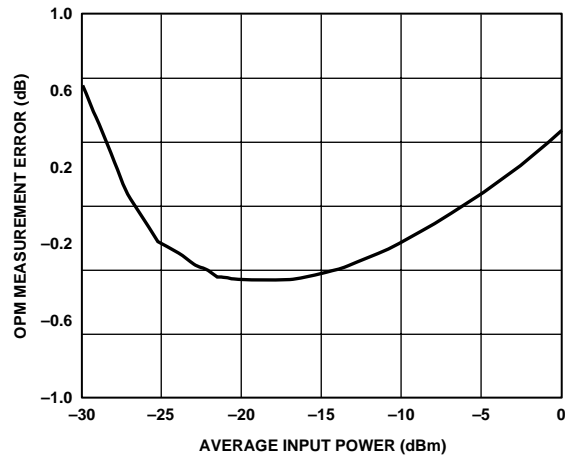

Figure 14. POWMON Accuracy

OUTPUT OFFSET ADJUST INPUT

Long reach optical links may suffer from unbalanced 1 and 0 signal shaping due to dispersion and/or optical or avalanche amplification noise. The ADN2820 enables the user to adjust the input-referred slice level by adjusting the output offset with the ADN2820's outputs dc-coupled.

With the OFFSET pad open (not bonded), the average output voltage offset [OUT – OUTB] is internally balanced to be less than ±5 mV. When externally driven by a voltage source, the ADN2820 average output voltage offset [OUT – OUTB] is linearly proportional to an applied OFFSET input voltage:

$$\text{Applied Offset (V)} = (\text{OFFSET (V)} - \sim 1.6 \text{ V}) \times \text{OFFSET}_{\text{GAIN}} \text{ (mV/V)}$$

where:

OFFSET = voltage applied to the OFFSET pad

$$\text{OFFSET}_{\text{GAIN}} = 120 \text{ mV/V}$$

With transimpedance, T_Z, the input referred slice adjust can be calculated from the following equation:

$$\text{Input Slice Adjust} = 1/T_Z \times (\text{OFFSET (V)} - \sim 1.6 \text{ V}) \times \text{OFFSET}_{\text{GAIN}} \text{ (mV/V)}$$

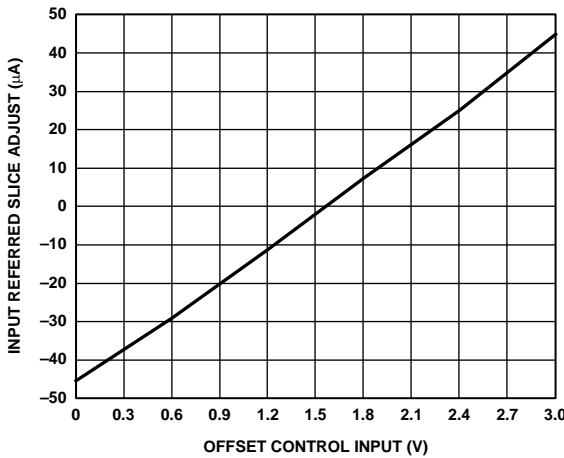

Figure 15. Input Slice Adjust vs. OFFSET Calculation Using Typical [OUT,OUTB] vs. OFFSET Measurement Data

LOW FREQUENCY TRANSIMPEDANCE CUTOFF CAPACITOR SELECTION

Digital encoding methods may generate long strings of 1s or 0s, requiring the transimpedance amplifier pass band to extend to 1 MHz or below. To accommodate this requirement, the ADN2820 has –3 dB low frequency transimpedance cutoff set by external capacitor C_{LF}. For C_{LF}, values greater than 1000 pF, the typical –3 dB low frequency transimpedance cutoff can be estimated by the equation

$$f_{-3dB} \sim 2 \text{ kHz} \times (1 \mu\text{F}/C_{LF})$$

Because C_{LF} is not part of the 10 Gbps signal chain, it is not required to be a high frequency capacitor type. A ceramic capacitor is recommended.

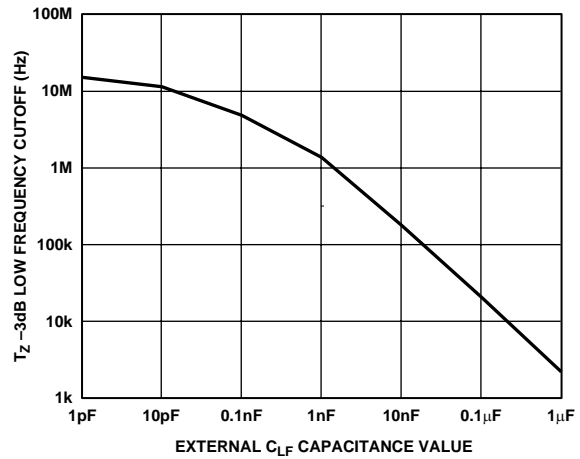

Figure 16. Low Frequency Transimpedance Cutoff vs. C_{LF} Capacitance Using Typical Data with a 0.1 µF Ceramic Capacitor and Simulation Results with 1 pF to 1 µF Capacitance

ADN2820

BANDWIDTH VERSUS INPUT BOND WIRE INDUCTANCE

The ADN2820's -3 dB bandwidth (BW) is a strong function of input (IN) bond wire inductance (L_{IN}). The maximum BW peaks near and falls rapidly after the resonant frequency of the input bond wire inductance and photodiode capacitance (C_D) $\sim 1/(2\pi \times \sqrt{L_{IN} \times C_D})$.

Table 6. Simulated ADN2820 -3 dB BW vs. L_{IN}

L_{IN} (nH)	-3 dB Bandwidth (GHz)
0	7.4
1	9.0
2	7.8
3	7.0

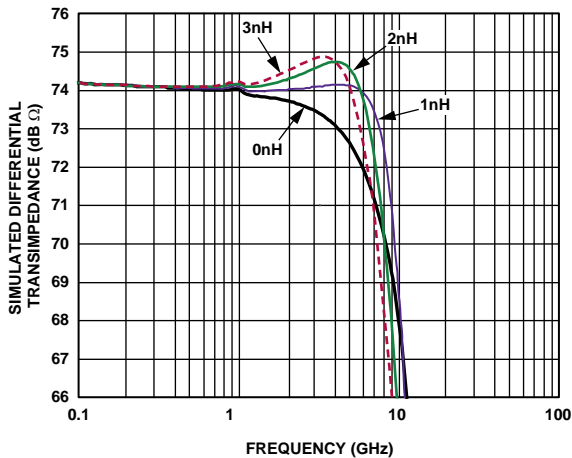

Figure 17. Simulated Differential Transimpedance (dB) vs. Frequency (Hz) with 0 nH, 1 nH, 2 nH, and 3 nH L_{IN} Inductance

Note: $L_{OUT}, L_{OUTB} = 1$ nH, $C_D = 0.22$ pF.

Recommendation: $L_{IN} \times C_D = 1$ nH \times 0.22 pF.

BANDWIDTH VERSUS OUTPUT BOND WIRE INDUCTANCE

The ADN2820 -3 dB bandwidth (BW) depends strongly on the output (OUT, OUTB) inductance values (L_{OUT}, L_{OUTB}). With output inductance greater than 2 nH, the BW is dominated by the output $L_{OUT}, L_{OUTB}/(R_O + R_L)$ settling time constant, where $R_O = R_L = 50 \Omega$ are the nominal single-ended output resistance and load impedance.

Table 7. Simulated ADN2820 -3 dB BW vs L_{OUT}, L_{OUTB}

L_{OUT}, L_{OUTB} (nH)	-3 dB Bandwidth (GHz)
0	9.1
1	9.0
2	7.5
3	5.9

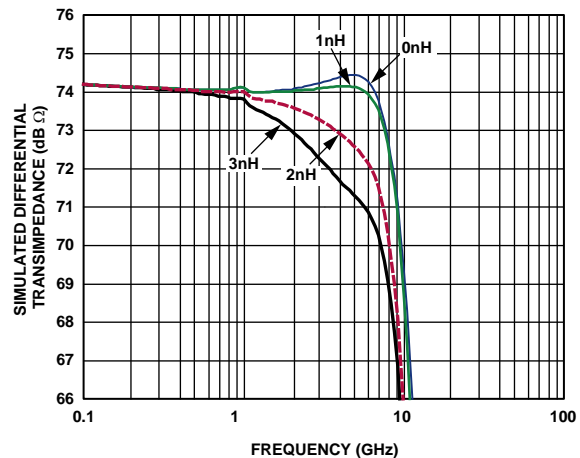

Figure 18. Simulated Differential Transimpedance (dB) vs. Frequency (Hz) with 0 nH, 1 nH, 2 nH, and 3 nH L_{OUT}, L_{OUTB} Inductance

Note: $L_{IN} = 1$ nH, $C_D = 0.22$ pF.

Recommendation: $L_{OUT}, L_{OUTB} \leq 1$ nH

BUTTERFLY PACKAGE ASSEMBLY

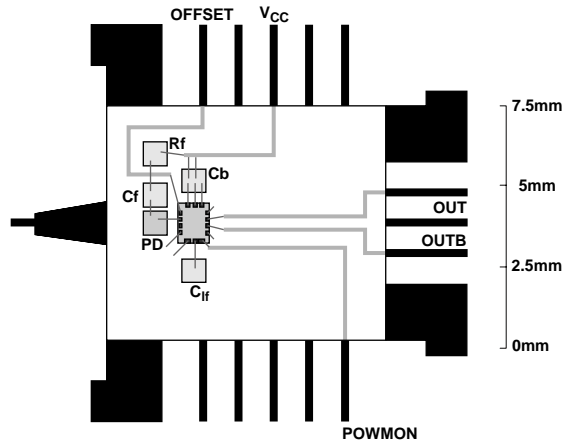

Figure 19. Butterfly Package

Table 8. Bill of Materials

	Qty.	Description	Source
PD	1	VENDOR SPECIFIC (0.5 mm × 0.5 mm)	10 Gbps Photodiode
TIA	1	ADN2820 (0.87 mm × 1.06 mm)	Analog Devices SiGe 10 Gbps Transimpedance Amplifier
C _B	2	GM250X7R10216 (0.5 mm × 0.5 mm)	Murata 1000 pF Ceramic Single Layer Capacitor
C _{LF}	1	GM260Y5V104Z10 (0.8 mm × 0.8 mm)	Murata 0.1 μF Ceramic Single Layer Capacitor
C _F	1	D20BV201J5PX (0.5 mm × 0.5 mm)	DiLabs 100 pF RF Single Layer Capacitor
RF	1	WMIF0021000AJ (0.4 mm × 0.5 mm)	Vishay 100 Ω Thin Film Microwave Resistor

ADN2820

OUTLINE DIMENSIONS

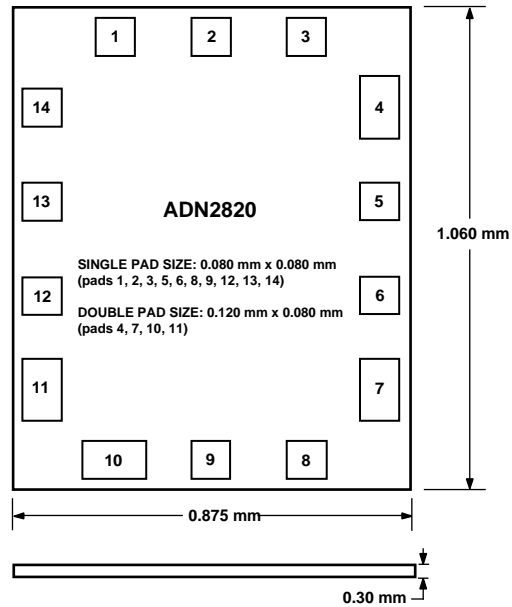

Figure 20. 14-Pad Bare Die
Dimensions shown in millimeters

ORDERING GUIDE

Model	Temperature Range	Package Description
ADN2820ACHIPS	-25°C to +85°C	Die Form