

Features

- For surface mounted applications
- High temperature metallurgically bonded-no compression contacts as found in other diode-constructed rectifiers
- Built-in strain relief
- Easy pick and place
- Plastic package has Underwriters Laboratory Flammability Classification 94V-0
- Complete device submersible temperature of 260°C for 10 seconds in solder bath

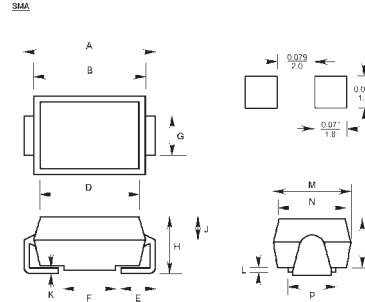

Mechanical Data

- **Case:** SMA molded plastic
- **Terminals:** Solder plated solderable per MIL-STD-750, method 2026
- **Polarity:** Indicated by cathode band
- **Weight:** 0.004 ounce, 0.115 gram

DIM	DIMENSIONS				Note
	Inches		mm		
	Min.	Max.	Min.	Max.	
A	0.216	0.226	5.48	5.74	
B	0.176	0.182	4.48	4.63	
C	0.094	0.100	2.40	2.55	
D	0.170	0.176	4.33	4.48	
E	0.039	0.055	1.00	1.40	
F	0.080	0.081	2.03	2.07	
G	0.068	0.083	1.72	2.10	
H	0.112	0.118	2.85	3.00	
J	0.057	-	1.44	-	
K	-	0.018	-	0.45	
L	0.016	-	0.40	-	
M	0.109	0.115	2.77	2.93	
N	0.105	0.107	2.67	2.73	
P	0.078	0.081	2.00	2.05	

Maximum Ratings and Electrical Characteristics

Ratings at 25°C ambient temperature unless otherwise specified.

Single phase, half wave, 60Hz, resistive or inductive load.

For capacitive load, derate current by 20%.

	Symbols	SNOA	SNOB	SNOD	SNOE	SNOG	SNOH	SNOJ	SNOK	SNOM	Units
Maximum repetitive peak reverse voltage	V_{RRM}	50	100	200	300	400	500	600	800	1000	Volts
Maximum RMS voltage	V_{RMS}	35	70	140	210	280	350	420	560	700	Volts
Maximum DC blocking voltage	V_{DC}	50	100	200	300	400	500	600	800	1000	Volts
Maximum average forward rectified current at $T_c=110^\circ\text{C}$	$I_{(AV)}$	1.5									Amps
Peak forward surge current 8.3ms single half sine-wave superimposed on rated load (MIL-STD-750D 4066 method)	I_{FSM}	60.0									Amps
Maximum instantaneous forward voltage at 1.5A	V_F	1.10									Volts
Maximum DC reverse current at rated DC blocking voltage $T_c=25^\circ\text{C}$ $T_A=125^\circ\text{C}$	I_R	5.0 200.0									μA
Maximum reverse recovery time (Note 1)	T_{rr}	2.0									μs
Typical junction capacitance (Note 2)	C_J	30.0									μF
Maximum thermal resistance (Note 3)	$R_{\theta JL}$	16.0									$^\circ\text{C/W}$
Operating and storage temperature range	T_J, T_{STG}	-55 to +150									$^\circ\text{C}$

Notes:

- (1) Reverse recovery test conditions: $I_F=0.5\text{A}$, $I_R=1.0\text{A}$, $I_{rr}=0.25\text{A}$
- (2) Measured at 1.0MHz and applied $V_r=4.0$ volts
- (3) 8.0mm² (0.013mm thick) land areas

RATINGS AND CHARACTERISTIC CURVES

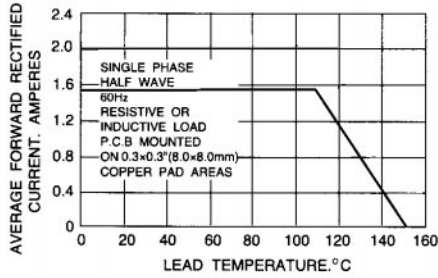

FIG. 1 - FORWARD CURRENT DERATING CURVE

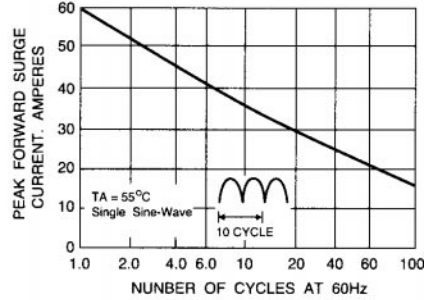

FIG. 2 - MAXIMUM NON REPETITIVE PEAK FORWARD SURGE CURRENT

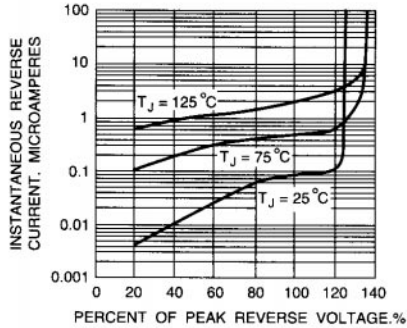

FIG. 3 - TYPICAL REVERSE CHARACTERISTICS

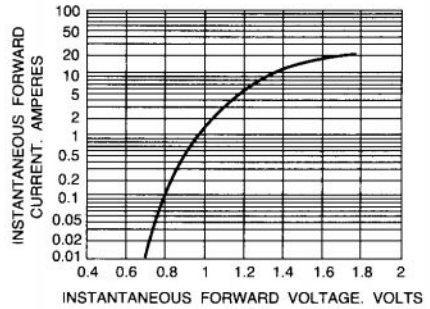

FIG. 4 - TYPICAL INSTANTANEOUS FORWARD CHARACTERISTICS

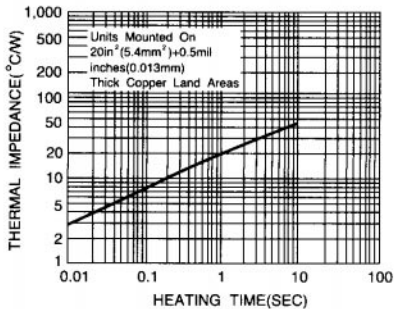

FIG. 5 - TRANSIENT THERMAL IMPEDANCE

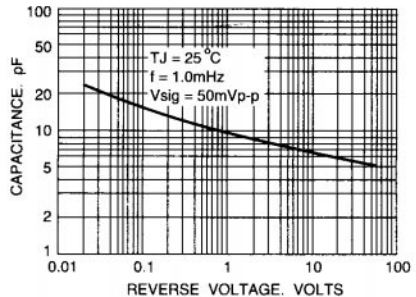

FIG. 6 - TYPICAL JUNCTION CAPACITANCE