

NEC

User's Manual

78K/0 Series

Instructions

Common to 78K/0 Series

Document No. U12326EJ4V0UM00 (4th edition)
Date Published October 2001 N CP(K)

© NEC Corporation 1995
Printed in Japan

[MEMO]

NOTES FOR CMOS DEVICES

① PRECAUTION AGAINST ESD FOR SEMICONDUCTORS

Note:

Strong electric field, when exposed to a MOS device, can cause destruction of the gate oxide and ultimately degrade the device operation. Steps must be taken to stop generation of static electricity as much as possible, and quickly dissipate it once, when it has occurred. Environmental control must be adequate. When it is dry, humidifier should be used. It is recommended to avoid using insulators that easily build static electricity. Semiconductor devices must be stored and transported in an anti-static container, static shielding bag or conductive material. All test and measurement tools including work bench and floor should be grounded. The operator should be grounded using wrist strap. Semiconductor devices must not be touched with bare hands. Similar precautions need to be taken for PW boards with semiconductor devices on it.

② HANDLING OF UNUSED INPUT PINS FOR CMOS

Note:

No connection for CMOS device inputs can be cause of malfunction. If no connection is provided to the input pins, it is possible that an internal input level may be generated due to noise, etc., hence causing malfunction. CMOS devices behave differently than Bipolar or NMOS devices. Input levels of CMOS devices must be fixed high or low by using a pull-up or pull-down circuitry. Each unused pin should be connected to V_{DD} or GND with a resistor, if it is considered to have a possibility of being an output pin. All handling related to the unused pins must be judged device by device and related specifications governing the devices.

③ STATUS BEFORE INITIALIZATION OF MOS DEVICES

Note:

Power-on does not necessarily define initial status of MOS device. Production process of MOS does not define the initial operation status of the device. Immediately after the power source is turned ON, the devices with reset function have not yet been initialized. Hence, power-on does not guarantee out-pin levels, I/O settings or contents of registers. Device is not initialized until the reset signal is received. Reset operation must be executed immediately after power-on for devices having reset function.

IEBus is a trademark of NEC Corporation.

Caution: Purchase of NEC I²C components conveys a license under the Philips I²C Patent Rights to use these components in an I²C system, provided that the system conforms to the I²C Standard Specification as defined by Philips.

The export of these products from Japan is regulated by the Japanese government. The export of some or all of these products may be prohibited without governmental license. To export or re-export some or all of these products from a country other than Japan may also be prohibited without a license from that country. Please call an NEC sales representative.

• **The information in this document is current as of August, 2001. The information is subject to change without notice. For actual design-in, refer to the latest publications of NEC's data sheets or data books, etc., for the most up-to-date specifications of NEC semiconductor products. Not all products and/or types are available in every country. Please check with an NEC sales representative for availability and additional information.**

- No part of this document may be copied or reproduced in any form or by any means without prior written consent of NEC. NEC assumes no responsibility for any errors that may appear in this document.
- NEC does not assume any liability for infringement of patents, copyrights or other intellectual property rights of third parties by or arising from the use of NEC semiconductor products listed in this document or any other liability arising from the use of such products. No license, express, implied or otherwise, is granted under any patents, copyrights or other intellectual property rights of NEC or others.
- Descriptions of circuits, software and other related information in this document are provided for illustrative purposes in semiconductor product operation and application examples. The incorporation of these circuits, software and information in the design of customer's equipment shall be done under the full responsibility of customer. NEC assumes no responsibility for any losses incurred by customers or third parties arising from the use of these circuits, software and information.
- While NEC endeavours to enhance the quality, reliability and safety of NEC semiconductor products, customers agree and acknowledge that the possibility of defects thereof cannot be eliminated entirely. To minimize risks of damage to property or injury (including death) to persons arising from defects in NEC semiconductor products, customers must incorporate sufficient safety measures in their design, such as redundancy, fire-containment, and anti-failure features.
- NEC semiconductor products are classified into the following three quality grades:
"Standard", "Special" and "Specific". The "Specific" quality grade applies only to semiconductor products developed based on a customer-designated "quality assurance program" for a specific application. The recommended applications of a semiconductor product depend on its quality grade, as indicated below. Customers must check the quality grade of each semiconductor product before using it in a particular application.

"Standard": Computers, office equipment, communications equipment, test and measurement equipment, audio and visual equipment, home electronic appliances, machine tools, personal electronic equipment and industrial robots

"Special": Transportation equipment (automobiles, trains, ships, etc.), traffic control systems, anti-disaster systems, anti-crime systems, safety equipment and medical equipment (not specifically designed for life support)

"Specific": Aircraft, aerospace equipment, submersible repeaters, nuclear reactor control systems, life support systems and medical equipment for life support, etc.

The quality grade of NEC semiconductor products is "Standard" unless otherwise expressly specified in NEC's data sheets or data books, etc. If customers wish to use NEC semiconductor products in applications not intended by NEC, they must contact an NEC sales representative in advance to determine NEC's willingness to support a given application.

(Note)

- (1) "NEC" as used in this statement means NEC Corporation and also includes its majority-owned subsidiaries.
- (2) "NEC semiconductor products" means any semiconductor product developed or manufactured by or for NEC (as defined above).

M8E 00.4

Regional Information

Some information contained in this document may vary from country to country. Before using any NEC product in your application, please contact the NEC office in your country to obtain a list of authorized representatives and distributors. They will verify:

- Device availability
- Ordering information
- Product release schedule
- Availability of related technical literature
- Development environment specifications (for example, specifications for third-party tools and components, host computers, power plugs, AC supply voltages, and so forth)
- Network requirements

In addition, trademarks, registered trademarks, export restrictions, and other legal issues may also vary from country to country.

NEC Electronics Inc. (U.S.)
Santa Clara, California
Tel: 408-588-6000
800-366-9782
Fax: 408-588-6130
800-729-9288

NEC Electronics (Germany) GmbH
Duesseldorf, Germany
Tel: 0211-65 03 02
Fax: 0211-65 03 490

NEC Electronics (UK) Ltd.
Milton Keynes, UK
Tel: 01908-691-133
Fax: 01908-670-290

NEC Electronics Italiana s.r.l.
Milano, Italy
Tel: 02-66 75 41
Fax: 02-66 75 42 99

NEC Electronics (Germany) GmbH
Benelux Office
Eindhoven, The Netherlands
Tel: 040-2445845
Fax: 040-2444580

NEC Electronics (France) S.A.
Velizy-Villacoublay, France
Tel: 01-3067-5800
Fax: 01-3067-5899

NEC Electronics (France) S.A.
Madrid Office
Madrid, Spain
Tel: 091-504-2787
Fax: 091-504-2860

NEC Electronics (Germany) GmbH
Scandinavia Office
Taebby, Sweden
Tel: 08-63 80 820
Fax: 08-63 80 388

NEC Electronics Hong Kong Ltd.
Hong Kong
Tel: 2886-9318
Fax: 2886-9022/9044

NEC Electronics Hong Kong Ltd.
Seoul Branch
Seoul, Korea
Tel: 02-528-0303
Fax: 02-528-4411

NEC Electronics Singapore Pte. Ltd.
Novena Square, Singapore
Tel: 253-8311
Fax: 250-3583

NEC Electronics Taiwan Ltd.
Taipei, Taiwan
Tel: 02-2719-2377
Fax: 02-2719-5951

NEC do Brasil S.A.
Electron Devices Division
Guarulhos-SP, Brasil
Tel: 11-6462-6810
Fax: 11-6462-6829

J01.2

Major Revisions in This Edition

Page	Description
Throughout	Deletion of all information except for information common to the 78K/0 Series (for individual product information, refer to the user's manual of each product).

The mark ★ shows major revised points.

INTRODUCTION

Target Readers	This manual is intended for users who wish to understand the functions of 78K/0 Series products and to design and develop its application systems and programs.														
Purpose	This manual is intended to give users an understanding of the various kinds of instruction functions of 78K/0 Series products.														
Organization	This manual is broadly divided into the following sections. <ul style="list-style-type: none">• CPU functions• Instruction set• Explanation of instructions														
How to Read This Manual	<p>It is assumed that readers of this manual have general knowledge in the fields of electrical engineering, logic circuits, and microcontrollers.</p> <ul style="list-style-type: none">• To check the details of the functions of an instruction whose mnemonic is known: → Refer to APPENDICES B and C.• To check an instruction whose mnemonic is not known but whose general function is known: → Find the mnemonic in CHAPTER 4 INSTRUCTION SET and then check the detailed functions in CHAPTER 5 EXPLANATION OF INSTRUCTIONS.• To learn about the various kinds of 78K/0 Series product instructions in general: → Read this manual in the order of CONTENTS.• To learn about the hardware functions of 78K/0 Series products: → See the separate user's manuals.														
Conventions	<table><tr><td>Data significance:</td><td>Higher digits on the left and lower digits on the right</td></tr><tr><td>Note:</td><td>Footnote for item marked with Note in the text</td></tr><tr><td>Caution:</td><td>Information requiring particular attention</td></tr><tr><td>Remark:</td><td>Supplementary information</td></tr><tr><td>Numeral representation:</td><td>Binary XXXX or XXXXB</td></tr><tr><td></td><td>Decimal XXXX</td></tr><tr><td></td><td>Hexadecimal XXXXH</td></tr></table>	Data significance:	Higher digits on the left and lower digits on the right	Note:	Footnote for item marked with Note in the text	Caution:	Information requiring particular attention	Remark:	Supplementary information	Numeral representation:	Binary XXXX or XXXXB		Decimal XXXX		Hexadecimal XXXXH
Data significance:	Higher digits on the left and lower digits on the right														
Note:	Footnote for item marked with Note in the text														
Caution:	Information requiring particular attention														
Remark:	Supplementary information														
Numeral representation:	Binary XXXX or XXXXB														
	Decimal XXXX														
	Hexadecimal XXXXH														

Related Documents

The related documents indicated in this publication may include preliminary versions. However, preliminary versions are not marked as such.

★ • Documents Common to 78K/0 Series

Document Name		Document No.
User's Manual Instructions		This manual
Application Note ^{Note}	Basic I	U12704E
	Basic II	U10121E
	Basic III	U10182E

Note Some subseries may not be covered.

Caution The related documents listed above are subject to change without notice. Be sure to use the latest version of each document for designing.

CONTENTS

CHAPTER 1 MEMORY SPACE	12
1.1 Memory Spaces	12
1.2 Internal Program Memory (Internal ROM) Space	12
1.3 Vector Table Area	12
1.4 CALLT Instruction Table Area	12
1.5 CALLF Instruction Entry Area	12
1.6 Internal Data Memory (Internal RAM) Space	12
1.7 Special Function Register (SFR) Area	13
1.8 External Memory Space	13
1.9 IEBus™ Register Area	13
CHAPTER 2 REGISTERS	14
2.1 Control Registers	14
2.1.1 Program counter (PC)	14
2.1.2 Program status word (PSW)	14
2.1.3 Stack pointer (SP)	16
2.2 General-Purpose Registers	17
2.3 Special Function Registers (SFRs)	19
CHAPTER 3 ADDRESSING	20
3.1 Instruction Address Addressing	20
3.1.1 Relative addressing	20
3.1.2 Immediate addressing	21
3.1.3 Table indirect addressing	22
3.1.4 Register addressing	23
3.2 Operand Address Addressing	24
3.2.1 Implied addressing	24
3.2.2 Register addressing	25
3.2.3 Direct addressing	26
3.2.4 Short direct addressing	27
3.2.5 Special-function register (SFR) addressing	28
3.2.6 Register indirect addressing	29
3.2.7 Based addressing	30
3.2.8 Based indexed addressing	30
3.2.9 Stack addressing	31
CHAPTER 4 INSTRUCTION SET	32
4.1 Operation	32
4.1.1 Operand identifiers and description methods	32
4.1.2 Description of “operation” column	33
4.1.3 Description of “flag operation” column	33
4.1.4 Description of number of clocks	34
4.1.5 Instructions listed by addressing type	34
4.2 Instruction Codes	38
4.2.1 Description of instruction code table	38
4.2.2 Instruction code list	39

CHAPTER 5 EXPLANATION OF INSTRUCTIONS	46
5.1 8-Bit Data Transfer Instructions	48
5.2 16-Bit Data Transfer Instructions	51
5.3 8-Bit Operation Instructions	54
5.4 16-Bit Operation Instructions	63
5.5 Multiply/Divide Instructions	67
5.6 Increment/Decrement Instructions	70
5.7 Rotate Instructions	75
5.8 BCD Adjust Instructions	82
5.9 Bit Manipulation Instructions	85
5.10 Call Return Instructions	93
5.11 Stack Manipulation Instructions	101
5.12 Unconditional Branch Instruction	105
5.13 Conditional Branch Instructions	107
5.14 CPU Control Instructions	116
APPENDIX A REVISION HISTORY	123
APPENDIX B INSTRUCTION INDEX (MNEMONIC: BY FUNCTION)	124
APPENDIX C INSTRUCTION INDEX (MNEMONIC: IN ALPHABETICAL ORDER)	126

LIST OF FIGURES

Figure No.	Title	Page
2-1	Program Counter Configuration	14
2-2	Program Status Word Configuration	14
2-3	Stack Pointer Configuration	16
2-4	Data to Be Saved to Stack Memory	16
2-5	Data to Be Reset from Stack Memory	16
2-6	General-Purpose Register Configuration	18

LIST OF TABLES

Table No.	Title	Page
2-1	General-Purpose Register Absolute Address Correspondence Table	17
4-1	Operand Identifiers and Description Methods	32

CHAPTER 1 MEMORY SPACE

1.1 Memory Spaces

The 78K/0 Series product program memory map varies depending on the internal memory capacity. For details of memory-mapped address area, refer to the user's manual of each product.

1.2 Internal Program Memory (Internal ROM) Space

Each 78K/0 Series product has internal ROM in the address space. Program and table data, etc. are stored ★ in the ROM. Normally, this memory space is addressed by the program counter (PC). For details of the internal ROM space, refer to the user's manual of each product.

1.3 Vector Table Area

The 64-byte area 0000H to 003FH is reserved as a vector table area. The program start addresses for branch upon $\overline{\text{RESET}}$ input or interrupt request generation are stored in the vector table area. Of the 16-bit address, the ★ lower 8 bits are stored at even addresses and the higher 8 bits are stored at odd addresses. For the vector table area, refer to the user's manual of each product.

1.4 CALLT Instruction Table Area

The 64-byte area 0040H to 007FH can store the subroutine entry address of a 1-byte call instruction (CALLT).

1.5 CALLF Instruction Entry Area

The 2048-byte area 0800H to 0FFFH can perform a direct subroutine call with a 2-byte call instruction (CALLF).

1.6 Internal Data Memory (Internal RAM) Space

★ 78K/0 Series products incorporate the following RAMs. For details of these RAMs, refer to the user's manual of each product.

(1) Internal high-speed RAM

Each 78K/0 Series product incorporates an internal high-speed RAM. In the 32-byte area FEE0H to FEFFH of these areas, 4 banks of general-purpose registers, each bank consisting of eight 8-bit registers, are allocated.

The internal high-speed RAM can also be used as a stack memory.

(2) Buffer RAM

★ There are some products in the 78K/0 Series to which buffer RAM is allocated. This RAM is used to store the transfer/receive data of serial interface channel 1 (3-wire serial I/O mode with automatic transfer/receive function). If not used in this mode, the buffer RAM can also be used as an ordinary RAM area.

(3) RAM for VFD display

- ★ There are some products in the 78K/0 Series to which RAM for VFD display is allocated. This RAM can also be used as an ordinary RAM area.

(4) Internal expansion RAM

- ★ There are some products in the 78K/0 Series to which internal expansion RAM is allocated.

(5) RAM for LCD display

- ★ There are some products in the 78K/0 Series to which RAM for LCD display is allocated. This RAM can also be used as an ordinary RAM area.

1.7 Special Function Register (SFR) Area

- ★ On-chip peripheral hardware special function registers (SFRs) are allocated in the area FF00H to FFFFH (for details of the special function registers, refer to the user's manual of each product).

Caution Do not access addresses to which SFRs are not allocated. If an address is erroneously accessed, the CPU may become deadlocked.

1.8 External Memory Space

This is an external memory space that can be accessed by setting the memory extension mode register. This space can store program and table data, and be assigned peripheral devices.

- ★ For details of the products in which an external memory space can be used, refer to the user's manual of each product.

1.9 IEBus™ Register Area

- ★ IEBus registers that are used to control the IEBus controller are allocated to the IEBus register area. For details of the products that incorporate an IEBus controller, refer to the user's manual of each product.

CHAPTER 2 REGISTERS

2.1 Control Registers

The control registers control the program sequence, statuses and stack memory. A program counter, a program status word and a stack pointer are the control registers.

2.1.1 Program counter (PC)

The program counter is a 16-bit register that holds the address information of the next program to be executed.

In normal operation, the PC is automatically incremented according to the number of bytes of the instruction to be fetched. When a branch instruction is executed, immediate data and register contents are set.

$\overline{\text{RESET}}$ input sets the reset vector table values at addresses 0000H and 0001H to the program counter.

Figure 2-1. Program Counter Configuration

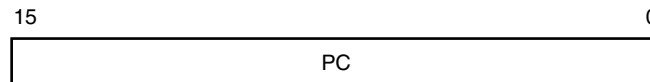

2.1.2 Program status word (PSW)

The program status word is an 8-bit register consisting of various flags to be set/reset by instruction execution.

Program status word contents are automatically stacked upon interrupt request generation or PUSH PSW instruction execution and are automatically reset upon execution of the RETB, RETI and POP PSW instructions.

$\overline{\text{RESET}}$ input sets the PSW to 02H.

Figure 2-2. Program Status Word Configuration

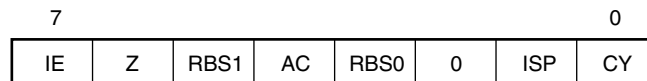

(1) Interrupt enable flag (IE)

This flag controls the interrupt request acknowledgement operations of the CPU.

When IE = 0, the IE flag is set to interrupt disable (DI), and interrupts other than non-maskable interrupts are all disabled.

When IE = 1, the IE flag is set to interrupt enable (EI), and interrupt request acknowledgement is controlled by an in-service priority flag (ISP), an interrupt mask flag for various interrupt sources, and a priority specification flag.

This flag is reset (0) upon DI instruction execution or interrupt request acknowledgment and is set (1) upon execution of the EI instruction.

(2) Zero flag (Z)

When the operation result is zero, this flag is set (1). It is reset (0) in all other cases.

(3) Register bank select flags (RBS0 and RBS1)

These are 2-bit flags used to select one of the four register banks.

In these flags, the 2-bit information that indicates the register bank selected by SBL RBn instruction execution is stored.

(4) Auxiliary carry flag (AC)

If the operation result has a carry from bit 3 or a borrow at bit 3, this flag is set (1). It is reset (0) in all other cases.

(5) In-service priority flag (ISP)

This flag manages the priority of acknowledgeable maskable vectored interrupts. When ISP = 0, vectored interrupt requests specified as low priority by the priority specification flag register (PR) are disabled for acknowledgment. Actual acknowledgment for interrupt requests is controlled by the state of the interrupt enable flag (IE).

(6) Carry flag (CY)

This flag stores an overflow or underflow upon add/subtract instruction execution. It stores the shift-out value upon rotate instruction execution and functions as a bit accumulator during bit manipulation instruction execution.

2.1.3 Stack pointer (SP)

This is a 16-bit register that holds the start address of the memory stack area. Only the internal high-speed RAM area can be set as the stack area.

Figure 2-3. Stack Pointer Configuration

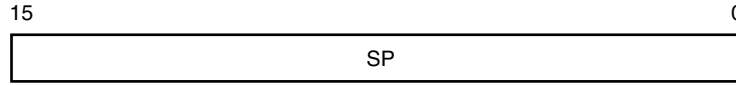

The SP is decremented ahead of write (save) to the stack memory and is incremented after read (reset) from the stack memory.

Each stack operation saves/resets data as shown in Figures 2-4 and 2-5.

Caution Since $\overline{\text{RESET}}$ input makes SP contents undefined, be sure to initialize the SP before instruction execution.

Figure 2-4. Data to Be Saved to Stack Memory

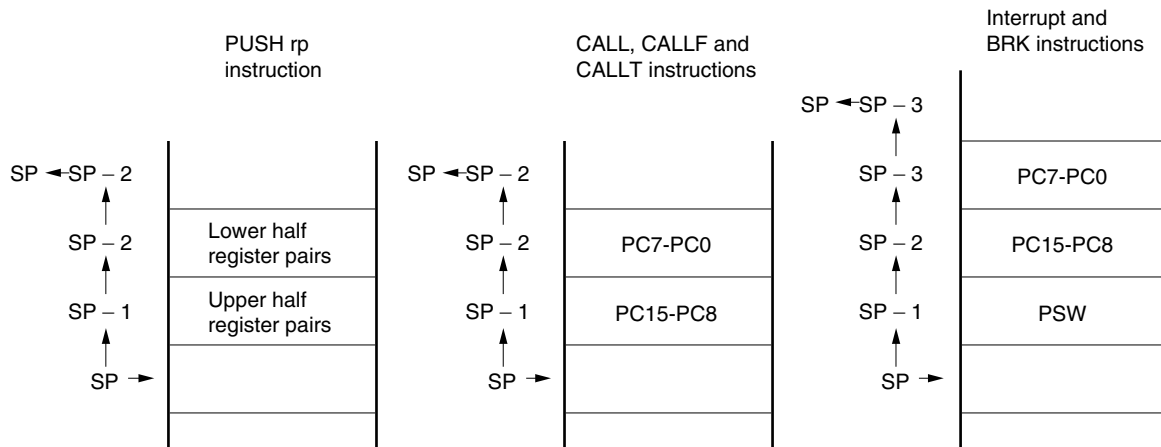
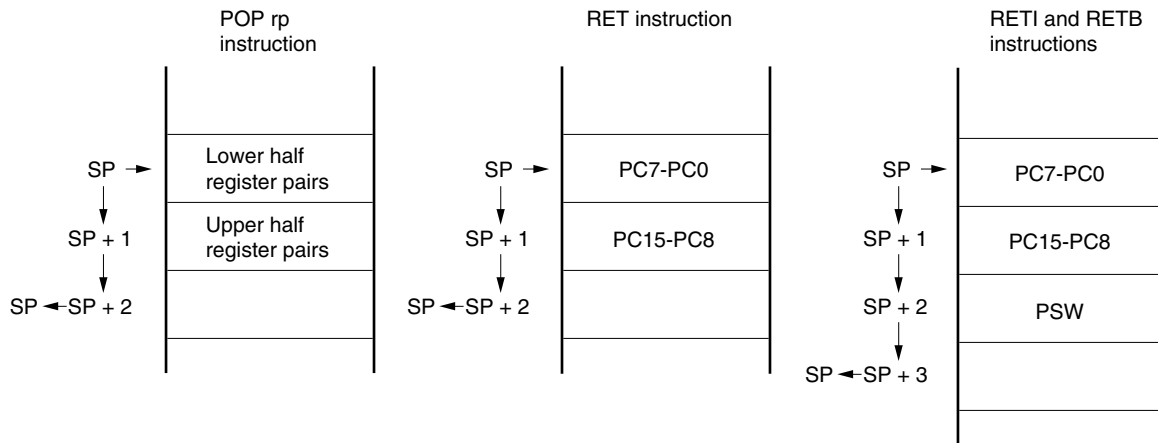

Figure 2-5. Data to Be Reset from Stack Memory



2.2 General-Purpose Registers

General-purpose registers are mapped at particular addresses (FEE0H to FEFFH) of the data memory. These registers consist of 4 banks, each bank consisting of eight 8-bit registers (X, A, C, B, E, D, L and H).

In addition that each register can be used as an 8-bit register, two 8-bit registers in pairs can be used as a 16-bit register (AX, BC, DE and HL).

General-purpose registers can be described in terms of functional names (X, A, C, B, E, D, L, H, AX, BC, DE and HL) and absolute names (R0 to R7 and RP0 to RP3).

Register banks to be used for instruction execution are set with the CPU control instruction (SEL RBn). Because of the 4-register bank configuration, an efficient program can be created by switching between a register for normal processing and a register for processing upon interrupt generation for each bank.

Table 2-1. General-Purpose Register Absolute Address Correspondence Table

Bank Name	Register		Absolute Address	Bank Name	Register		Absolute Address
	Functional Name	Absolute Name			Functional Name	Absolute Name	
BANK0	H	R7	FEFFH	BANK2	H	R7	FEEFH
	L	R6	FEFEH		L	R6	FEEEH
	D	R5	FEFDH		D	R5	FEE DH
	E	R4	FEFCH		E	R4	FEECH
	B	R3	FEFBH		B	R3	FEEBH
	C	R2	FEFAH		C	R2	FEEAH
	A	R1	FEF9H		A	R1	FEE9H
	X	R0	FEF8H		X	R0	FEE8H
BANK1	H	R7	FEF7H	BANK3	H	R7	FEE7H
	L	R6	FEF6H		L	R6	FEE6H
	D	R5	FEF5H		D	R5	FEE5H
	E	R4	FEF4H		E	R4	FEE4H
	B	R3	FEF3H		B	R3	FEE3H
	C	R2	FEF2H		C	R2	FEE2H
	A	R1	FEF1H		A	R1	FEE1H
	X	R0	FEF0H		X	R0	FEE0H

Figure 2-6. General-Purpose Register Configuration

(a) Absolute names

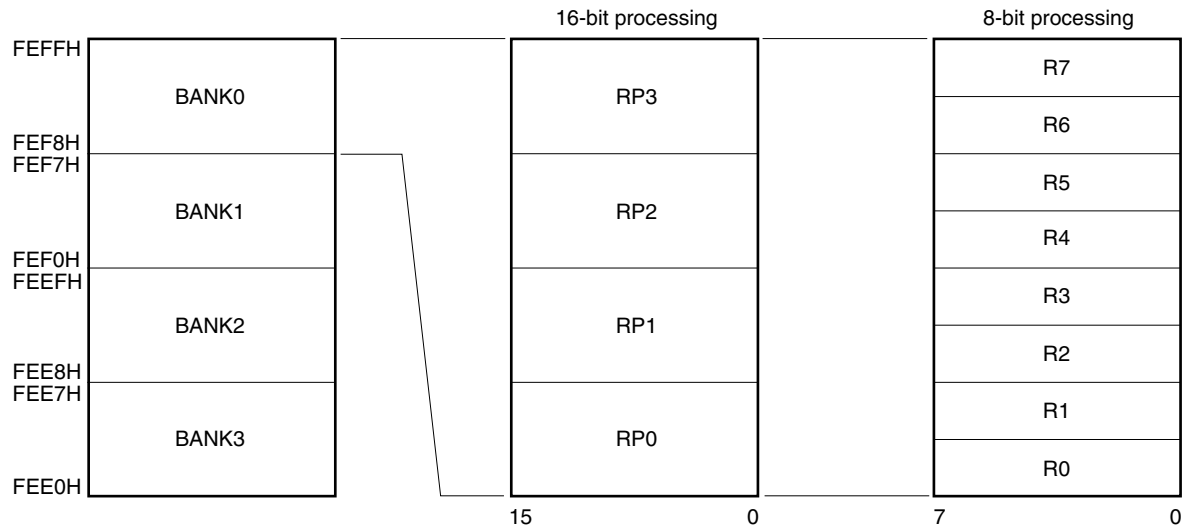

(b) Functional names

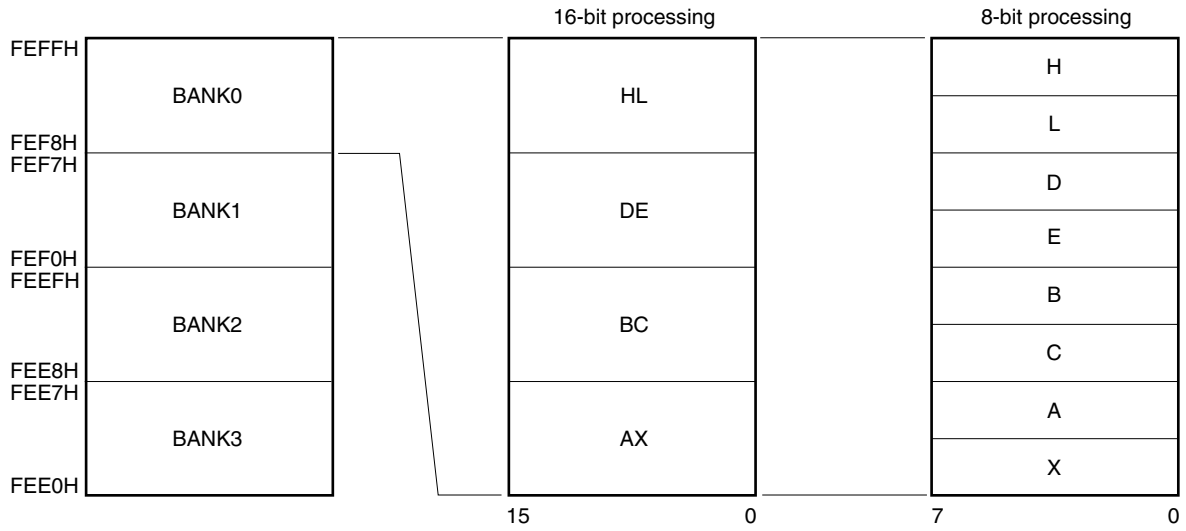

2.3 Special Function Registers (SFRs)

Unlike a general-purpose register, each special-function register has a special function.

Special function registers are allocated in the 256-byte area FF00H to FFFFH.

Special function registers can be manipulated, like general-purpose registers, by operation, transfer and bit manipulation instructions. The manipulatable bit units (1, 8, and 16) differ depending on the special function register type.

Each manipulation bit unit can be specified as follows.

- 1-bit manipulation
Describes a symbol reserved by the assembler for the 1-bit manipulation instruction operand (sfr.bit). This manipulation can also be specified by an address.
- 8-bit manipulation
Describes a symbol reserved by the assembler for the 8-bit manipulation instruction operand (sfr). This manipulation can also be specified by an address.
- 16-bit manipulation
Describes a symbol reserved by the assembler for the 16-bit manipulation instruction operand (sfrp). When addressing an address, describe an even address.

For details of the special function registers, refer to the user's manual of each product.

Caution Do not access addresses to which SFRs are not allocated. If an address is erroneously accessed, the CPU may become deadlocked.

CHAPTER 3 ADDRESSING

3.1 Instruction Address Addressing

An instruction address is determined by program counter (PC) contents. The PC contents are normally incremented (+1 for each byte) automatically according to the number of bytes of an instruction to be fetched each time another instruction is executed. When a branch instruction is executed, the branch destination information is set to the PC and branched by the following addressing (for details of each instruction, refer to **CHAPTER 5 EXPLANATION OF INSTRUCTIONS**).

3.1.1 Relative addressing

[Function]

The value obtained by adding 8-bit immediate data (displacement value: $jdisp8$) of an instruction code to the start address of the following instruction is transferred to the program counter (PC) and branched. The displacement value is treated as signed two's complement data (-128 to $+127$) and bit 7 becomes a sign bit. In other words, in relative addressing, the value is relatively transferred to the range between -128 and $+127$ from the start address of the following instruction.

This function is carried out when the "BR \$addr16" instruction or a conditional branch instruction is executed.

[Illustration]

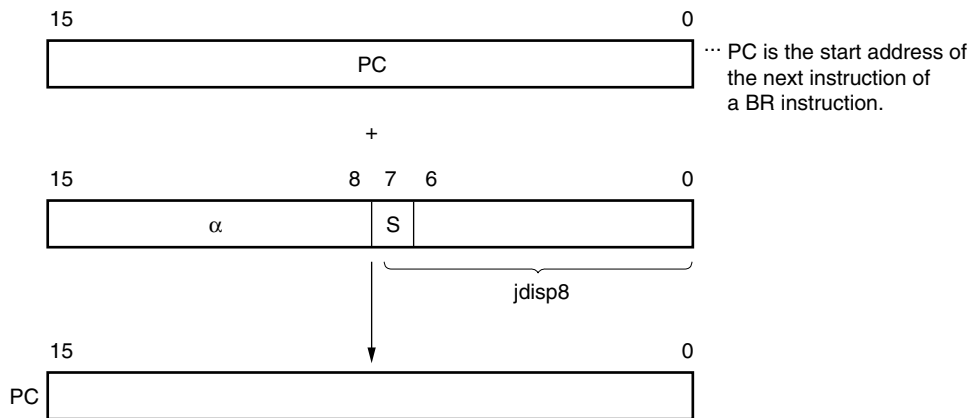

When $S = 0$, α indicates all bits "0".
When $S = 1$, α indicates all bits "1".

3.1.2 Immediate addressing

[Function]

Immediate data in the instruction word is transferred to the program counter (PC) and branched. This function is carried out when the “CALL !addr16” or “BR !addr16” or “CALLF !addr11” instruction is executed. The CALL !addr16 and BR !addr16 instructions can be branched to all memory spaces. The CALLF !addr11 instruction is branched to the area of 0800H to 0FFFH.

[Illustration]

CALL !addr16, BR !addr16 instruction

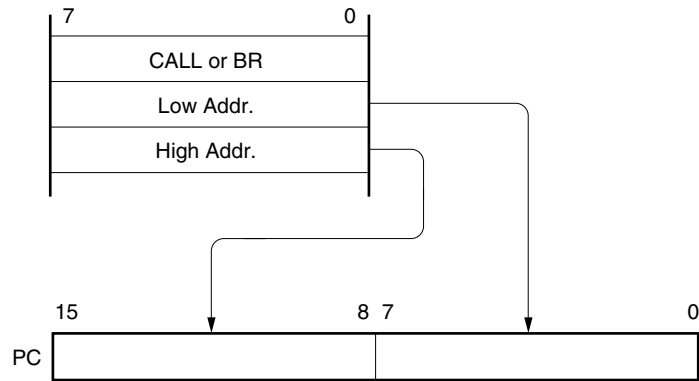

CALLF !addr11 instruction

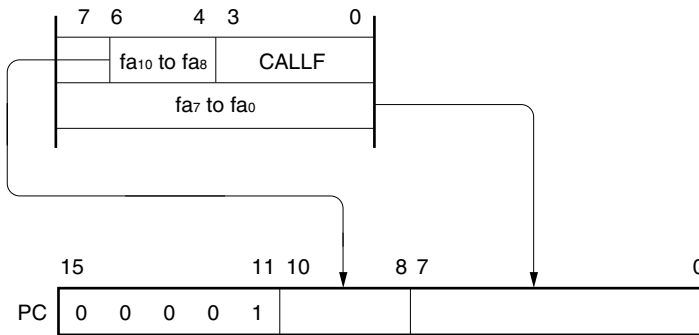

3.1.3 Table indirect addressing

[Function]

Table contents (branch destination address) of the particular location to be addressed by the lower-5-bit immediate data of an instruction code from bit 1 to bit 5 are transferred to the program counter (PC) and branched.

When the "CALLT [addr5]" instruction is executed, table indirect addressing is performed. Executing this instruction enables the value to be branched to all memory spaces referencing the address stored in the memory table of 40H to 7FH.

[Illustration]

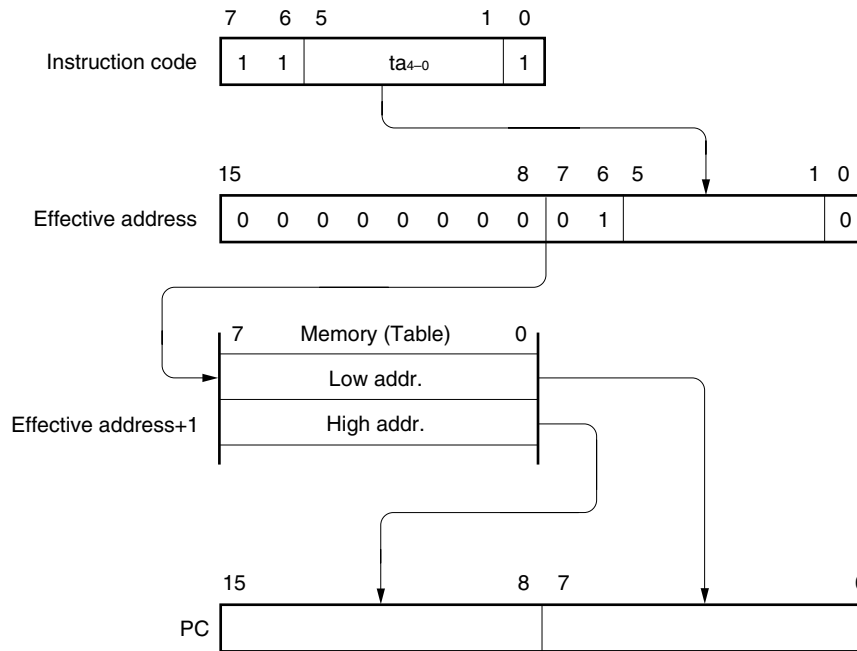

3.1.4 Register addressing

[Function]

The register pair (AX) contents to be specified by an instruction word are transferred to the program counter (PC) and branched.

This function is carried out when the “BR AX” instruction is executed.

[Illustration]

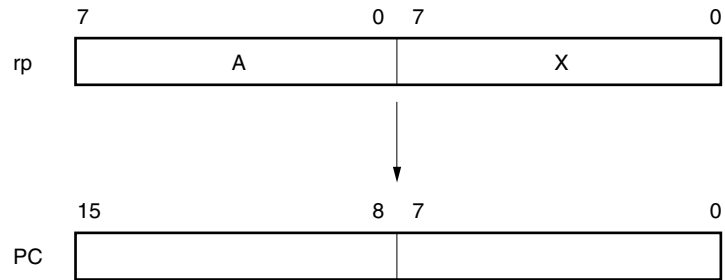

3.2 Operand Address Addressing

The following methods are available to specify the register and memory (addressing) to undergo manipulation during instruction execution.

3.2.1 Implied addressing

[Function]

This addressing automatically specifies the address of the registers that function as an accumulator (A and AX) in the general-purpose register area.

Of the 78K/0 Series instruction words, the following instructions employ implied addressing.

Instruction	Register to Be Specified by Implied Addressing
MULU	A register for multiplicand and AX register for product storage
DIVUW	AX register for dividend and quotient storage
ADJBA/ADJBS	A register for storage of numeric values targeted for decimal correction
ROR4/ROL4	A register for storage of digit data that undergoes digit rotation

[Operand format]

Because implied addressing can be automatically employed with an instruction, no particular operand format is necessary.

[Description example]

In the case of MULU X

With an 8-bit x 8-bit multiply instruction, the product of the A register and X register is stored in AX. In this example, the A and AX registers are specified by implied addressing.

3.2.2 Register addressing

[Function]

Register addressing accesses a general-purpose register as an operand. The general-purpose register to be accessed is specified by the register bank selection flags (RBS0 and RBS1) and the register specification codes (Rn and RPN) in the instruction codes.

Register addressing is carried out when an instruction with the following operand format is executed. When an 8-bit register is specified, one of the eight registers is specified by 3 bits in the instruction code.

[Operand format]

Identifier	Description
r	X, A, C, B, E, D, L, H
rp	AX, BC, DE, HL

'r' and 'rp' can be described with absolute names (R0 to R7 and RP0 to RP3) as well as function names (X, A, C, B, E, D, L, H, AX, BC, DE and HL).

[Description example]

MOV A, C; When selecting the C register for r

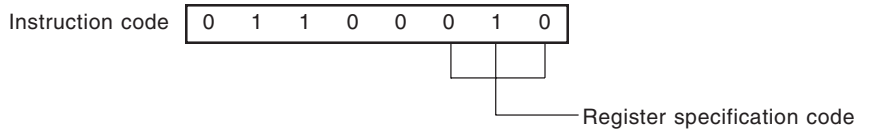

INCW DE; When selecting the DE register pair for rp

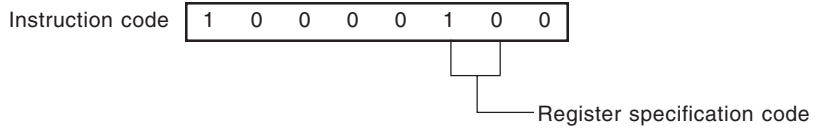

3.2.3 Direct addressing

[Function]

Direct addressing directly addresses the memory indicated by the immediate data in the instruction word.

[Operand format]

Identifier	Description
addr16	Label or 16-bit immediate data

[Description example]

MOV A, !FE00H; When setting !addr16 to FE00H

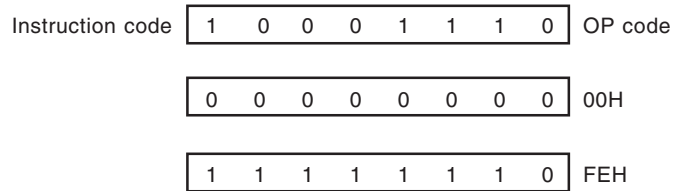

[Illustration]

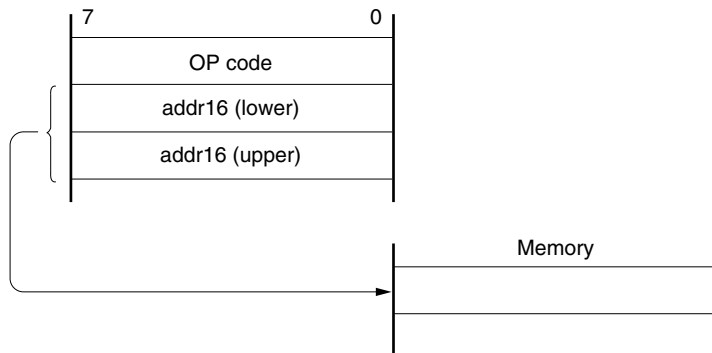

3.2.4 Short direct addressing

[Function]

The memory to be manipulated in the fixed space is directly addressed with 8-bit data in an instruction word. This addressing is applied to the 256-byte fixed space FE20H to FF1FH. An internal high-speed RAM and special function registers (SFRs) are mapped at FE20H to FEFFH and FF00H to FF1FH, respectively. The SFR area (FF00H to FF1FH) where short direct addressing is applied is a part of the entire SFR area. Ports that are frequently accessed in a program, a compare register of the timer/event counter and a capture register of the timer/event counter are mapped in the area FF00H through FF1FH, and these SFRs can be manipulated with a small number of bytes and clocks.

When 8-bit immediate data is at 20H to FFH, bit 8 of an effective address is set to 0. When it is at 00H to 1FH, bit 8 is set to 1. See [Illustration] below.

[Operand format]

Identifier	Description
saddr	Label or FE20H to FF1FH immediate data
saddrp	Label or FE20H to FF1FH immediate data (even address only)

[Description example]

MOV FE30H, #50H; When setting saddr to FE30H and the immediate data to 50H

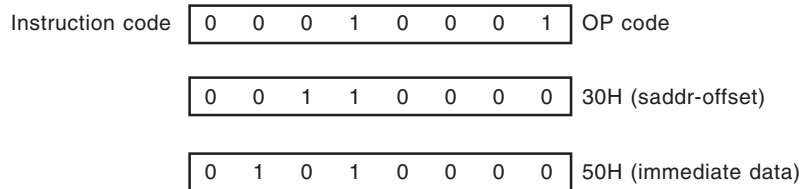

[Illustration]

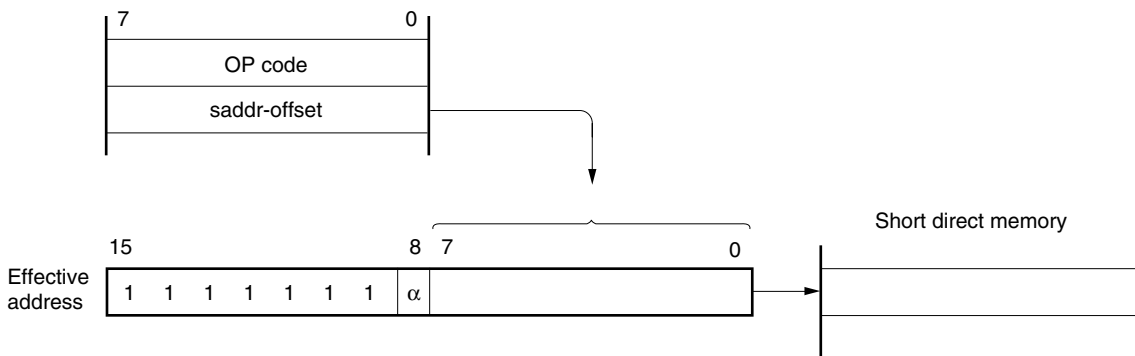

When 8-bit immediate data is 20H to FFH, $\alpha = 0$.
 When 8-bit immediate data is 00H to 1FH, $\alpha = 1$.

3.2.5 Special-function register (SFR) addressing

[Function]

A memory-mapped special function register (SFR) is addressed with 8-bit immediate data in an instruction word.

This addressing is applied to the 240-byte spaces FF00H to FFCFH and FFE0H to FFFFH. However, the SFRs mapped at FF00H to FF1FH can be accessed with short direct addressing.

[Operand format]

Identifier	Description
sfr	Special function register name
sfrp	16-bit-manipulatable special function register name (even address only)

[Description example]

MOV PM0, A; When selecting PM0 for sfr

Instruction code

1	1	1	1	0	1	1	0
---	---	---	---	---	---	---	---

 OP code

0	0	1	0	0	0	0	0
---	---	---	---	---	---	---	---

 20H (sfr-offset)

[Illustration]

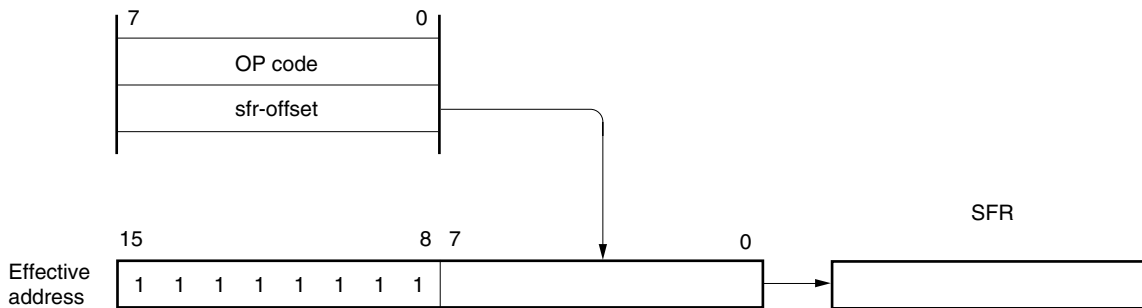

3.2.6 Register indirect addressing

[Function]

Register indirect addressing addresses memory with register pair contents specified as an operand. The register pair to be accessed is specified by the register bank selection flags (RBS0 and RBS1) and the register pair specification in instruction codes.

[Operand format]

Identifier	Description
—	[DE], [HL]

[Description example]

MOV A, [DE]; When selecting register pair [DE]

Instruction code

1	0	0	0	0	1	0	1
---	---	---	---	---	---	---	---

[Illustration]

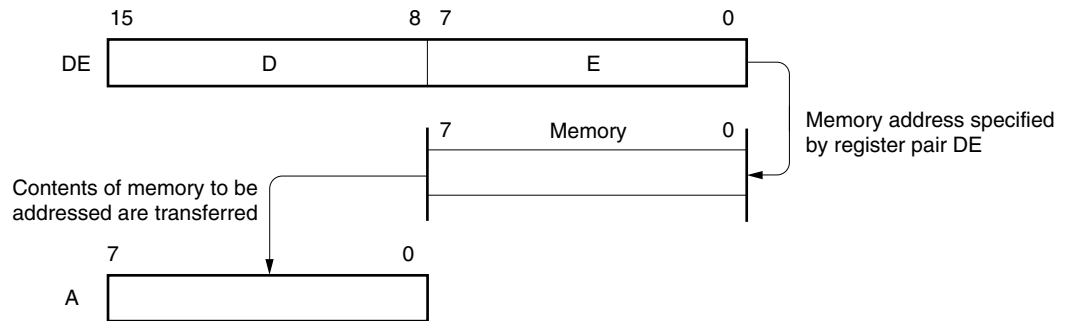

3.2.7 Based addressing

[Function]

8-bit immediate data is added to the contents of the HL register pair as a base register and the sum is used to address the memory. The HL register pair to be accessed is in the register bank specified by the register bank select flag (RBS0 and RBS1). Addition is performed by expanding the offset data as a positive number to 16 bits. A carry from the 16th bit is ignored. This addressing can be carried out for all the memory spaces.

[Operand format]

Identifier	Description
—	[HL+byte]

[Description example]

MOV A, [HL+10H]; When setting byte to 10H

Instruction code	1 0 1 0 1 1 1 0
	0 0 0 1 0 0 0 0

3.2.8 Based indexed addressing

[Function]

The B or C register contents specified in an instruction word are added to the contents of the HL register pair as a base register and the sum is used to address the memory. The HL, B, and C registers to be accessed are registers in the register bank specified by the register bank select flag (RBS0 to RBS1). Addition is performed by expanding the B or C register as a positive number to 16 bits. A carry from the 16th bit is ignored. This addressing can be carried out for all the memory spaces.

[Operand format]

Identifier	Description
—	[HL+B], [HL+C]

[Description example]

In the case of MOV A, [HL+B]

Instruction code	1 0 1 0 1 0 1 1
------------------	-----------------

3.2.9 Stack addressing

[Function]

The stack area is indirectly addressed with the stack pointer (SP) contents.

This addressing method is automatically employed when the PUSH, POP, subroutine call and RETURN instructions are executed or the register is saved/reset upon generation of an interrupt request.

Stack addressing enables addressing of the internal high-speed RAM area only.

[Description example]

In the case of PUSH DE

Instruction code

1	0	1	1	0	1	0	1
---	---	---	---	---	---	---	---

CHAPTER 4 INSTRUCTION SET

This chapter lists the instructions in the 78K/0 Series instruction set. The instructions are common to all 78K/0 Series products.

4.1 Operation

- ★ For the operation list for each product, refer to the user's manual of each product.

4.1.1 Operand identifiers and description methods

Operands are described in the "Operand" column of each instruction in accordance with the description method of the instruction operand identifier (refer to the assembler specifications for details). When there are two or more description methods, select one of them. Alphabetic letters in capitals and the symbols, #, !, \$ and [] are key words and are described as they are. Each symbol has the following meaning.

- #: Immediate data specification
- !: Absolute address specification
- \$: Relative address specification
- []: Indirect address specification

In the case of immediate data, describe an appropriate numeric value or a label. When using a label, be sure to describe the #, !, \$ and [] symbols.

For operand register identifiers, r and rp, either function names (X, A, C, etc.) or absolute names (names in parentheses in the table below, R0, R1, R2, etc.) can be used for description.

Table 4-1. Operand Identifiers and Description Methods

Identifier	Description Method
r	X (R0), A (R1), C (R2), B (R3), E (R4), D (R5), L (R6), H (R7)
rp	AX (RP0), BC (RP1), DE (RP2), HL (RP3)
sfr	Special-function register symbol ^{Note}
sfrp	Special-function register symbols (16-bit manipulatable register even addresses only) ^{Note}
saddr	FE20H to FF1FH Immediate data or labels
saddrp	FE20H to FF1FH Immediate data or labels (even addresses only)
addr16	0000H to FFFFH Immediate data or labels (Only even addresses for 16-bit data transfer instructions)
addr11	0800H to 0FFFH Immediate data or labels
addr5	0040H to 007FH Immediate data or labels (even addresses only)
word	16-bit immediate data or label
byte	8-bit immediate data or label
bit	3-bit immediate data or label
RBn	RB0 to RB3

Note FFD0H to FFDFH are not addressable.

Remark Refer to the user's manual of each product for the symbols of special function registers.

4.1.2 Description of “operation” column

A:	A register; 8-bit accumulator
X:	X register
B:	B register
C:	C register
D:	D register
E:	E register
H:	H register
L:	L register
AX:	AX register pair; 16-bit accumulator
BC:	BC register pair
DE:	DE register pair
HL:	HL register pair
PC:	Program counter
SP:	Stack pointer
PSW:	Program status word
CY:	Carry flag
AC:	Auxiliary carry flag
Z:	Zero flag
RBS:	Register bank select flag
IE:	Interrupt request enable flag
NMIS:	Flag indicating non-maskable interrupt servicing in progress
():	Memory contents indicated by address or register contents in parentheses
X _H , X _L :	Higher 8 bits and lower 8 bits of 16-bit register
Λ:	Logical product (AND)
V:	Logical sum (OR)
∨:	Exclusive logical sum (exclusive OR)
—:	Inverted data
addr16:	16-bit immediate data or label
jdisp8:	Signed 8-bit data (displacement value)

4.1.3 Description of “flag operation” column

(Blank):	Unchanged
0:	Cleared to 0
1:	Set to 1
×	Set/cleared according to the result
R:	Previously saved value is restored

4.1.4 Description of number of clocks

1 instruction clock cycle is 1 CPU clock cycle (f_{CPU}) selected by the processor clock control register (PCC).

4.1.5 Instructions listed by addressing type

(1) 8-bit instructions

MOV, XCH, ADD, ADDC, SUB, SUBC, AND, OR, XOR, CMP, MULU, DIVUW, INC, DEC, ROR, ROL, RORC, ROLC, ROR4, ROL4, PUSH, POP, DBNZ

CHAPTER 4 INSTRUCTION SET

2nd Operand 1st Operand	#byte	A	r ^{Note}	sfr	saddr	!addr16	PSW	[DE]	[HL]	[HL+byte] [HL+B] [HL+C]	\$addr16	1	None
A	ADD ADDC SUB SUBC AND OR XOR CMP		MOV XCH ADD ADDC SUB SUBC AND OR XOR CMP	MOV XCH	MOV XCH ADD ADDC SUB SUBC AND OR XOR CMP	MOV XCH ADD ADDC SUB SUBC AND OR XOR CMP	MOV	MOV XCH	MOV XCH ADD ADDC SUB SUBC AND OR XOR CMP	MOV XCH ADD ADDC SUB SUBC AND OR XOR CMP		ROR ROL RORC ROLC	
r	MOV	MOV ADD ADDC SUB SUBC AND OR XOR CMP											INC DEC
B, C											DBNZ		
sfr	MOV	MOV											
saddr	MOV ADD ADDC SUB SUBC AND OR XOR CMP	MOV									DBNZ		INC DEC
!addr16		MOV											
PSW	MOV	MOV											PUSH POP
[DE]		MOV											
[HL]		MOV											ROR4 ROL4
[HL+byte] [HL+B] [HL+C]		MOV											
X													MULU
C													DIVUW

Note Except r = A.

(2) 16-bit instructions

MOVW, XCHW, ADDW, SUBW, CMPW, PUSH, POP, INCW, DECW

2nd Operand \ 1st Operand	#word	AX	rp ^{Note}	sfrp	saddrp	!addr16	SP	None
AX	ADDW SUBW CMPW		MOVW XCHW	MOVW	MOVW	MOVW	MOVW	
rp	MOVW	MOVW ^{Note}						INCW DECW PUSH POP
sfrp	MOVW	MOVW						
saddrp	MOVW	MOVW						
!addr16		MOVW						
SP	MOVW	MOVW						

Note Only when rp = BC, DE or HL.

(3) Bit manipulation instructions

MOV1, AND1, OR1, XOR1, SET1, CLR1, NOT1, BT, BF, BTCLR

2nd Operand \ 1st Operand	A.bit	sfr.bit	saddr.bit	PSW.bit	[HL].bit	CY	\$addr16	None
A.bit						MOV1	BT BF BTCLR	SET1 CLR1
sfr.bit						MOV1	BT BF BTCLR	SET1 CLR1
saddr.bit						MOV1	BT BF BTCLR	SET1 CLR1
PSW.bit						MOV1	BT BF BTCLR	SET1 CLR1
[HL].bit						MOV1	BT BF BTCLR	SET1 CLR1
CY	MOV1 AND1 OR1 XOR1	MOV1 AND1 OR1 XOR1	MOV1 AND1 OR1 XOR1	MOV1 AND1 OR1 XOR1	MOV1 AND1 OR1 XOR1			SET1 CLR1 NOT1

(4) Call instructions/branch instructions

CALL, CALLF, CALLT, BR, BC, BNC, BZ, BNZ, BT, BF, BTCLR, DBNZ

2nd Operand 1st Operand	AX	!addr16	!addr11	[addr5]	\$addr16
Basic Instructions	BR	CALL BR	CALLF	CALLT	BR BC BNC BZ BNZ
Compound Instructions					BT BF BTCLR DBNZ

(5) Other instructions

ADJBA, ADJBS, BRK, RET, RETI, RETB, SEL, NOP, EI, DI, HALT, STOP

4.2 Instruction Codes

4.2.1 Description of instruction code table

R ₂	R ₁	R ₀	reg	
0	0	0	R0	X
0	0	1	R1	A
0	1	0	R2	C
0	1	1	R3	B
1	0	0	R4	E
1	0	1	R5	D
1	1	0	R6	L
1	1	1	R7	H

P ₁	P ₀	reg-pair	
0	0	RP0	AX
0	1	RP1	BC
1	0	RP2	DE
1	1	RP3	HL

RB ₁	RB ₀	reg-bank
0	0	RB0
0	1	RB1
1	0	RB2
1	1	RB3

- Bn: Immediate data corresponding to bit
- Data: 8-bit immediate data corresponding to byte
- Low/High byte: 16-bit immediate data corresponding to word
- Saddr-offset: 16-bit address lower 8-bit offset data corresponding to saddr
- Sfr-offset: sfr 16-bit address lower 8-bit offset data
- Low/High addr: 16-bit immediate data corresponding to addr16
- jdisp: Signed two's complement data (8 bits) of relative address distance between the start and branch addresses of the next instruction
- fa₁₀ to fa₀: 11 bits of immediate data corresponding to addr11
- ta₄ to ta₀: 5 bits of immediate data corresponding to addr5

4.2.2 Instruction code list

Instruction Group	Mnemonic	Operands	Operation Code			
			B1	B2	B3	B4
8-Bit Data Transfer	MOV	r,#byte	1 0 1 0 0 R ₂ R ₁ R ₀	Data		
		saddr,#byte	0 0 0 1 0 0 0 1	Saddr-offset	Data	
		sfr,#byte	0 0 0 1 0 0 1 1	Sfr-offset	Data	
		A,r	Note 0 1 1 0 0 R ₂ R ₁ R ₀			
		r,A	Note 0 1 1 1 0 R ₂ R ₁ R ₀			
		A,saddr	1 1 1 1 0 0 0 0	Saddr-offset		
		saddr,A	1 1 1 1 0 0 1 0	Saddr-offset		
		A,sfr	1 1 1 1 0 1 0 0	Sfr-offset		
		sfr,A	1 1 1 1 0 1 1 0	Sfr-offset		
		A,!addr16	1 0 0 0 1 1 1 0	Low addr	High addr	
		!addr16,A	1 0 0 1 1 1 1 0	Low addr	High addr	
		PSW,#byte	0 0 0 1 0 0 0 1	0 0 0 1 1 1 1 0	Data	
		A,PSW	1 1 1 1 0 0 0 0	0 0 0 1 1 1 1 0		
		PSW,A	1 1 1 1 0 0 1 0	0 0 0 1 1 1 1 0		
		A,[DE]	1 0 0 0 0 1 0 1			
		[DE],A	1 0 0 1 0 1 0 1			
		A,[HL]	1 0 0 0 0 1 1 1			
		[HL],A	1 0 0 1 0 1 1 1			
		A,[HL+byte]	1 0 1 0 1 1 1 0	Data		
		[HL+byte],A	1 0 1 1 1 1 1 0	Data		
	A,[HL+B]	1 0 1 0 1 0 1 1				
	[HL+B],A	1 0 1 1 1 0 1 1				
	A,[HL+C]	1 0 1 0 1 0 1 0				
	[HL+C],A	1 0 1 1 1 0 1 0				
	XCH	A,r	Note 0 0 1 1 0 R ₂ R ₁ R ₀			
		A,saddr	1 0 0 0 0 0 1 1	Saddr-offset		
		A,sfr	1 0 0 1 0 0 1 1	Sfr-offset		
		A,!addr16	1 1 0 0 1 1 1 0	Low addr	High addr	
		A,[DE]	0 0 0 0 0 1 0 1			
		A,[HL]	0 0 0 0 0 1 1 1			
		A,[HL+byte]	1 1 0 1 1 1 1 0	Data		
		A,[HL+B]	0 0 1 1 0 0 0 1	1 0 0 0 1 0 1 1		
A,[HL+C]	0 0 1 1 0 0 0 1	1 0 0 0 1 0 1 0				

Note Except r = A.

CHAPTER 4 INSTRUCTION SET

Instruction Group	Mnemonic	Operands	Operation Code			
			B1	B2	B3	B4
16-Bit Data Transfer	MOVW	rp,#word	0 0 0 1 0 P ₁ P ₀ 0	Low byte	High byte	
		saddrp,#word	1 1 1 0 1 1 1 0	Saddr-offset	Low byte	High byte
		sfrp,#word	1 1 1 1 1 1 1 0	Sfr-offset	Low byte	High byte
		AX,saddrp	1 0 0 0 1 0 0 1	Saddr-offset		
		saddrp,AX	1 0 0 1 1 0 0 1	Saddr-offset		
		AX,sfrp	1 0 1 0 1 0 0 1	Sfr-offset		
		sfrp,AX	1 0 1 1 1 0 0 1	Sfr-offset		
		AX,rp <small>Note 1</small>	1 1 0 0 0 P ₁ P ₀ 0			
		rp,AX <small>Note 1</small>	1 1 0 1 0 P ₁ P ₀ 0			
		AX,laddr16	0 0 0 0 0 0 1 0	Low addr	High addr	
		laddr16,AX	0 0 0 0 0 0 1 1	Low addr	High addr	
	XCHW	AX,rp <small>Note 1</small>	1 1 1 0 0 P ₁ P ₀ 0			
8-Bit Operation	ADD	A,#byte	0 0 0 0 1 1 0 1	Data		
		saddr,#byte	1 0 0 0 1 0 0 0	Saddr-offset	Data	
		A,r <small>Note 2</small>	0 1 1 0 0 0 0 1	0 0 0 0 1 R ₂ R ₁ R ₀		
		r,A	0 1 1 0 0 0 0 1	0 0 0 0 0 R ₂ R ₁ R ₀		
		A,saddr	0 0 0 0 1 1 1 0	Saddr-offset		
		A,laddr16	0 0 0 0 1 0 0 0	Low addr	High addr	
		A,[HL]	0 0 0 0 1 1 1 1			
		A,[HL+byte]	0 0 0 0 1 0 0 1	Data		
		A,[HL+B]	0 0 1 1 0 0 0 1	0 0 0 0 1 0 1 1		
		A,[HL+C]	0 0 1 1 0 0 0 1	0 0 0 0 1 0 1 0		
	ADDC	A,#byte	0 0 1 0 1 1 0 1	Data		
		saddr,#byte	1 0 1 0 1 0 0 0	Saddr-offset	Data	
		A,r <small>Note 2</small>	0 1 1 0 0 0 0 1	0 0 1 0 1 R ₂ R ₁ R ₀		
		r,A	0 1 1 0 0 0 0 1	0 0 1 0 0 R ₂ R ₁ R ₀		
		A,saddr	0 0 1 0 1 1 1 0	Saddr-offset		
		A,laddr16	0 0 1 0 1 0 0 0	Low addr	High addr	
		A,[HL]	0 0 1 0 1 1 1 1			
		A,[HL+byte]	0 0 1 0 1 0 0 1	Data		
		A,[HL+B]	0 0 1 1 0 0 0 1	0 0 1 0 1 0 1 1		
A,[HL+C]	0 0 1 1 0 0 0 1	0 0 1 0 1 0 1 0				

Notes 1. Only when rp = BC, DE or HL.

2. Except r = A.

CHAPTER 4 INSTRUCTION SET

Instruction Group	Mnemonic	Operands	Operation Code			
			B1	B2	B3	B4
8-Bit Operation	SUB	A,#byte	0 0 0 1 1 1 0 1	Data		
		saddr,#byte	1 0 0 1 1 0 0 0	Saddr-offset	Data	
		A,r Note	0 1 1 0 0 0 0 1	0 0 0 1 1 R ₂ R ₁ R ₀		
		r,A	0 1 1 0 0 0 0 1	0 0 0 1 0 R ₂ R ₁ R ₀		
		A,saddr	0 0 0 1 1 1 1 0	Saddr-offset		
		A,!addr16	0 0 0 1 1 0 0 0	Low addr	High addr	
		A,[HL]	0 0 0 1 1 1 1 1			
		A,[HL+byte]	0 0 0 1 1 0 0 1	Data		
		A,[HL+B]	0 0 1 1 0 0 0 1	0 0 0 1 1 0 1 1		
		A,[HL+C]	0 0 1 1 0 0 0 1	0 0 0 1 1 0 1 0		
	SUBC	A,#byte	0 0 1 1 1 1 0 1	Data		
		saddr,#byte	1 0 1 1 1 0 0 0	Saddr-offset	Data	
		A,r Note	0 1 1 0 0 0 0 1	0 0 1 1 1 R ₂ R ₁ R ₀		
		r,A	0 1 1 0 0 0 0 1	0 0 1 1 0 R ₂ R ₁ R ₀		
		A,saddr	0 0 1 1 1 1 1 0	Saddr-offset		
		A,!addr16	0 0 1 1 1 0 0 0	Low addr	High addr	
		A,[HL]	0 0 1 1 1 1 1 1			
		A,[HL+byte]	0 0 1 1 1 0 0 1	Data		
		A,[HL+B]	0 0 1 1 0 0 0 1	0 0 1 1 1 0 1 1		
		A,[HL+C]	0 0 1 1 0 0 0 1	0 0 1 1 1 0 1 0		
	AND	A,#byte	0 1 0 1 1 1 0 1	Data		
		saddr,#byte	1 1 0 1 1 0 0 0	Saddr-offset	Data	
		A,r Note	0 1 1 0 0 0 0 1	0 1 0 1 1 R ₂ R ₁ R ₀		
		r,A	0 1 1 0 0 0 0 1	0 1 0 1 0 R ₂ R ₁ R ₀		
		A,saddr	0 1 0 1 1 1 1 0	Saddr-offset		
		A,!addr16	0 1 0 1 1 0 0 0	Low addr	High addr	
		A,[HL]	0 1 0 1 1 1 1 1			
		A,[HL+byte]	0 1 0 1 1 0 0 1	Data		
		A,[HL+B]	0 0 1 1 0 0 0 1	0 1 0 1 1 0 1 1		
		A,[HL+C]	0 0 1 1 0 0 0 1	0 1 0 1 1 0 1 0		

Note Except r = A.

CHAPTER 4 INSTRUCTION SET

Instruction Group	Mnemonic	Operands	Operation Code			
			B1	B2	B3	B4
8-Bit Operation	OR	A,#byte	0 1 1 0 1 1 0 1	Data		
		saddr,#byte	1 1 1 0 1 0 0 0	Saddr-offset	Data	
		A,r Note	0 1 1 0 0 0 0 1	0 1 1 0 1 R ₂ R ₁ R ₀		
		r,A	0 1 1 0 0 0 0 1	0 1 1 0 0 R ₂ R ₁ R ₀		
		A,saddr	0 1 1 0 1 1 1 0	Saddr-offset		
		A,!addr16	0 1 1 0 1 0 0 0	Low addr	High addr	
		A,[HL]	0 1 1 0 1 1 1 1			
		A,[HL+byte]	0 1 1 0 1 0 0 1	Data		
		A,[HL+B]	0 0 1 1 0 0 0 1	0 1 1 0 1 0 1 1		
		A,[HL+C]	0 0 1 1 0 0 0 1	0 1 1 0 1 0 1 0		
	XOR	A,#byte	0 1 1 1 1 1 0 1	Data		
		saddr,#byte	1 1 1 1 1 0 0 0	Saddr-offset	Data	
		A,r Note	0 1 1 0 0 0 0 1	0 1 1 1 1 R ₂ R ₁ R ₀		
		r,A	0 1 1 0 0 0 0 1	0 1 1 1 0 R ₂ R ₁ R ₀		
		A,saddr	0 1 1 1 1 1 1 0	Saddr-offset		
		A,!addr16	0 1 1 1 1 0 0 0	Low addr	High addr	
		A,[HL]	0 1 1 1 1 1 1 1			
		A,[HL+byte]	0 1 1 1 1 0 0 1	Data		
		A,[HL+B]	0 0 1 1 0 0 0 1	0 1 1 1 1 0 1 1		
		A,[HL+C]	0 0 1 1 0 0 0 1	0 1 1 1 1 0 1 0		
	CMP	A,#byte	0 1 0 0 1 1 0 1	Data		
		saddr,#byte	1 1 0 0 1 0 0 0	Saddr-offset	Data	
		A,r Note	0 1 1 0 0 0 0 1	0 1 0 0 1 R ₂ R ₁ R ₀		
		r,A	0 1 1 0 0 0 0 1	0 1 0 0 0 R ₂ R ₁ R ₀		
		A,saddr	0 1 0 0 1 1 1 0	Saddr-offset		
		A,!addr16	0 1 0 0 1 0 0 0	Low addr	High addr	
		A,[HL]	0 1 0 0 1 1 1 1			
		A,[HL+byte]	0 1 0 0 1 0 0 1	Data		
		A,[HL+B]	0 0 1 1 0 0 0 1	0 1 0 0 1 0 1 1		
		A,[HL+C]	0 0 1 1 0 0 0 1	0 1 0 0 1 0 1 0		

Note Except r = A.

CHAPTER 4 INSTRUCTION SET

Instruction Group	Mnemonic	Operands	Operation Code			
			B1	B2	B3	B4
16-Bit Operation	ADDW	AX,#word	1 1 0 0 1 0 1 0	Low byte	High byte	
	SUBW	AX,#word	1 1 0 1 1 0 1 0	Low byte	High byte	
	CMPW	AX,#word	1 1 1 0 1 0 1 0	Low byte	High byte	
Multiply/divide	MULU	X	0 0 1 1 0 0 0 1	1 0 0 0 1 0 0 0		
	DIVUW	C	0 0 1 1 0 0 0 1	1 0 0 0 0 0 1 0		
Increment/decrement	INC	r	0 1 0 0 0 R ₂ R ₁ R ₀			
		saddr	1 0 0 0 0 0 0 1	Saddr-offset		
	DEC	r	0 1 0 1 0 R ₂ R ₁ R ₀			
		saddr	1 0 0 1 0 0 0 1	Saddr-offset		
	INCW	rp	1 0 0 0 0 P ₁ P ₀ 0			
	DECW	rp	1 0 0 1 0 P ₁ P ₀ 0			
Rotate	ROR	A,1	0 0 1 0 0 1 0 0			
	ROL	A,1	0 0 1 0 0 1 1 0			
	RORC	A,1	0 0 1 0 0 1 0 1			
	ROLC	A,1	0 0 1 0 0 1 1 1			
	ROR4	[HL]	0 0 1 1 0 0 0 1	1 0 0 1 0 0 0 0		
	ROL4	[HL]	0 0 1 1 0 0 0 1	1 0 0 0 0 0 0 0		
BCD Adjust	ADJBA		0 1 1 0 0 0 0 1	1 0 0 0 0 0 0 0		
	ADJBS		0 1 1 0 0 0 0 1	1 0 0 1 0 0 0 0		
Bit Manipulation	MOV1	CY,saddr.bit	0 1 1 1 0 0 0 1	0 B ₂ B ₁ B ₀ 0 1 0 0	Saddr-offset	
		CY,sfr.bit	0 1 1 1 0 0 0 1	0 B ₂ B ₁ B ₀ 1 1 0 0	Sfr-offset	
		CY,A.bit	0 1 1 0 0 0 0 1	1 B ₂ B ₁ B ₀ 1 1 0 0		
		CY,PSW.bit	0 1 1 1 0 0 0 1	0 B ₂ B ₁ B ₀ 0 1 0 0	0 0 0 1 1 1 1 0	
		CY,[HL].bit	0 1 1 1 0 0 0 1	1 B ₂ B ₁ B ₀ 0 1 0 0		
		saddr.bit,CY	0 1 1 1 0 0 0 1	0 B ₂ B ₁ B ₀ 0 0 0 1	Saddr-offset	
		sfr.bit,CY	0 1 1 1 0 0 0 1	0 B ₂ B ₁ B ₀ 1 0 0 1	Sfr-offset	
		A.bit,CY	0 1 1 0 0 0 0 1	1 B ₂ B ₁ B ₀ 1 0 0 1		
		PSW.bit,CY	0 1 1 1 0 0 0 1	0 B ₂ B ₁ B ₀ 0 0 0 1	0 0 0 1 1 1 1 0	
	[HL].bit,CY	0 1 1 1 0 0 0 1	1 B ₂ B ₁ B ₀ 0 0 0 1			
	AND1	CY,saddr.bit	0 1 1 1 0 0 0 1	0 B ₂ B ₁ B ₀ 0 1 0 1	Saddr-offset	
		CY,sfr.bit	0 1 1 1 0 0 0 1	0 B ₂ B ₁ B ₀ 1 1 0 1	Sfr-offset	
		CY,A.bit	0 1 1 0 0 0 0 1	1 B ₂ B ₁ B ₀ 1 1 0 1		
		CY,PSW.bit	0 1 1 1 0 0 0 1	0 B ₂ B ₁ B ₀ 0 1 0 1	0 0 0 1 1 1 1 0	
		CY,[HL].bit	0 1 1 1 0 0 0 1	1 B ₂ B ₁ B ₀ 0 1 0 1		

CHAPTER 4 INSTRUCTION SET

Instruction Group	Mnemonic	Operands	Operation Code			
			B1	B2	B3	B4
Bit Manipulation	OR1	CY,saddr.bit	0 1 1 1 0 0 0 1	0 B ₂ B ₁ B ₀ 0 1 1 0	Saddr-offset	
		CY,sfr.bit	0 1 1 1 0 0 0 1	0 B ₂ B ₁ B ₀ 1 1 1 0	Sfr-offset	
		CY,A.bit	0 1 1 0 0 0 0 1	1 B ₂ B ₁ B ₀ 1 1 1 0		
		CY,PSW.bit	0 1 1 1 0 0 0 1	0 B ₂ B ₁ B ₀ 0 1 1 0	0 0 0 1 1 1 1 0	
		CY,[HL].bit	0 1 1 1 0 0 0 1	1 B ₂ B ₁ B ₀ 0 1 1 0		
	XOR1	CY,saddr.bit	0 1 1 1 0 0 0 1	0 B ₂ B ₁ B ₀ 0 1 1 1	Saddr-offset	
		CY,sfr.bit	0 1 1 1 0 0 0 1	0 B ₂ B ₁ B ₀ 1 1 1 1	Sfr-offset	
		CY,A.bit	0 1 1 0 0 0 0 1	1 B ₂ B ₁ B ₀ 1 1 1 1		
		CY,PSW.bit	0 1 1 1 0 0 0 1	0 B ₂ B ₁ B ₀ 0 1 1 1	0 0 0 1 1 1 1 0	
		CY,[HL].bit	0 1 1 1 0 0 0 1	1 B ₂ B ₁ B ₀ 0 1 1 1		
	SET1	saddr.bit	0 B ₂ B ₁ B ₀ 1 0 1 0	Saddr-offset		
		sfr.bit	0 1 1 1 0 0 0 1	0 B ₂ B ₁ B ₀ 1 0 1 0	Sfr-offset	
		A.bit	0 1 1 0 0 0 0 1	1 B ₂ B ₁ B ₀ 1 0 1 0		
		PSW.bit	0 B ₂ B ₁ B ₀ 1 0 1 0	0 0 0 1 1 1 1 0		
		[HL].bit	0 1 1 1 0 0 0 1	1 B ₂ B ₁ B ₀ 0 0 1 0		
	CLR1	saddr.bit	0 B ₂ B ₁ B ₀ 1 0 1 1	Saddr-offset		
		sfr.bit	0 1 1 1 0 0 0 1	0 B ₂ B ₁ B ₀ 1 0 1 1	Sfr-offset	
		A.bit	0 1 1 0 0 0 0 1	1 B ₂ B ₁ B ₀ 1 0 1 1		
		PSW.bit	0 B ₂ B ₁ B ₀ 1 0 1 1	0 0 0 1 1 1 1 0		
		[HL].bit	0 1 1 1 0 0 0 1	1 B ₂ B ₁ B ₀ 0 0 1 1		
SET1	CY	0 0 1 0 0 0 0 0				
CLR1	CY	0 0 1 0 0 0 0 1				
NOT1	CY	0 0 0 0 0 0 0 1				
Call Return	CALL	!addr16	1 0 0 1 1 0 1 0	Low addr	High addr	
	CALLF	!addr11	0 fa ₁₀₋₈ 1 1 0 0	fa ₇₋₀		
	CALLT	[addr5]	1 1 ta ₄₋₀ 1			
	BRK		1 0 1 1 1 1 1 1			
	RET		1 0 1 0 1 1 1 1			
	RETB		1 0 0 1 1 1 1 1			
	RETI		1 0 0 0 1 1 1 1			
Stack Manipulation	PUSH	PSW	0 0 1 0 0 0 1 0			
		rp	1 0 1 1 0 P ₁ P ₀ 1			
	POP	PSW	0 0 1 0 0 0 1 1			
		rp	1 0 1 1 0 P ₁ P ₀ 0			
	MOVW	SP,#word	1 1 1 0 1 1 1 0	0 0 0 1 1 1 0 0	Low byte	High byte
		SP,AX	1 0 0 1 1 0 0 1	0 0 0 1 1 1 0 0		
AX,SP		1 0 0 0 1 0 0 1	0 0 0 1 1 1 0 0			

CHAPTER 4 INSTRUCTION SET

Instruction Group	Mnemonic	Operands	Operation Code				
			B1	B2	B3	B4	
Unconditional Branch	BR	!addr16	1 0 0 1 1 0 1 1	Low addr	High addr		
		\$addr16	1 1 1 1 1 0 1 0	jdisp			
		AX	0 0 1 1 0 0 0 1	1 0 0 1 1 0 0 0			
Conditional Branch	BC	\$addr16	1 0 0 0 1 1 0 1	jdisp			
	BNC	\$addr16	1 0 0 1 1 1 0 1	jdisp			
	BZ	\$addr16	1 0 1 0 1 1 0 1	jdisp			
	BNZ	\$addr16	1 0 1 1 1 1 0 1	jdisp			
	BT	saddr.bit,\$addr16	1 B ₂ B ₁ B ₀ 1 1 0 0	Saddr-offset	jdisp		
		sfr.bit,\$addr16	0 0 1 1 0 0 0 1	0 B ₂ B ₁ B ₀ 0 1 1 0	Sfr-offset	jdisp	
		A.bit,\$addr16	0 0 1 1 0 0 0 1	0 B ₂ B ₁ B ₀ 1 1 1 0	jdisp		
		PSW.bit,\$addr16	1 B ₂ B ₁ B ₀ 1 1 0 0	0 0 0 1 1 1 1 0	jdisp		
		[HL].bit,\$addr16	0 0 1 1 0 0 0 1	1 B ₂ B ₁ B ₀ 0 1 1 0	jdisp		
		BF	saddr.bit,\$addr16	0 0 1 1 0 0 0 1	0 B ₂ B ₁ B ₀ 0 0 1 1	Saddr-offset	jdisp
			sfr.bit,\$addr16	0 0 1 1 0 0 0 1	0 B ₂ B ₁ B ₀ 0 1 1 1	Sfr-offset	jdisp
	A.bit,\$addr16		0 0 1 1 0 0 0 1	0 B ₂ B ₁ B ₀ 1 1 1 1	jdisp		
	PSW.bit,\$addr16		0 0 1 1 0 0 0 1	0 B ₂ B ₁ B ₀ 0 0 1 1	0 0 0 1 1 1 1 0	jdisp	
	[HL].bit,\$addr16		0 0 1 1 0 0 0 1	1 B ₂ B ₁ B ₀ 0 1 1 1	jdisp		
	BTCLR	saddr.bit,\$addr16	0 0 1 1 0 0 0 1	0 B ₂ B ₁ B ₀ 0 0 0 1	Saddr-offset	jdisp	
		sfr.bit,\$addr16	0 0 1 1 0 0 0 1	0 B ₂ B ₁ B ₀ 0 1 0 1	Sfr-offset	jdisp	
		A.bit,\$addr16	0 0 1 1 0 0 0 1	0 B ₂ B ₁ B ₀ 1 1 0 1	jdisp		
		PSW.bit,\$addr16	0 0 1 1 0 0 0 1	0 B ₂ B ₁ B ₀ 0 0 0 1	0 0 0 1 1 1 1 0	jdisp	
		[HL].bit,\$addr16	0 0 1 1 0 0 0 1	1 B ₂ B ₁ B ₀ 0 1 0 1	jdisp		
	DBNZ	B,\$addr16	1 0 0 0 1 0 1 1	jdisp			
		C,\$addr16	1 0 0 0 1 0 1 0	jdisp			
		saddr,\$addr16	0 0 0 0 0 1 0 0	Saddr-offset	jdisp		
	CPU control	SEL	RBn	0 1 1 0 0 0 0 1	1 1 RB ₁ 1 RB ₀ 0 0 0		
		NOP		0 0 0 0 0 0 0 0			
EI			0 1 1 1 1 0 1 0	0 0 0 1 1 1 1 0			
DI			0 1 1 1 1 0 1 1	0 0 0 1 1 1 1 0			
HALT			0 1 1 1 0 0 0 1	0 0 0 1 0 0 0 0			
STOP			0 1 1 1 0 0 0 1	0 0 0 0 0 0 0 0			

CHAPTER 5 EXPLANATION OF INSTRUCTIONS

This chapter explains the instructions of 78K/0 Series products. Each instruction is described with a mnemonic, including description of multiple operands.

The basic configuration of instruction description is shown on the next page.

- ★ For the number of instruction bytes and the instruction codes, refer to the user's manual of each product and **CHAPTER 4 INSTRUCTION SET**, respectively.

All the instructions are common to 78K/0 Series products.

DESCRIPTION EXAMPLE

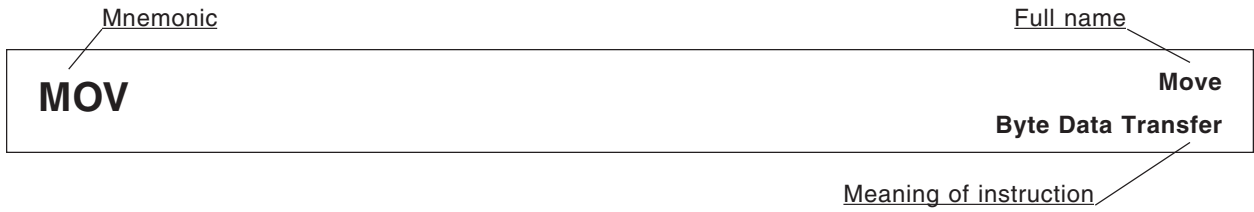

[Instruction format] **MOV dst, src:** Indicates the basic description format of the instruction.

[Operation] **dst ← src:** Indicates instruction operation using symbols.

[Operand] Indicates operands that can be specified by this instruction. Refer to **4.1 Operation** for the description of each operand symbol.

Mnemonic	Operand(dst,src)
MOV	r, #byte
	~ A, saddr
	saddr, A
	~ PSW, #byte

Mnemonic	Operand(dst,src)
MOV	A, PSW
	~ [HL], A
	A, [HL+byte]
	~ [HL+C], A

[Flag] Indicates the flag operation that changes by instruction execution. Each flag operation symbol is shown in the conventions.

Z	AC	CY

Conventions

Symbol	Description
Blank	Unchanged
0	Cleared to 0
1	Set to 1
X	Set or cleared according to the result
R	Previously saved value is restored

[Description]: Describes the instruction operation in detail.

- The contents of the source operand (src) specified by the 2nd operand are transferred to the destination operand (dst) specified by the 1st operand.

[Description example]

MOV A, #4DH; 4DH is transferred to the A register.

5.1 8-Bit Data Transfer Instructions

The following instructions are 8-bit data transfer instructions.

MOV ... 49

XCH ... 50

MOV	Move Byte Data Transfer
------------	--

[Instruction format] **MOV dst, src**

[Operation] **dst ← src**

[Operand]

Mnemonic	Operand(dst,src)
MOV	r, #byte
	saddr, #byte
	sfr, #byte
	A, r Note
	r, A Note
	A, saddr
	saddr, A
	A, sfr
	sfr, A
	A, laddr16
	laddr16, A
	PSW, #byte

Mnemonic	Operand(dst,src)
MOV	A, PSW
	PSW, A
	A, [DE]
	[DE], A
	A, [HL]
	[HL], A
	A, [HL+byte]
	[HL+byte], A
	A, [HL+B]
	[HL+B], A
	A, [HL+C]
	[HL+C], A

Note Except r = A

[Flag]

PSW, #byte and PSW,
A operands

All other operand
combinations

Z	AC	CY
×	×	×

Z	AC	CY

[Description]

- The contents of the source operand (src) specified by the 2nd operand are transferred to the destination operand (dst) specified by the 1st operand.
- No interrupts are acknowledged between the MOV PSW, #byte instruction/MOV PSW, A instruction and the next instruction.

[Description example]

MOV A, #4DH; 4DH is transferred to the A register.

XCH**Exchange
Byte Data Exchange****[Instruction format]** **XCH dst, src****[Operation]** **dst ↔ src****[Operand]**

Mnemonic	Operand(dst,src)
XCH	A, r <small>Note</small>
	A, saddr
	A, sfr
	A, laddr16
	A, [DE]

Note Except r = A

Mnemonic	Operand(dst,src)
XCH	A, [HL]
	A, [HL+byte]
	A, [HL+B]
	A, [HL+C]

[Flag]

Z	AC	CY

[Description]

- The 1st and 2nd operand contents are exchanged.

[Description example]**XCH A, FEBCH;** The A register contents and address FEBCH contents are exchanged.

5.2 16-Bit Data Transfer Instructions

The following instructions are 16-bit data transfer instructions.

MOVW ... 52

XCHW ... 53

MOVW**Move Word
Word Data Transfer****[Instruction format]** **MOVW dst, src****[Operation]** **dst ← src****[Operand]**

Mnemonic	Operand(dst,src)
MOVW	rp, #word
	saddrp, #word
	sfrp, #word
	AX, saddrp
	saddrp, AX
	AX, sfrp

Mnemonic	Operand(dst,src)	
MOVW	sfrp, AX	
	AX, rp	Note
	rp, AX	Note
	AX, !addr16	
	!addr16, AX	

Note Only when rp = BC, DE or HL**[Flag]**

Z	AC	CY

[Description]

- The contents of the source operand (src) specified by the 2nd operand are transferred to the destination operand (dst) specified by the 1st operand.

[Description example]**MOVW AX, HL;** The HL register contents are transferred to the AX register.**[Caution]**

Only an even address can be specified. An odd address cannot be specified.

XCHWExchange Word
Word Data Exchange**[Instruction format]** **XCHW dst, src****[Operation]** **dst ↔ src****[Operand]**

Mnemonic	Operand(dst,src)
XCHW	AX, rp <small>Note</small>

Note Only when rp = BC, DE or HL**[Flag]**

Z	AC	CY

[Description]

- The 1st and 2nd operand contents are exchanged.

[Description example]**XCHW AX, BC;** The memory contents of the AX register are exchanged with those of the BC register.

5.3 8-Bit Operation Instructions

The following are 8-bit operation instructions.

ADD ... 55
ADDC ... 56
SUB ... 57
SUBC ... 58
AND ... 59
OR ... 60
XOR ... 61
CMP ... 62

ADD

Add
Byte Data Addition

[Instruction format] **ADD dst, src**

[Operation] **dst, CY ← dst + src**

[Operand]

Mnemonic	Operand(dst,src)
ADD	A, #byte
	saddr, #byte
	A, r Note
	r, A
	A, saddr

Note Except r = A

Mnemonic	Operand(dst,src)
ADD	A, !addr16
	A, [HL]
	A, [HL+byte]
	A, [HL+B]
	A, [HL+C]

[Flag]

Z	AC	CY
×	×	×

[Description]

- The destination operand (dst) specified by the 1st operand is added to the source operand (src) specified by the 2nd operand and the result is stored in the CY flag and the destination operand (dst).
- If the addition result shows that dst is 0, the Z flag is set (1). In all other cases, the Z flag is cleared (0).
- If the addition generates a carry out of bit 7, the CY flag is set (1). In all other cases, the CY flag is cleared (0).
- If the addition generates a carry for bit 4 out of bit 3, the AC flag is set (1). In all other cases, the AC flag is cleared (0).

[Description example]

ADD CR10, #56H; 56H is added to the CR10 register and the result is stored in the CR10 register.

ADDC

Add with Carry
Addition of Byte Data with Carry

[Instruction format] **ADDC dst, src**

[Operation] **dst, CY ← dst + src + CY**

[Operand]

Mnemonic	Operand(dst,src)
ADDC	A, #byte
	saddr, #byte
	A, r <small>Note</small>
	r, A
	A, saddr

Mnemonic	Operand(dst,src)
ADDC	A, laddr16
	A, [HL]
	A, [HL+byte]
	A, [HL+B]
	A, [HL+C]

Note Except r = A

[Flag]

Z	AC	CY
×	×	×

[Description]

- The destination operand (dst) specified by the 1st operand, the source operand (src) specified by the 2nd operand and the CY flag are added and the result is stored in the destination operand (dst) and the CY flag. The CY flag is added to the least significant bit. This instruction is mainly used to add two or more bytes.
- If the addition result shows that dst is 0, the Z flag is set (1). In all other cases, the Z flag is cleared (0).
- If the addition generates a carry out of bit 7, the CY flag is set (1). In all other cases, the CY flag is cleared (0).
- If the addition generates a carry for bit 4 out of bit 3, the AC flag is set (1). In all other cases, the AC flag is cleared (0).

[Description example]

ADDC A, [HL+B]; The A register contents and the contents at address (HL register + (B register)) and the CY flag are added and the result is stored in the A register.

SUB**Subtract
Byte Data Subtraction****[Instruction format]** **SUB dst, src****[Operation]** **dst, CY ← dst – src****[Operand]**

Mnemonic	Operand(dst,src)
SUB	A, #byte
	saddr, #byte
	A, r Note
	r, A
	A, saddr

Mnemonic	Operand(dst,src)
SUB	A, !addr16
	A, [HL]
	A, [HL+byte]
	A, [HL+B]
	A, [HL+C]

Note Except r = A**[Flag]**

Z	AC	CY
×	×	×

[Description]

- The source operand (src) specified by the 2nd operand is subtracted from the destination operand (dst) specified by the 1st operand and the result is stored in the destination operand (dst) and the CY flag. The destination operand can be cleared to 0 by equalizing the source operand (src) and the destination operand (dst).
- If the subtraction shows that dst is 0, the Z flag is set (1). In all other cases, the Z flag is cleared (0).
- If the subtraction generates a borrow out of bit 7, the CY flag is set (1). In all other cases, the CY flag is cleared (0).
- If the subtraction generates a borrow for bit 3 out of bit 4, the AC flag is set (1). In all other cases, the AC flag is cleared (0).

[Description example]**SUB D, A;** The A register is subtracted from the D register and the result is stored in the D register.

SUBC

Subtract with Carry
Subtraction of Byte Data with Carry

[Instruction format] **SUBC dst, src**

[Operation] **dst, CY ← dst – src – CY**

[Operand]

Mnemonic	Operand(dst,src)
SUBC	A, #byte
	saddr, #byte
	A, r Note
	r, A
	A, saddr

Mnemonic	Operand(dst,src)
SUBC	A, !addr16
	A, [HL]
	A, [HL+byte]
	A, [HL+B]
	A, [HL+C]

Note Except r = A

[Flag]

Z	AC	CY
×	×	×

[Description]

- The source operand (src) specified by the 2nd operand and the CY flag are subtracted from the destination operand (dst) specified by the 1st operand and the result is stored in the destination operand (dst). The CY flag is subtracted from the least significant bit. This instruction is mainly used for subtraction of two or more bytes.
- If the subtraction shows that dst is 0, the Z flag is set (1). In all other cases, the Z flag is cleared (0).
- If the subtraction generates a borrow out of bit 7, the CY flag is set (1). In all other cases, the CY flag is cleared (0).
- If the subtraction generates a borrow for bit 3 out of bit 4, the AC flag is set (1). In all other cases, the AC flag is cleared (0).

[Description example]

SUBC A, [HL]; The (HL register) address contents and the CY flag are subtracted from the A register and the result is stored in the A register.

AND

And
Logical Product of Byte Data

[Instruction format] **AND dst, src**

[Operation] **dst ← dst ∧ src**

[Operand]

Mnemonic	Operand(dst,src)
AND	A, #byte
	saddr, #byte
	A, r <small>Note</small>
	r, A
	A, saddr

Note Except r = A

Mnemonic	Operand(dst,src)
AND	A, !addr16
	A, [HL]
	A, [HL+byte]
	A, [HL+B]
	A, [HL+C]

[Flag]

Z	AC	CY
×		

[Description]

- Bit-wise logical product is obtained from the destination operand (dst) specified by the 1st operand and the source operand (src) specified by the 2nd operand and the result is stored in the destination operand (dst).
- If the logical product shows that all bits are 0, the Z flag is set (1). In all other cases, the Z flag is cleared (0).

[Description example]

AND FEBAH, #11011100B; Bit-wise logical product of FEBAH contents and 11011100B is obtained and the result is stored at FEBAH.

OR

Or
Logical Sum of Byte Data

[Instruction format] **OR dst, src**

[Operation] **dst ← dst ∨ src**

[Operand]

Mnemonic	Operand(dst,src)
OR	A, #byte
	saddr, #byte
	A, r Note
	r, A
	A, saddr

Mnemonic	Operand(dst,src)
OR	A, !addr16
	A, [HL]
	A, [HL+byte]
	A, [HL+B]
	A, [HL+C]

Note Except r = A

[Flag]

Z	AC	CY
×		

[Description]

- The bit-wise logical sum is obtained from the destination operand (dst) specified by the 1st operand and the source operand (src) specified by the 2nd operand and the result is stored in the destination operand (dst).
- If the logical sum shows that all bits are 0, the Z flag is set (1). In all other cases, the Z flag is cleared (0).

[Description example]

OR A, FE98H; The bit-wise logical sum of the A register and FE98H is obtained and the result is stored in the A register.

XOR

**Exclusive Or
Exclusive Logical Sum of Byte Data**

[Instruction format] **XOR dst, src**

[Operation] **dst ← dst ∨ src**

[Operand]

Mnemonic	Operand(dst,src)
XOR	A, #byte
	saddr, #byte
	A, r <small>Note</small>
	r, A
	A, saddr

Mnemonic	Operand(dst,src)
XOR	A, !addr16
	A, [HL]
	A, [HL+byte]
	A, [HL+B]
	A, [HL+C]

Note Except r = A

[Flag]

Z	AC	CY
×		

[Description]

- The bit-wise exclusive logical sum is obtained from the destination operand (dst) specified by the 1st operand and the source operand (src) specified by the 2nd operand and the result is stored in the destination operand (dst).
Logical negation of all bits of the destination operand (dst) is possible by selecting #0FFH for the source operand (src) with this instruction.
- If the exclusive logical sum shows that all bits are 0, the Z flag is set (1). In all other cases, the Z flag is cleared (0).

[Description example]

XOR A, L; The bit-wise exclusive logical sum of the A and L registers is obtained and the result is stored in the A register.

CMP**Compare
Byte Data Comparison****[Instruction format]** **CMP dst, src****[Operation]** **dst – src****[Operand]**

Mnemonic	Operand(dst,src)
CMP	A, #byte
	saddr, #byte
	A, r Note
	r, A
	A, saddr

Mnemonic	Operand(dst,src)
CMP	A, !addr16
	A, [HL]
	A, [HL+byte]
	A, [HL+B]
	A, [HL+C]

Note Except r = A**[Flag]**

Z	AC	CY
×	×	×

[Description]

- The source operand (src) specified by the 2nd operand is subtracted from the destination operand (dst) specified by the 1st operand.

The subtraction result is not stored anywhere and only the Z, AC and CY flags are changed.

- If the subtraction result is 0, the Z flag is set (1). In all other cases, the Z flag is cleared (0).
- If the subtraction generates a borrow out of bit 7, the CY flag is set (1). In all other cases, the CY flag is cleared (0).
- If the subtraction generates a borrow for bit 3 out of bit 4, the AC flag is set (1). In all other cases, the AC flag is cleared (0).

[Description example]

CMP FE38H, #38H; 38H is subtracted from the contents at address FE38H and only the flags are changed (comparison of contents at address FE38H and the immediate data).

5.4 16-Bit Operation Instructions

The following are 16-bit operation instructions.

ADDW ... 64

SUBW ... 65

CMPW ... 66

ADDW**Add Word
Word Data Addition****[Instruction format]** **ADDW dst, src****[Operation]** **dst, CY ← dst + src****[Operand]**

Mnemonic	Operand(dst,src)
ADDW	AX, #word

[Flag]

Z	AC	CY
×	×	×

[Description]

- The destination operand (dst) specified by the 1st operand is added to the source operand (src) specified by the 2nd operand and the result is stored in the destination operand (dst).
- If the addition result shows that dst is 0, the Z flag is set (1). In all other cases, the Z flag is cleared (0).
- If the addition generates a carry out of bit 15, the CY flag is set (1). In all other cases, the CY flag is cleared (0).
- As a result of addition, the AC flag becomes undefined.

[Description example]**ADDW AX, #ABCDH;** ABCDH is added to the AX register and the result is stored in the AX register.

SUBW

Subtract Word
Word Data Subtraction

[Instruction format] **SUBW dst, src**

[Operation] **dst, CY ← dst – src**

[Operand]

Mnemonic	Operand(dst,src)
SUBW	AX, #word

[Flag]

Z	AC	CY
×	×	×

[Description]

- The source operand (src) specified by the 2nd operand is subtracted from the destination operand (dst) specified by the 1st operand and the result is stored in the destination operand (dst) and the CY flag. The destination operand can be cleared to 0 by equalizing the source operand (src) and the destination operand (dst).
- If the subtraction shows that dst is 0, the Z flag is set (1). In all other cases, the Z flag is cleared (0).
- If the subtraction generates a borrow out of bit 15, the CY flag is set (1). In all other cases, the CY flag is cleared (0).
- As a result of subtraction, the AC flag becomes undefined.

[Description example]

SUBW AX, #ABCDH; ABCDH is subtracted from the AX register contents and the result is stored in the AX register.

CMPW

**Compare Word
Word Data Comparison**

[Instruction format] **CMPW dst, src**

[Operation] **dst – src**

[Operand]

Mnemonic	Operand(dst,src)
CMPW	AX, #word

[Flag]

Z	AC	CY
×	×	×

[Description]

- The source operand (src) specified by the 2nd operand is subtracted from the destination operand (dst) specified by the 1st operand.
The subtraction result is not stored anywhere and only the Z, AC and CY flags are changed.
- If the subtraction result is 0, the Z flag is set (1). In all other cases, the Z flag is cleared (0).
- If the subtraction generates a borrow out of bit 15, the CY flag is set (1). In all other cases, the CY flag is cleared (0).
- As a result of subtraction, the AC flag becomes undefined.

[Description example]

CMPW AX, #ABCDH; ABCDH is subtracted from the AX register and only the flags are changed (comparison of the AX register and the immediate data).

5.5 Multiply/Divide Instructions

The following are multiply/divide instructions.

MULU ... 68
DIVUW ... 69

MULU

**Multiply Unsigned
Unsigned Multiplication of Data**

[Instruction format] **MULU src**

[Operation] **AX ← A × src**

[Operand]

Mnemonic	Operand(src)
MULU	X

[Flag]

Z	AC	CY

[Description]

- The A register contents and the source operand (src) data are multiplied as unsigned data and the result is stored in the AX register.

[Description example]

MULU X; The A register contents and the X register contents are multiplied and the result is stored in the AX register.

DIVUW

Divide Unsigned Word
Unsigned Division of Word Data

[Instruction format] **DIVUW dst**

[Operation] **AX (quotient), dst (remainder) ← AX ÷ dst**

[Operand]

Mnemonic	Operand(dst)
DIVUW	C

[Flag]

Z	AC	CY

[Description]

- The AX register contents are divided by the destination operand (dst) contents and the quotient and the remainder are stored in the AX register and the destination operand (dst), respectively. Division is executed using the AX register and destination operand (dst) contents as unsigned data. However, when the destination operand (dst) is 0, the X register contents are stored in the C register and AX becomes 0FFFFH.

[Description example]

DIVUW C; The AX register contents are divided by the C register contents and the quotient and the remainder are stored in the AX register and the C register, respectively.

5.6 Increment/Decrement Instructions

The following are increment/decrement instructions.

INC ... 71

DEC ... 72

INCW ... 73

DECW ... 74

INC

Increment
Byte Data Increment

[Instruction format] **INC dst**

[Operation] **dst ← dst + 1**

[Operand]

Mnemonic	Operand(dst)
INC	r
	saddr

[Flag]

Z	AC	CY
×	×	

[Description]

- The destination operand (dst) contents are incremented by only one.
- If the increment result is 0, the Z flag is set (1). In all other cases, the Z flag is cleared (0).
- If the increment generates a carry for bit 4 out of bit 3, the AC flag is set (1). In all other cases, the AC flag is cleared (0).
- Because this instruction is frequently used for increment of a counter for repeated operations and an indexed addressing offset register, the CY flag contents are not changed (to hold the CY flag contents in multiple-byte operation).

[Description example]

INC B; The B register is incremented.

DEC

**Decrement
Byte Data Decrement**

[Instruction format] **DEC dst**

[Operation] **dst ← dst – 1**

[Operand]

Mnemonic	Operand(dst)
DEC	r
	saddr

[Flag]

Z	AC	CY
×	×	

[Description]

- The destination operand (dst) contents are decremented by only one.
- If the decrement result is 0, the Z flag is set (1). In all other cases, the Z flag is cleared (0).
- If the decrement generates a carry for bit 3 out of bit 4, the AC flag is set (1). In all other cases, the AC flag is cleared (0).
- Because this instruction is frequently used for decrement of a counter for repeated operations and an indexed addressing offset register, the CY flag contents are not changed (to hold the CY flag contents in multiple-byte operation).
- If dst is the B or C register or saddr, and it is not desired to change the AC and CY flag contents, the DBNZ instruction can be used.

[Description example]

DEC FE92H; The contents at address FE92H are decremented.

INCW

**Increment Word
Word Data Increment**

[Instruction format] **INCW dst**

[Operation] **dst ← dst + 1**

[Operand]

Mnemonic	Operand(dst)
INCW	rp

[Flag]

Z	AC	CY

[Description]

- The destination operand (dst) contents are incremented by only one.
- Because this instruction is frequently used for increment of a register (pointer) used for addressing, the Z, AC and CY flag contents are not changed.

[Description example]

INCW HL; The HL register is incremented.

DECW

**Decrement Word
Word Data Decrement**

[Instruction format] **DECW dst**

[Operation] **dst ← dst – 1**

[Operand]

Mnemonic	Operand (dst)
DECW	rp

[Flag]

Z	AC	CY

[Description]

- The destination operand (dst) contents are decremented by only one.
- Because this instruction is frequently used for decrement of a register (pointer) used for addressing, the Z, AC and CY flag contents are not changed.

[Description example]

DECW DE; The DE register is decremented.

5.7 Rotate Instructions

The following are rotate instructions.

ROR ... 76

ROL ... 77

RORC ... 78

ROLC ... 79

ROR4 ... 80

ROL4 ... 81

ROR

Rotate Right
Byte Data Rotation to the Right

[Instruction format] **ROR dst, cnt**

[Operation] **(CY, dst₇ ← dst₀, dst_{m-1} ← dst_m) × one time**

[Operand]

Mnemonic	Operand(dst,cnt)
ROR	A, 1

[Flag]

Z	AC	CY
		×

[Description]

- The destination operand (dst) contents specified by the 1st operand are rotated to the right just once.
- The LSB (bit 0) contents are simultaneously rotated to MSB (bit 7) and transferred to the CY flag.

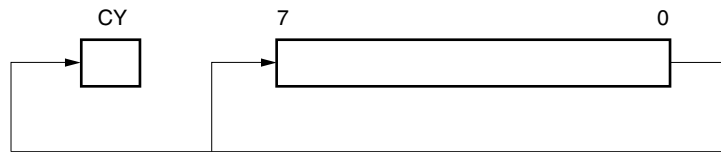

[Description example]

ROR A, 1; The A register contents are rotated one bit to the right.

ROL

Rotate Left
Byte Data Rotation to the Left

[Instruction format] **ROL dst, cnt**

[Operation] **(CY, dst₀ ← dst₇, dst_{m+1} ← dst_m) × one time**

[Operand]

Mnemonic	Operand(dst,cnt)
ROL	A, 1

[Flag]

Z	AC	CY
		×

[Description]

- The destination operand (dst) contents specified by the 1st operand are rotated to the left just once.
- The MSB (bit 7) contents are simultaneously rotated to LSB (bit 0) and transferred to the CY flag.

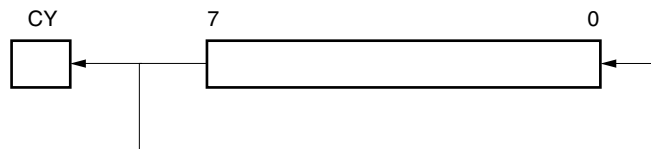

[Description example]

ROL A, 1; The A register contents are rotated to the left by one bit.

RORC

Rotate Right with Carry
Byte Data Rotation to the Right with Carry

[Instruction format] **RORC dst, cnt**

[Operation] **(CY ← dst₀, dst₇ ← CY, dst_{m-1} ← dst_m) × one time**

[Operand]

Mnemonic	Operand(dst,cnt)
RORC	A, 1

[Flag]

Z	AC	CY
		×

[Description]

- The destination operand (dst) contents specified by the 1st operand are rotated just once to the right with carry.

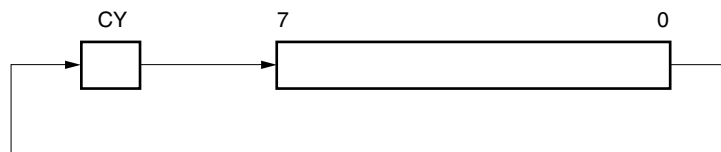

[Description example]

RORC A, 1; The A register contents are rotated to the right by one bit including the CY flag.

ROLC

Rotate Left with Carry
Byte Data Rotation to the Left with Carry

[Instruction format] **ROLC dst, cnt**

[Operation] **(CY ← dst₇, dst₀ ← CY, dst_{m+1} ← dst_m) × one time**

[Operand]

Mnemonic	Operand(dst,cnt)
ROLC	A, 1

[Flag]

Z	AC	CY
		×

[Description]

- The destination operand (dst) contents specified by the 1st operand are rotated just once to the left with carry.

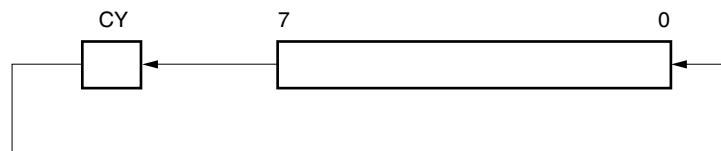

[Description example]

ROLC A, 1; The A register contents are rotated to the left by one bit including the CY flag.

ROR4

Rotate Right Digit
Digit Rotation to the Right

[Instruction format] ROR4 dst

[Operation] $A_{3-0} \leftarrow (dst)_{3-0}, (dst)_{7-4} \leftarrow A_{3-0}, (dst)_{3-0} \leftarrow (dst)_{7-4}$

[Operand]

Mnemonic	Operand(dst)
ROR4	[HL] Note

Note Specify an area other than the SFR area as operand [HL].

[Flag]

Z	AC	CY

[Description]

- The lower 4 bits of the A register and the 2-digit data (4-bit data) of the destination operand (dst) are rotated to the right.

The higher 4 bits of the A register remain unchanged.

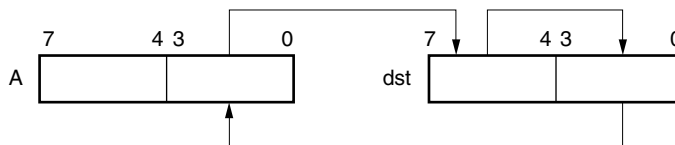

[Description example]

ROR4 [HL]; Rightward digit rotation is executed with the memory contents specified by the A and HL registers.

	A				(HL)			
	7	4	3	0	7	4	3	0
Before Execution	1	0	1	0	0	0	1	1
After Execution	1	0	1	0	0	0	1	1

ROL4

Rotate Left Digit
Digit Rotation to the Left

[Instruction format] ROL4 dst

[Operation] $A_{3-0} \leftarrow (dst)_{7-4}, (dst)_{3-0} \leftarrow A_{3-0}, (dst)_{7-4} \leftarrow (dst)_{3-0}$

[Operand]

Mnemonic	Operand(dst)
ROL4	[HL] Note

Note Specify an area other than the SFR area as operand [HL].

[Flag]

Z	AC	CY

[Description]

- The lower 4 bits of the A register and the 2-digit data (4-bit data) of the destination operand (dst) are rotated to the left.
- The higher 4 bits of the A register remain unchanged.

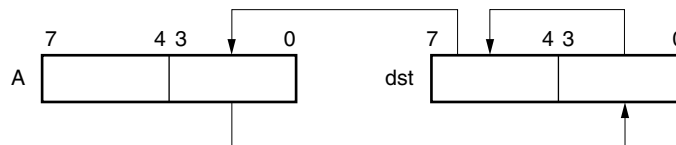

[Description example]

ROL4 [HL]; Leftward digit rotation is executed with the memory contents specified by the A and HL registers.

	A				(HL)			
	7	4	3	0	7	4	3	0
Before Execution	0001		0010		0100		1000	
After Execution	0001		0100		1000		0010	

5.8 BCD Adjust Instructions

The following are BCD adjust instructions.

ADJBA ... 83

ADJBS ... 84

ADJBA

**Decimal Adjust Register for Addition
Decimal Adjustment of Addition Result**

[Instruction format] ADJBA

[Operation] Decimal Adjust Accumulator for Addition

[Operand]

None

[Flag]

Z	AC	CY
×	×	×

[Description]

- The A register, CY flag and AC flag are decimally adjusted from their contents. This instruction carries out an operation having meaning only when the BCD (binary coded decimal) data is added and the addition result is stored in the A register (in all other cases, the instruction carries out an operation having no meaning). See the table below for the adjustment method.
- If the adjustment result shows that the A register contents are 0, the Z flag is set (1). In all other cases, the Z flag is cleared (0).

Condition		Operation
A ₃ to A ₀ ≤ 9	A ₇ to A ₄ ≤ 9 and CY = 0	A ← A, CY ← 0, AC ← 0
AC = 0	A ₇ to A ₄ ≥ 10 or CY = 1	A ← A+01100000B, CY ← 1, AC ← 0
A ₃ to A ₀ ≥ 10	A ₇ to A ₄ < 9 and CY = 0	A ← A+00000110B, CY ← 0, AC ← 1
AC = 0	A ₇ to A ₄ ≥ 9 or CY = 1	A ← A+01100110B, CY ← 1, AC ← 1
AC = 1	A ₇ to A ₄ ≤ 9 and CY = 0	A ← A+00000110B, CY ← 0, AC ← 0
	A ₇ to A ₄ ≥ 10 or CY = 1	A ← A+01100110B, CY ← 1, AC ← 0

ADJBS

**Decimal Adjust Register for Subtraction
Decimal Adjustment of Subtraction Result**

[Instruction format] **ADJBS**

[Operation] **Decimal Adjust Accumulator for Subtraction**

[Operand]

None

[Flag]

Z	AC	CY
x	x	x

[Description]

- The A register, CY flag and AC flag are decimally adjusted from their contents. This instruction carries out an operation having meaning only when the BCD (binary coded decimal) data is subtracted and the subtraction result is stored in the A register (in all other cases, the instruction carries out an operation having no meaning).

See the table below for the adjustment method.

- If the adjustment result shows that the A register contents are 0, the Z flag is set (1). In all other cases, the Z flag is cleared (0).

Condition		Operation
AC = 0	CY = 0	$A \leftarrow A, CY \leftarrow 0, AC \leftarrow 0$
	CY = 1	$A \leftarrow A-01100000B, CY \leftarrow 1, AC \leftarrow 0$
AC = 1	CY = 0	$A \leftarrow A-00000110B, CY \leftarrow 0, AC \leftarrow 0$
	CY = 1	$A \leftarrow A-01100110B, CY \leftarrow 1, AC \leftarrow 0$

5.9 Bit Manipulation Instructions

The following are bit manipulation instructions.

MOV1 ... 86

AND1 ... 87

OR1 ... 88

XOR1 ... 89

SET1 ... 90

CLR1 ... 91

NOT1 ... 92

MOV1

Move Single Bit
1 Bit Data Transfer

[Instruction format] **MOV1 dst, src**

[Operation] **dst ← src**

[Operand]

Mnemonic	Operand(dst,src)
MOV1	CY, saddr.bit
	CY, sfr.bit
	CY, A.bit
	CY, PSW.bit
	CY, [HL].bit

Mnemonic	Operand(dst,src)
MOV1	saddr.bit, CY
	sfr.bit, CY
	A.bit, CY
	PSW.bit, CY
	[HL].bit, CY

[Flag]

dst = CY

Z	AC	CY
		×

PSW.bit

Z	AC	CY
×	×	

In all other cases

Z	AC	CY

[Description]

- Bit data of the source operand (src) specified by the 2nd operand is transferred to the destination operand (dst) specified by the 1st operand.
- When the destination operand (dst) is CY or PSW.bit, only the corresponding flag is changed.

[Description example]

MOV1 P3.4, CY; The CY flag contents are transferred to bit 4 of port 3.

AND1

**And Single Bit
1 Bit Data Logical Product**

[Instruction format] **AND1 dst, src**

[Operation] **dst ← dst ∧ src**

[Operand]

Mnemonic	Operand(dst,src)
AND1	CY, saddr.bit
	CY, sfr.bit
	CY, A.bit
	CY, PSW.bit
	CY, [HL].bit

[Flag]

Z	AC	CY
		×

[Description]

- Logical product of bit data of the destination operand (dst) specified by the 1st operand and the source operand (src) specified by the 2nd operand is obtained and the result is stored in the destination operand (dst).
- The operation result is stored in the CY flag (because of the destination operand (dst)).

[Description example]

AND1 CY, FE7FH.3; Logical product of FE7FH bit 3 and the CY flag is obtained and the result is stored in the CY flag.

OR1

**Or Single Bit
1 Bit Data Logical Sum**

[Instruction format] **OR1 dst, src**

[Operation] **dst ← dst ∨ src**

[Operand]

Mnemonic	Operand(dst,src)
OR1	CY, saddr.bit
	CY, sfr.bit
	CY, A.bit
	CY, PSW.bit
	CY, [HL].bit

[Flag]

Z	AC	CY
		×

[Description]

- The logical sum of bit data of the destination operand (dst) specified by the 1st operand and the source operand (src) specified by the 2nd operand is obtained and the result is stored in the destination operand (dst).
- The operation result is stored in the CY flag (because of the destination operand (dst)).

[Description example]

OR1 CY, P2.5; The logical sum of port 2 bit 5 and the CY flag is obtained and the result is stored in the CY flag.

XOR1

**Exclusive Or Single Bit
1 Bit Data Exclusive Logical Sum**

[Instruction format] **XOR1 dst, src**

[Operation] **dst ← dst ∨ src**

[Operand]

Mnemonic	Operand(dst,src)
XOR1	CY, saddr.bit
	CY, sfr.bit
	CY, A.bit
	CY, PSW.bit
	CY, [HL].bit

[Flag]

Z	AC	CY
		×

[Description]

- The exclusive logical sum of bit data of the destination operand (dst) specified by the 1st operand and the source operand (src) specified by the 2nd operand is obtained and the result is stored in the destination operand (dst).
- The operation result is stored in the CY flag (because of the destination operand (dst)).

[Description example]

XOR1 CY, A.7; The exclusive logical sum of the A register bit 7 and the CY flag is obtained and the result is stored in the CY flag.

SET1

Set Single Bit (Carry Flag)
1 Bit Data Set

[Instruction format] **SET1 dst**

[Operation] **dst ← 1**

[Operand]

Mnemonic	Operand(dst)
SET1	saddr.bit
	sfr.bit
	A.bit
	PSW.bit
	[HL].bit
	CY

[Flag]

dst = PSW.bit

Z	AC	CY
×	×	×

dst = CY

Z	AC	CY
		1

In all other cases

Z	AC	CY

[Description]

- The destination operand (dst) is set (1).
- When the destination operand (dst) is CY or PSW.bit, only the corresponding flag is set (1).

[Description example]

SET1 FE55H.1; Bit 1 of FE55H is set (1).

CLR1

Clear Single Bit (Carry Flag)
1 Bit Data Clear

[Instruction format] **CLR1 dst**

[Operation] **dst ← 0**

[Operand]

Mnemonic	Operand(dst)
CLR1	saddr.bit
	sfr.bit
	A.bit
	PSW.bit
	[HL].bit
	CY

[Flag]

dst = PSW.bit

Z	AC	CY
×	×	×

dst = CY

Z	AC	CY
		0

In all other cases

Z	AC	CY

[Description]

- The destination operand (dst) is cleared (0).
- When the destination operand (dst) is CY or PSW.bit, only the corresponding flag is cleared (0).

[Description example]

CLR1 P3.7; Bit 7 of port 3 is cleared (0).

NOT1

Not Single Bit (Carry Flag)
1 Bit Data Logical Negation

[Instruction format] **NOT1 dst**

[Operation] **dst ← $\overline{\text{dst}}$**

[Operand]

Mnemonic	Operand(dst)
NOT1	CY

[Flag]

Z	AC	CY
		×

[Description]

- The CY flag is inverted.

[Description example]

NOT1 CY; The CY flag is inverted.

5.10 Call Return Instructions

The following are call return instructions.

CALL ... 94
CALLF ... 95
CALLT ... 96
BRK ... 97
RET ... 98
RETI ... 99
RETB ... 100

CALL

Call
Subroutine Call (16 Bit Direct)

[Instruction format] **CALL target**

[Operation] **(SP-1) ← (PC+3)_H,**
 (SP-2) ← (PC+3)_L,
 SP ← SP-2,
 PC ← target

[Operand]

Mnemonic	Operand(target)
CALL	!addr16

[Flag]

Z	AC	CY

[Description]

- This is a subroutine call with a 16-bit absolute address or a register indirect address.
- The start address (PC+3) of the next instruction is saved in the stack and is branched to the address specified by the target operand (target).

[Description example]

CALL !3059H; Subroutine call to 3059H

CALLF

Call Flag

Subroutine Call (11 Bit Direct Specification)

[Instruction format] **CALLF Target**

[Operation] **(SP-1) ← (PC+2)_H,**
 (SP-2) ← (PC+2)_L,
 SP ← SP-2,
 PC ← target

[Operand]

Mnemonic	Operand(target)
CALLF	!addr11

[Flag]

Z	AC	CY

[Description]

- This is a subroutine call which can only be branched to addresses 0800H to 0FFFH.
- The start address (PC+2) of the next instruction is saved in the stack and is branched in the range of addresses 0800H to 0FFFH.
- Only the lower 11 bits of an address are specified (with the higher 5 bits fixed to 00001B).
- The program size can be compressed by locating the subroutine at 0800H to 0FFFH and using this instruction. If the program is in the external memory, the execution time can be decreased.

[Description example]**CALLF !0C2AH;** Subroutine call to 0C2AH

CALLT

Call Table

Subroutine Call (Refer to the Call Table)

[Instruction format] **CALLT [addr5]**

[Operation]

$$\begin{aligned} (\text{SP}-1) &\leftarrow (\text{PC}+1)_H, \\ (\text{SP}-2) &\leftarrow (\text{PC}+1)_L, \\ \text{SP} &\leftarrow \text{SP}-2, \\ \text{PC}_H &\leftarrow (00000000, \text{addr5}+1) \\ \text{PC}_L &\leftarrow (00000000, \text{addr5}) \end{aligned}$$
[Operand]

Mnemonic	Operand([addr5])
CALLT	[addr5]

[Flag]

Z	AC	CY

[Description]

- This is a subroutine call for call table reference.
- The start address (PC+1) of the next instruction is saved in the stack and is branched to the address indicated with the word data of a call table (the higher 8 bits of address are fixed to 00000000B and the next 5 bits are specified by addr5).

[Description example]

CALLT [40H]; Subroutine call to the word data addresses 0040H and 0041H.

BRK

Break
Software Vectored Interrupt

[Instruction format] **BRK**

[Operation] **(SP-1) ← PSW,**
(SP-2) ← (PC+1)_H,
(SP-3) ← (PC+1)_L,
IE ← 0,
SP ← SP-3,
PC_H ← (3FH),
PC_L ← (3EH)

[Operand]

None

[Flag]

Z	AC	CY

[Description]

- This is a software interrupt instruction.
- PSW and the next instruction address (PC+1) are saved to the stack. After that, the IE flag is cleared (0) and the saved data is branched to the address indicated with the word data at the vector address (003EH). Because the IE flag is cleared (0), the subsequent maskable vectored interrupts are disabled.
- The RETB instruction is used to return from the software vectored interrupt generated with this instruction.

RET**Return**
Return from Subroutine**[Instruction format]** **RET****[Operation]** **PC_L ← (SP),**
 PC_H ← (SP+1),
 SP ← SP+2**[Operand]**

None

[Flag]

Z	AC	CY

[Description]

- This is a return instruction from the subroutine call made with the CALL, CALLF and CALLT instructions.
- The word data saved to the stack returns to the PC, and the program returns from the subroutine.

RETI

Return from Interrupt
Return from Hardware Vectored Interrupt

[Instruction format] **RETI**

[Operation] **PCL** ← **(SP)**,
PC_H ← **(SP+1)**,
PSW ← **(SP+2)**,
SP ← **SP+3**,
NMIS ← **0**

[Operand]

None

[Flag]

Z	AC	CY
R	R	R

[Description]

- This is a return instruction from the vectored interrupt.
- The data saved to the stack returns to the PC and the PSW, and the program returns from the interrupt service routine.
- This instruction cannot be used for return from the software interrupt with the BRK instruction.
- None of interrupts are acknowledged between this instruction and the next instruction to be executed.
- The NMIS flag is set to 1 by acknowledgment of a non-maskable interrupt, and cleared to 0 by the RETI instruction.

[Caution]

When the return from non-maskable interrupt servicing is performed by an instruction other than the RETI instruction, the NMIS flag is not cleared to 0, and therefore no interrupts (including non-maskable interrupts) except software interrupts can be acknowledged.

RETB

Return from Break
Return from Software Vectored Interrupt

[Instruction format] **RETB**

[Operation] **PC_L ← (SP),**
PC_H ← (SP+1),
PSW ← (SP+2),
SP ← SP+3

[Operand]
 None

[Flag]

Z	AC	CY
R	R	R

[Description]

- This is a return instruction from the software interrupt generated with the BRK instruction.
- The data saved in the stack returns to the PC and the PSW, and the program returns from the interrupt service routine.
- None of interrupts are acknowledged between this instruction and the next instruction to be executed.

5.11 Stack Manipulation Instructions

The following are stack manipulation instructions.

PUSH ... 102

POP ... 103

MOVW SP, src ... 104

MOVW AX, SP ... 104

PUSH

Push
Push

[Instruction format] **PUSH src**

[Operation]	When src = rp	When src = PSW
	(SP-1) ← srcH, (SP-2) ← srcL, SP ← SP-2	(SP-1) ← src SP ← SP-1

[Operand]

Mnemonic	Operand(src)
PUSH	PSW
	rp

[Flag]

Z	AC	CY

[Description]

- The data of the register specified by the source operand (src) is saved to the stack.

[Description example]

PUSH AX; AX register contents are saved to the stack.

POP	Pop Pop
------------	------------

[Instruction format] **POP dst**

[Operation]	When dst = rp	When dst = PSW
	dst_L ← (SP),	dst ← (SP)
	dst_H ← (SP+1),	SP ← SP+1
	SP ← SP+2	

[Operand]

Mnemonic	Operand(dst)
POP	PSW
	rp

[Flag]

dst =rp

Z	AC	CY

PSW

Z	AC	CY
R	R	R

[Description]

- Data is returned from the stack to the register specified by the destination operand (dst).
- When the operand is PSW, each flag is replaced with stack data.
- None of interrupts are acknowledged between the POP PSW instruction and the subsequent instruction.

[Description example]

POP AX; The stack data is returned to the AX register.

MOVW SP, src

MOVW AX, SP

Move Word
Word Data Transfer with Stack Pointer

[Instruction format] **MOVW dst, src**

[Operation] **dst ← src**

[Operand]

Mnemonic	Operand(dst,src)
MOVW	SP, #word
	SP, AX
	AX, SP

[Flag]

Z	AC	CY

[Description]

- This is an instruction to manipulate the stack pointer contents.
- The source operand (src) specified by the 2nd operand is stored in the destination operand (dst) specified by the 1st operand.

[Description example]

MOVW SP, #FE1FH; FE1FH is stored in the stack pointer.

5.12 Unconditional Branch Instruction

The unconditional branch instruction is shown below.

BR ... 106

BR**Branch
Unconditional Branch****[Instruction format]** **BR target****[Operation]** **PC ← target****[Operand]**

Mnemonic	Operand(target)
BR	!addr16
	AX
	\$addr16

[Flag]

Z	AC	CY

[Description]

- This is an instruction to branch unconditionally.
- The word data of the target address operand (target) is transferred to PC and branched.

[Description example]**BR AX;** The AX register contents are branched as the address.

5.13 Conditional Branch Instructions

Conditional branch instructions are shown below.

BC ... 108
BNC ... 109
BZ ... 110
BNZ ... 111
BT ... 112
BF ... 113
BTCLR ... 114
DBNZ ... 115

BC**Branch if Carry
Conditional Branch with Carry Flag (CY = 1)****[Instruction format]** **BC \$addr16****[Operation]** **PC ← PC+2+jdisp8 if CY = 1****[Operand]**

Mnemonic	Operand(\$addr16)
BC	\$addr16

[Flag]

Z	AC	CY

[Description]

- When CY = 1, data is branched to the address specified by the operand.
When CY = 0, no processing is carried out and the subsequent instruction is executed.

[Description example]

BC \$300H; When CY = 1, data is branched to 0300H (with the start of this instruction set in the range of addresses 027FH to 037EH).

BNC

Branch if Not Carry
Conditional Branch with Carry Flag (CY = 0)

[Instruction format] **BNC \$addr16**

[Operation] **PC ← PC+2+jdisp8 if CY = 0**

[Operand]

Mnemonic	Operand(\$addr16)
BNC	\$addr16

[Flag]

Z	AC	CY

[Description]

- When CY = 0, data is branched to the address specified by the operand.
When CY = 1, no processing is carried out and the subsequent instruction is executed.

[Description example]

BNC \$300H; When CY = 0, data is branched to 0300H (with the start of this instruction set in the range of addresses 027FH to 037EH).

BZ

Branch if Zero
Conditional Branch with Zero Flag (Z = 1)

[Instruction format] **BZ \$addr16**

[Operation] **PC ← PC+2+jdisp8 if Z = 1**

[Operand]

Mnemonic	Operand(\$addr16)
BZ	\$addr16

[Flag]

Z	AC	CY

[Description]

- When Z = 1, data is branched to the address specified by the operand.
When Z = 0, no processing is carried out and the subsequent instruction is executed.

[Description example]

DEC B

BZ \$3C5H; When the B register is 0, data is branched to 03C5H (with the start of this instruction set in the range of addresses 0344H to 0443H).

BNZ

Branch if Not Zero
Conditional Branch with Zero Flag (Z = 0)

[Instruction format] **BNZ \$addr16**

[Operation] **PC ← PC+2+jdisp8 if Z = 0**

[Operand]

Mnemonic	Operand(\$addr16)
BNZ	\$addr16

[Flag]

Z	AC	CY

[Description]

- When Z = 0, data is branched to the address specified by the operand.
When Z = 1, no processing is carried out and the subsequent instruction is executed.

[Description example]

CMP A, #55H

BNZ \$0A39H; If the A register is not 0055H, data is branched to 0A39H (with the start of this instruction set in the range of addresses 09B8H to 0AB7H).

BT**Branch if True****Conditional Branch by Bit Test (Byte Data Bit = 1)****[Instruction format]** BT bit, \$addr16**[Operation]** PC ← PC+b+jdisp8 if bit = 1**[Operand]**

Mnemonic	Operand(bit,\$addr16)	b(Number of bytes)
BT	saddr.bit, \$addr16	3
	sfr.bit, \$addr16	4
	A.bit, \$addr16	3
	PSW.bit, \$addr16	3
	[HL].bit, \$addr16	3

[Flag]

Z	AC	CY

[Description]

- If the 1st operand (bit) contents have been set (1), data is branched to the address specified by the 2nd operand (\$addr16).
If the 1st operand (bit) contents have not been set (0), no processing is carried out and the subsequent instruction is executed.

[Description example]

BT FE47H.3, \$55CH; When bit 3 at address FE47H is 1, data is branched to 055CH (with the start of this instruction set in the range of addresses 04DAH to 05D9H).

BF**Branch if False**
Conditional Branch by Bit Test (Byte Data Bit = 0)**[Instruction format]** **BF bit, \$addr16****[Operation]** **PC ← PC+b+jdisp8 if bit = 0****[Operand]**

Mnemonic	Operand(bit,\$addr16)	b(Number of bytes)
BF	saddr.bit, \$addr16	4
	sfr.bit, \$addr16	4
	A.bit, \$addr16	3
	PSW.bit, \$addr16	4
	[HL].bit, \$addr16	3

[Flag]

Z	AC	CY

[Description]

- If the 1st operand (bit) contents have been cleared (0), data is branched to the address specified by the 2nd operand (\$addr16).
If the 1st operand (bit) contents have not been cleared (0), no processing is carried out and the subsequent instruction is executed.

[Description example]

BF P2.2, \$1549H; When bit 2 of port 2 is 0, data is branched to address 1549H (with the start of this instruction set in the range of addresses 14C6H to 15C5H).

BTCLR

Branch if True and Clear
Conditional Branch and Clear by Bit Test (Byte Data Bit = 1)

[Instruction format] **BTCLR bit, \$addr16**

[Operation] **PC ← PC+b+jdisp8 if bit = 1, then bit ← 0**

[Operand]

Mnemonic	Operand(bit,\$addr16)	b(Number of bytes)
BTCLR	saddr.bit, \$addr16	4
	sfr.bit, \$addr16	4
	A.bit, \$addr16	3
	PSW.bit, \$addr16	4
	[HL].bit, \$addr16	3

[Flag]

bit =PSW.bit

Z	AC	CY
×	×	×

In all other cases

Z	AC	CY

[Description]

- If the 1st operand (bit) contents have been set (1), they are cleared (0) and branched to the address specified by the 2nd operand.
If the 1st operand (bit) contents have not been set (1), no processing is carried out and the subsequent instruction is executed.
- When the 1st operand (bit) is PSW.bit, the corresponding flag contents are cleared (0).

[Description example]

BTCLR PSW.0, \$356H; When bit 0 (CY flag) of PSW is 1, the CY flag is cleared to 0 and branched to address 0356H (with the start of this instruction set in the range of addresses 02D4H to 03D3H).

DBNZ

Decrement and Branch if Not Zero
Conditional Loop (R1 ≠ 0)

[Instruction format] **DBNZ dst, \$addr16**

[Operation] **dst ← dst−1,**
 then PC ← PC+b+jdisp16 if dst R1 ≠ 0

[Operand]

Mnemonic	Operand(dst,\$addr16)	b(Number of bytes)
DBNZ	B, \$addr16	2
	C, \$addr16	2
	saddr, \$addr16	3

[Flag]

Z	AC	CY

[Description]

- One is subtracted from the destination operand (dst) contents specified by the 1st operand and the subtraction result is stored in the destination operand (dst).
- If the subtraction result is not 0, data is branched to the address indicated with the 2nd operand (\$addr16). When the subtraction result is 0, no processing is carried out and the subsequent instruction is executed.
- The flag remains unchanged.

[Description example]

DBNZ B, \$1215H; The B register contents are decremented. If the result is not 0, data is branched to 1215H (with the start of this instruction set in the range of addresses 1194H to 1293H).

5.14 CPU Control Instructions

The following are CPU control instructions.

SEL RBn ... 117

NOP ... 118

EI ... 119

DI ... 120

HALT ... 121

STOP ... 122

SEL RBn

**Select Register Bank
Register Bank Selection**

[Instruction format] **SEL RBn**

[Operation] **RBS0, RBS1 ← n; (n = 0-3)**

[Operand]

Mnemonic	Operand(RBn)
SEL	RBn

[Flag]

Z	AC	CY

[Description]

- The register bank specified by the operand (RBn) is made a register bank for use by the next and subsequent instructions.
- RBn ranges from RB0 to RB3.

[Description example]

SEL RB2; Register bank 2 is selected as the one for use by the next and subsequent instructions.

NOP

No Operation

No Operation

[Instruction format] **NOP****[Operation]** **no operation****[Operand]**

None

[Flag]

Z	AC	CY

[Description]

- Only the time is consumed without processing.

EI**Enable Interrupt
Interrupt Enabled****[Instruction format]** EI**[Operation]** $IE \leftarrow 1$ **[Operand]**

None

[Flag]

Z	AC	CY

[Description]

- The maskable interrupt acknowledgeable status is set (by setting the interrupt enable flag (IE) to (1)).
- No interrupts are acknowledged between this instruction and the next instruction.
- If this instruction is executed, vectored interrupt acknowledgment from another source can be disabled. For details, refer to “**Interrupt Functions**” in the user’s manual of each product.

DI**Disable Interrupt
Interrupt Disabled****[Instruction format]** **DI****[Operation]** **IE ← 0****[Operand]**

None

[Flag]

Z	AC	CY

[Description]

- Maskable interrupt acknowledgment by vectored interrupt is disabled (with the interrupt enable flag (IE) cleared (0)).
- No interrupts are acknowledged between this instruction and the next instruction.
- For details of interrupt servicing, refer to “**Interrupt Functions**” in the user’s manual of each product.

HALT**Halt**
HALT Mode Set**[Instruction format]** **HALT****[Operation]** **Set HALT Mode****[Operand]**
None**[Flag]**

Z	AC	CY

[Description]

- This instruction is used to set the HALT mode to stop the CPU operation clock. The total power consumption of the system can be decreased with intermittent operation by combining this mode with the normal operation mode.

STOP**Stop
Stop Mode Set****[Instruction format]** **STOP****[Operation]** **Set STOP Mode****[Operand]**

None

[Flag]

Z	AC	CY

[Description]

- This instruction is used to set the STOP mode to stop the main system clock oscillator and to stop the whole system. Power consumption can be minimized to only leakage current.

APPENDIX A REVISION HISTORY

The following table shows the revision history of the previous editions. The “Applied to:” column indicates the chapters of each edition in which the revision was applied.

Edition	Major Revision from Previous Edition	Applied to:
2nd	Addition of the following versions: μ PD78055 and 78P058, and μ PD78018F, 78044A, 78054Y, 78078, 78083, 78098, and 780208 Subseries	Throughout
	Addition of the English documentation No. to the related documents	INTRODUCTION
	Addition of the IEBus register area (μ PD78098 Subseries only)	CHAPTER 1 MEMORY SPACE
	Addition of the description of the number of clocks when the external ROM contains the program to the clock column.	CHAPTER 4 INSTRUCTION SET
	Addition of Notes to the description of the ROR4 and ROL4 instructions in the rotate instruction.	CHAPTER 5 EXPLANATION OF INSTRUCTIONS
	Change of the operation of the ADJBA and ADJBS instructions in the BCD adjust instruction.	
3rd	Addition of the following versions: μ PD78014H, 78018FY, 78044F, 78044H, 78058F, 78058FY, 78064Y, 78064B, 78075B, 78075BY, 78078Y, 78098B, 780018Y, 780024, 780024Y, 780034, 780034Y, 780058, 780058Y, 780228, 780308, 780308Y, 780924, and 780964 Subseries, and μ PD78011F, 78012F, 78070A, 78070AY, 780001, 78P0914, 780206, and 780208	Throughout
	Deletion of the following versions μ PD78024, 78044, and 78044A Subseries	
	Addition of the table of all internal RAM spaces of each model	CHAPTER 1 MEMORY SPACE
	Change of the format of external memory space table	
4th	Deletion of all information except for information common to the 78K/0 Series (for individual product information, refer to the user’s manual of each product).	Throughout

APPENDIX B INSTRUCTION INDEX (MNEMONIC: BY FUNCTION)

[8-bit data transfer instructions]

MOV ... 49
XCH ... 50

[16-bit data transfer instructions]

MOVW ... 52
XCHW ... 53

[8-bit operation instructions]

ADD ... 55
ADDC ... 56
SUB ... 57
SUBC ... 58
AND ... 59
OR ... 60
XOR ... 61
CMP ... 62

[16-bit operation instructions]

ADDW ... 64
SUBW ... 65
CMPW ... 66

[Multiply/divide instructions]

MULU ... 68
DIVUW ... 69

[Increment/decrement instructions]

INC ... 71
DEC ... 72
INCW ... 73
DECW ... 74

[Rotate instructions]

ROR ... 76
ROL ... 77
RORC ... 78
ROLC ... 79
ROR4 ... 80
ROL4 ... 81

[BCD adjust instructions]

ADJBA ... 83
ADJBS ... 84

[Bit manipulation instructions]

MOV1 ... 86
AND1 ... 87
OR1 ... 88
XOR1 ... 89
SET1 ... 90
CLR1 ... 91
NOT1 ... 92

[Call return instructions]

CALL ... 94
CALLF ... 95
CALLT ... 96
BRK ... 97
RET ... 98
RETI ... 99
RETB ... 100

[Stack manipulation instructions]

PUSH ... 102
POP ... 103
MOVW SP, src ... 104
MOVW AX, SP ... 104

[Unconditional branch instruction]

BR ... 106

[Conditional branch instructions]

BC ... 108

BNC ... 109

BZ ... 110

BNZ ... 111

BT ... 112

BF ... 113

BTCLR ...114

DBNZ ... 115

[CPU control instructions]

SEL RBn ... 117

NOP ... 118

EI ... 119

DI ... 120

HALT ... 121

STOP ... 122

APPENDIX C INSTRUCTION INDEX (MNEMONIC: IN ALPHABETICAL ORDER)

[A]

ADD ... 55
ADDC ... 56
ADDW ... 64
ADJBA ... 83
ADJBS ... 84
AND ... 59
AND1 ... 87

[B]

BC ... 108
BF ... 113
BNC ... 109
BNZ ... 111
BR ... 106
BRK ... 97
BT ... 112
BTCLR ... 114
BZ ... 110

[C]

CALL ... 94
CALLF ... 95
CALLT ... 96
CLR1 ... 91
CMP ... 62
CMPW ... 66

[D]

DBNZ ... 115
DEC ... 72
DECW ... 74
DI ... 120
DIVUW ... 69

[E]

EI ... 119

[H]

HALT ... 121

[I]

INC ... 71
INCW ... 73

[M]

MOV ... 49
MOVW ... 52
MOVW AX, SP ... 104
MOVW SP, src ... 104
MOV1 ... 86
MULU ... 68

[N]

NOP ... 118
NOT1 ... 92

[O]

OR ... 60
OR1 ... 88

[P]

POP ... 103
PUSH ... 102

[R]

RET ... 98
RETB ... 100
RETI ... 99
ROL ... 77
ROLC ... 79
ROL4 ... 81
ROR ... 76
RORC ... 78
ROR4 ... 80

[S]

SEL RBn ... 117

SET1 ... 90

STOP ... 122

SUB ... 57

SUBC ... 58

SUBW ... 65

[X]

XCH ... 50

XCHW ... 53

XOR ... 61

XOR1 ... 89

[MEMO]

Facsimile Message

Although NEC has taken all possible steps to ensure that the documentation supplied to our customers is complete, bug free and up-to-date, we readily accept that errors may occur. Despite all the care and precautions we've taken, you may encounter problems in the documentation. Please complete this form whenever you'd like to report errors or suggest improvements to us.

From:

Name

Company

Tel.

FAX

Address

Thank you for your kind support.

North America

NEC Electronics Inc.
Corporate Communications Dept.
Fax: +1-800-729-9288
+1-408-588-6130

Hong Kong, Philippines, Oceania

NEC Electronics Hong Kong Ltd.
Fax: +852-2886-9022/9044

Asian Nations except Philippines

NEC Electronics Singapore Pte. Ltd.
Fax: +65-250-3583

Europe

NEC Electronics (Europe) GmbH
Technical Documentation Dept.
Fax: +49-211-6503-274

Korea

NEC Electronics Hong Kong Ltd.
Seoul Branch
Fax: +82-2-528-4411

Japan

NEC Semiconductor Technical Hotline
Fax: +81-44-435-9608

South America

NEC do Brasil S.A.
Fax: +55-11-6462-6829

Taiwan

NEC Electronics Taiwan Ltd.
Fax: +886-2-2719-5951

I would like to report the following error/make the following suggestion:

Document title: _____

Document number: _____ Page number: _____

If possible, please fax the referenced page or drawing.

Document Rating	Excellent	Good	Acceptable	Poor
Clarity	<input type="checkbox"/>	<input type="checkbox"/>	<input type="checkbox"/>	<input type="checkbox"/>
Technical Accuracy	<input type="checkbox"/>	<input type="checkbox"/>	<input type="checkbox"/>	<input type="checkbox"/>
Organization	<input type="checkbox"/>	<input type="checkbox"/>	<input type="checkbox"/>	<input type="checkbox"/>