

### FEATURES

- InGaP HBT Technology
- Integrated Power Control (CMOS)
- Quad Band Applications
- +35 dBm GSM Output Power at 3.5 V
- +33 dBm DCS/PCS Output Power at 3.5 V
- 55% GSM PAE
- 50% DCS/PCS PAE
- Small Footprint: 7 x 10mm
- Low Profile: 1.4mm
- Power Control Range: >50 dB
- GPRS Capable (Class 12)
- Moisture Sensitivity Level (MSL) 3 at 260 °C

### APPLICATIONS

- GSM850/GSM900/DCS/PCS Handsets
- Dual/Tri/Quad Band PDA

### PRODUCT DESCRIPTION

This quad band power amplifier module is designed to support dual, tri and quad band applications. The module includes an integrated power control scheme that facilitates fast and easy production calibration and reduces the number of external components required to complete a power control function.

The amplifier's power control range is typically 55dB, with the output power set by applying an analog voltage to  $V_{RAMP}$ . The logical control inputs,

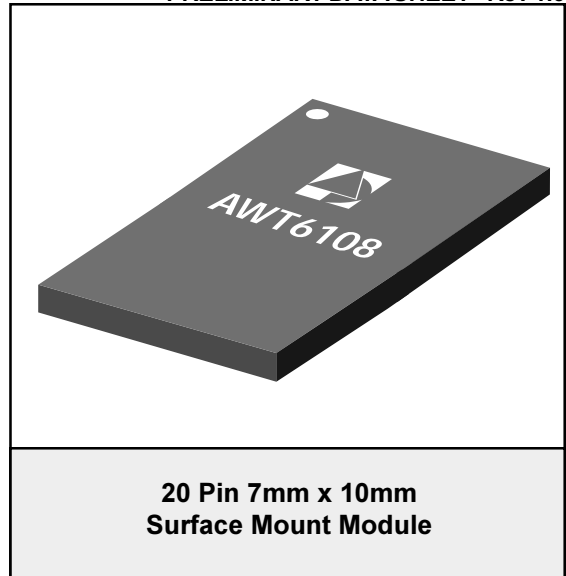

TX\_EN and BS, are both 1.8 V and 3 V logic compliant. The TX\_EN is used to enable the amplifier typically with the TX burst. The BS is used to select which amplifier is enabled.

There are two amplifier chains, one to support GSM850/900 bands, the other for DCS/PCS bands. All of the RF ports for this device are internally matched to 50 Ω. Internal DC blocks are provided at the RF ports.

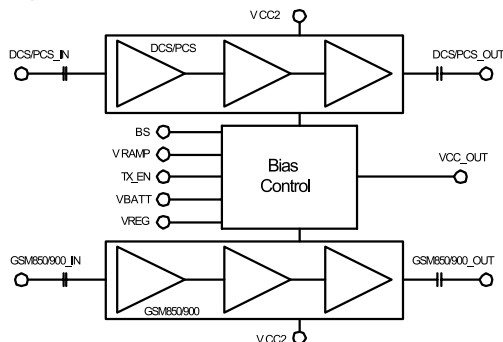

**Figure 1: Block Diagram**

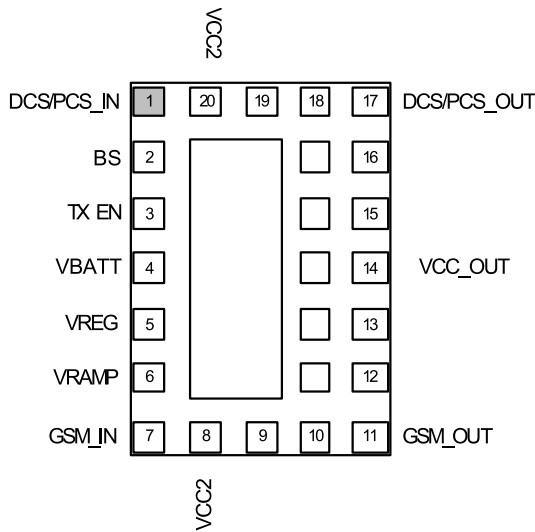

Figure 2: Pinout (X-Ray Top View)

Table 1: Pin Description

PIN	NAME	DESCRIPTION	PIN	NAME	DESCRIPTION
1	DCS/PCS_IN	DCS/PCS RF Input	11	GSM_OUT	GSM850/900 RF Output
2	BS	Band Select Logic Input	12	GND	Ground
3	TX_EN	TX Enable Logic Input	13	GND	Ground
4	VBATT	Battery Supply Connection	14	VCC_OUT	Control Voltage Output Which Must be Connected to VCC2, No Decoupling
5	VREG	Regulated Supply Connection	15	GND	Ground
6	VRAMP	Analog Signal Used to Control the Output Power	16	GND	Ground
7	GSM_IN	GSM850/900 RF Input	17	DCS/PCS_OUT	DCS/PCS RF Output
8	VCC2	VCC Control Input for GSM850/900 Pre-Amplifier	18	GND	Ground
9	GND	Ground	19	GND	Ground
10	GND	Ground	20	VCC2	VCC Control Input for DCS/PCS Pre-Amplifier

## ELECTRICAL CHARACTERISTICS

Table 2: Absolute Minimum and Maximum Ratings

PARAMETER	MIN	MAX	UNIT
Supply Voltage ( $V_{BATT}$ )	0	7	V
RF Input Power ( $RF_{IN}$ )	0	11	dBm
Control Voltage ( $V_{RAMP}$ )	-0.3	1.8	V
Storage Temperature ( $T_{STG}$ )	-55	150	°C

Stresses in excess of the absolute ratings may cause permanent damage. Functional operation is not implied under these conditions. Exposure to absolute ratings for extended periods of time may adversely affect reliability.

Table 3: ESD Ratings

PARAMETER	METHOD	RATING	UNIT
ESD Threshold Voltage (RF Ports)	HBM	>250	V
ESD Threshold Voltage (Control Inputs)	HBM	>2.5	kV

Although protection circuitry has been designed into this device, proper precautions should be taken to avoid exposure to electronic discharge (ESD) during handling and mounting. Human body model (HBM) employed is resistance = 1500  $\Omega$ , capacitance = 100 pF.

Table 4: Digital Inputs

PARAMETER	MIN	TYP	MAX	UNIT
Logic High Voltage ( $V_H$ )	1.2	-	$V_{REG}$	V
Logic Low Voltage ( $V_L$ )	-	-	0.5	V
Logic High Current ( $I_H$ )	-	-	30	$\mu A$
Logic Low Current ( $I_L$ )	-	-	30	$\mu A$

Table 5: Operating Ranges

PARAMETER	MIN	TYP	MAX	UNIT	COMMENTS
Case Temperature ( $T_c$ )	-20	-	85	$^{\circ}C$	
Supply Voltage ( $V_{BATT}$ )	3.0	3.5	5.5	V	
Regulated Voltage ( $V_{REG}$ )	2.7	2.8	2.9	V	
Regulated Current ( $I_{REG}$ )					
TX_EN = HIGH	-	6	8	mA	
TX_EN = LOW	-	10	30	$\mu A$	
Control Voltage for Maximum Power ( $V_{RAMP\_MAX}$ )	-	-	1.6	V	
Control Voltage for Minimum Power ( $V_{RAMP\_MIN}$ )	-	0.2	0.25	V	
Power Supply Leakage Current	-	1	10	$\mu A$	$V_{BATT} = 5.5 V$ , $V_{REG} = 0V$ , $V_{RAMP} = 0V$ , TX_EN = LOW, No RF Applied
$V_{RAMP}$ Input Capacitance	-	3	-	pF	
$V_{RAMP}$ Input Current	-	-	10	$\mu A$	$V_{RAMP} = V_{RAMP\_MAX}$
Turn On/Off Time	-	1	2	$\mu s$	$V_{RAMP} = 0.2V$ to $V_{RAMP\_MAX}$
Duty Cycle	-	-	50	%	

The device may be operated safely over these conditions; however, parametric performance is guaranteed only over the conditions defined in the electrical specifications.

**Table 6: Electrical Characteristics for GSM850/900**  
 ( $V_{BATT} = 3.5 \text{ V}$ ,  $V_{REG} = 2.8 \text{ V}$ ,  $P_{IN} = 2.0 \text{ dBm}$ , Pulse Width = 1154  $\mu\text{s}$ , Duty 25%,  
 $Z_{IN} = Z_{OUT} = 50\Omega$ ,  $T_C = 25 \text{ }^\circ\text{C}$ ,  $V_{RAMP} = 1.6 \text{ V}$ , BS = LOW, TX\_EN = HIGH)

PARAMETER	MIN	TYP	MAX	UNIT	COMMENTS
Operating Frequency ( $F_O$ )	824 880	- -	849 915	MHz	
Input Power	0	2	5	dBm	
Output Power ( $P_{MAX}$ )	34.5	35	-	dBm	Freq = 824 to 915 MHz
Degraded Output Power	32.0	32.5	-	dBm	$V_{BATT} = 3.0 \text{ V}$ , $T_C = 85 \text{ }^\circ\text{C}$ , $V_{REG} = 2.7 \text{ V}$ , $P_{IN} = 0 \text{ dBm}$
PAE @ $P_{MAX}$	48	55	-	%	Freq = 824 to 915 MHz
Forward Isolation 1	-	-37	-30	dBm	TX_EN = LOW, $P_{IN} = 5 \text{ dBm}$
Forward Isolation 2	-	-25	-10	dBm	TX_EN = HIGH, $V_{RAMP} = 0.2 \text{ V}$ , $P_{IN} = 5 \text{ dBm}$
Cross Isolation ( $2F_O$ @ DCS/PCS port)	-	-30	-20	dBm	$V_{RAMP} = 0.2 \text{ V}$ to $V_{RAMP\_MAX}$
Harmonics 2fo 3fo	- -	-17 -30	-5 -15	dBm	Over all output power levels
Stability	- -	- -	-36 -30	dBm	VSWR = 8:1 all phases, $P_{OUT} \leq 34.5 \text{ dBm}$ $F_{OUT} < 1\text{GHz}$ $F_{OUT} > 1\text{GHz}$
Ruggedness	-	-	10:1		All load phases, $P_{OUT} \leq 34.5 \text{ dBm}$
RX Noise Power	-	-86	-83	dBm	$F_{TX} = 849 \text{ MHz}$ , RBW = 100 kHz, $F_{RX} = 869 \text{ to } 894 \text{ MHz}$ , $P_{OUT} \leq 34.5 \text{ dBm}$
	-	-81	-77	dBm	$F_{TX} = 915 \text{ MHz}$ , RBW = 100 kHz, $F_{RX} = 925 \text{ to } 935 \text{ MHz}$ , $P_{OUT} \leq 34.5 \text{ dBm}$
	-	-86	-83	dBm	$F_{TX} = 915 \text{ MHz}$ , RBW = 100 kHz, $F_{RX} = 935 \text{ to } 960 \text{ MHz}$ , $P_{OUT} \leq 34.5 \text{ dBm}$
Input VSWR	-	-	2.5:1		Over all output power levels

**Table 7: Electrical Characteristics for DCS/PCS**  
 ( $V_{BATT} = 3.5 \text{ V}$ ,  $V_{REG} = 2.8 \text{ V}$ ,  $P_{IN} = 2.0 \text{ dBm}$ , Pulse Width = 1154  $\mu\text{s}$ , Duty 25%,  
 $Z_{IN} = Z_{OUT} = 50\Omega$ ,  $T_C = 25^\circ\text{C}$ ,  $V_{RAMP} = 1.6 \text{ V}$ , BS = HIGH, TX\_EN = HIGH)

PARAMETER	MIN	TYP	MAX	UNIT	COMMENTS
Operating Frequency ( $F_o$ )	1710 1850	- -	1785 1910	MHz	
Input Power	0	2	5	dBm	
Output Power ( $P_{MAX}$ )	32	33	-	dBm	
Degraded Output Power	29.5	30.5	-	dBm	$V_{BATT} = 3.0 \text{ V}$ , $T_C = 85^\circ\text{C}$ , $V_{REG} = 2.7 \text{ V}$ , $P_{IN} = 0 \text{ dBm}$
PAE @ $P_{MAX}$	45	50	-	%	Freq = 1710 to 1910 MHz
Forward Isolation 1	-	-37	-30	dBm	TX_EN = LOW, $P_{IN} = 5 \text{ dBm}$
Forward Isolation 2	-	-17	-10	dBm	TX_EN = HIGH, $V_{RAMP} = 0.2 \text{ V}$ , $P_{IN} = 5 \text{ dBm}$
Harmonics 2fo 3fo	- -	-12 -30	-5 -15	dBm	Over all output power levels
Stability	- -	- -	-36 -30	dBm	VSWR = 8:1 all phases, $P_{OUT} \leq 32 \text{ dBm}$ $F_{OUT} < 1\text{GHz}$ $F_{OUT} > 1\text{GHz}$
Ruggedness	-	-	10:1		All load phases, $P_{OUT} \leq 32 \text{ dBm}$
RX Noise Power	-	-87	-80	dBm	$F_{TX} = 1785 \text{ MHz}$ , $F_{RX} = 1805 \text{ to } 1880 \text{ MHz}$ , $P_{OUT} \leq 32.0 \text{ dBm}$
	-	-87	-80	dBm	$F_{TX} = 1910 \text{ MHz}$ , RBW = 100 kHz, $F_{RX} = 1930 \text{ to } 1990 \text{ MHz}$ , $P_{OUT} \leq 32.0 \text{ dBm}$
Input VSWR	-	-	2.5:1		Over all output power levels

PERFORMANCE DATA

Figure 3: GSM850/GSM900 Pout vs Vramp & Temperature  
(2 TX slots)

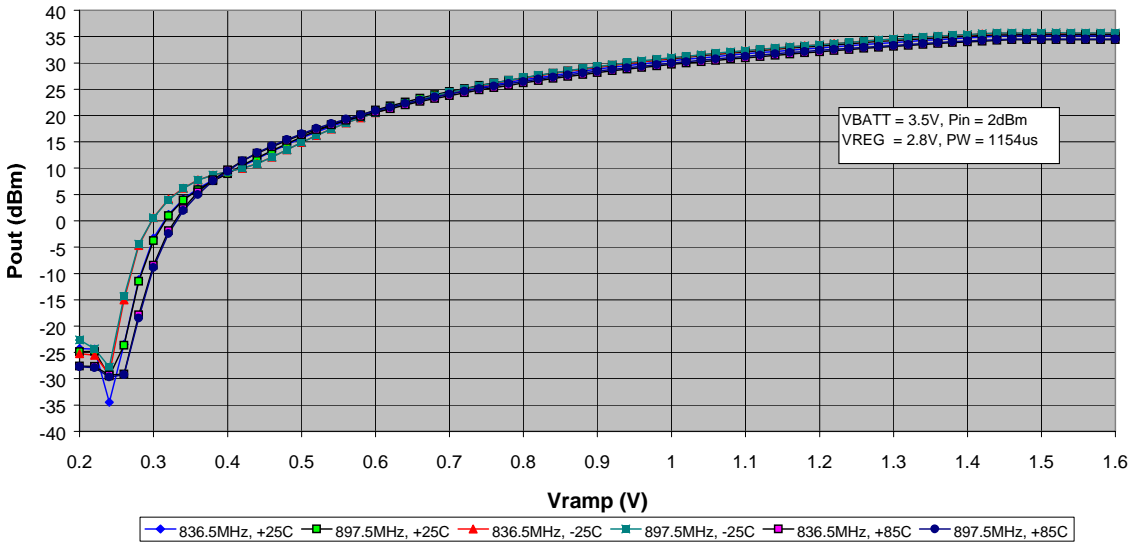

Figure 4: DCS/PCS Pout vs Vramp & Temperature  
(2 TX slots)

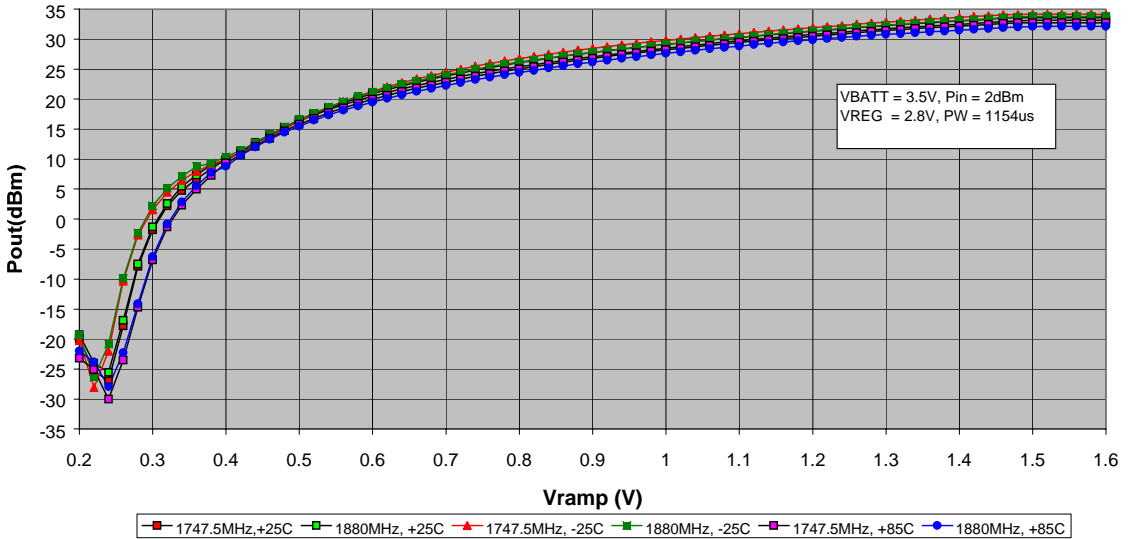

Figure 5: GSM850/GSM900 PMAX vs. Temperature @ Vramp=Vrampmax = 1.6V (2TX slots)

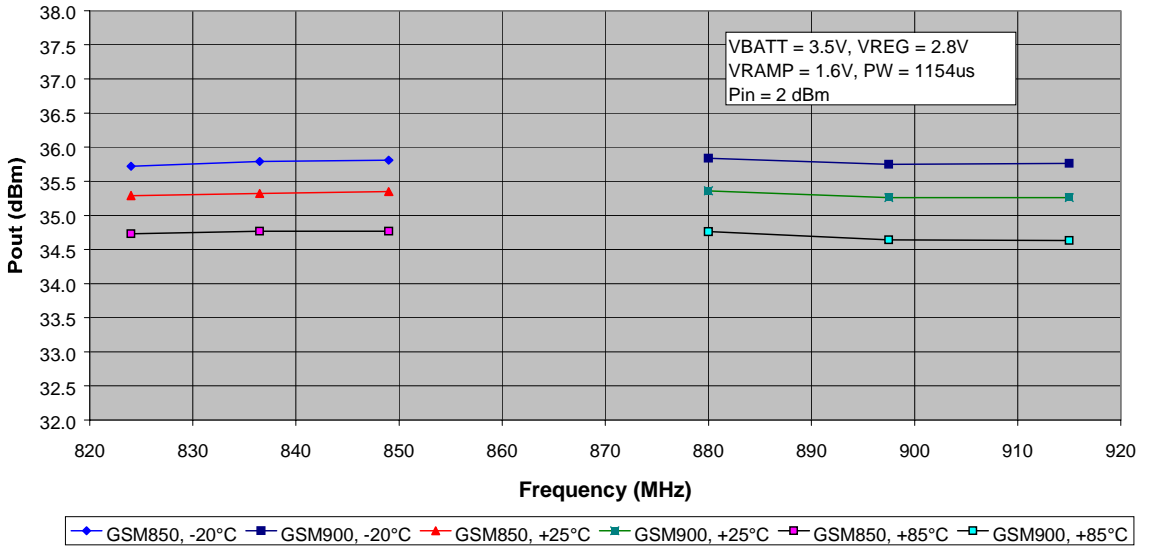
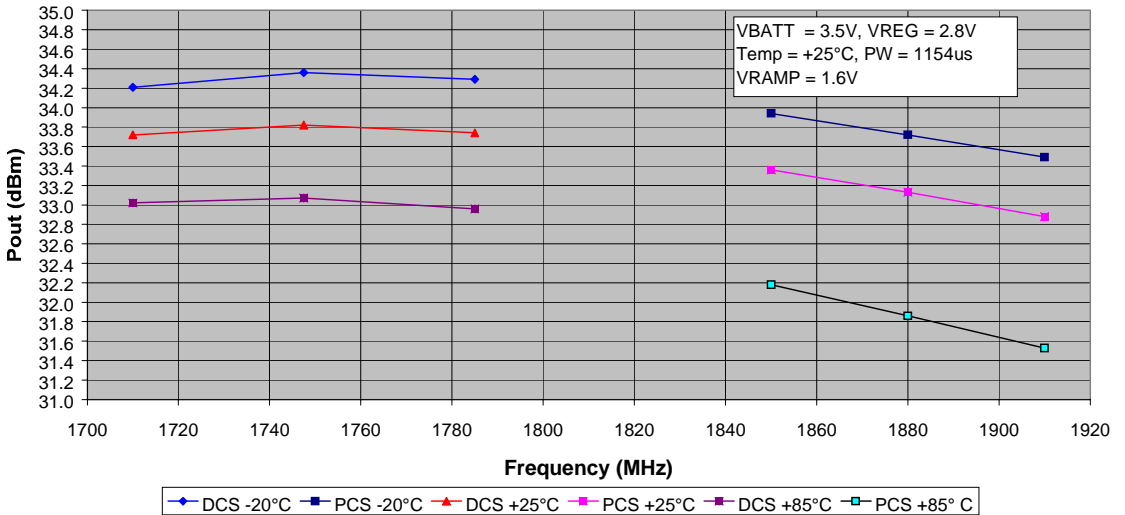
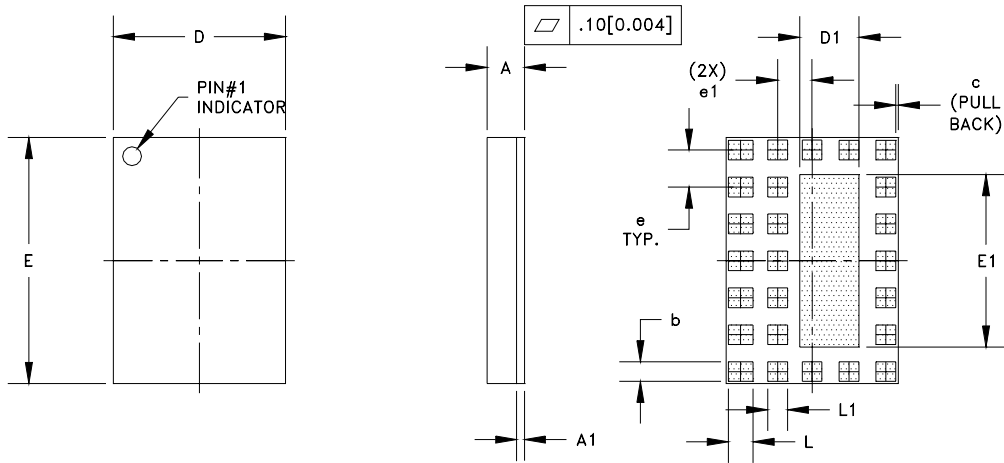

Figure 6: DCS/PCS PMAX vs. Temperature @ Vramp = Vrampmax = 1.6V (2TX slots)





PACKAGE OUTLINE



SYMBOL	MILLIMETERS			INCHES			NOTE
	MIN.	NOM.	MAX.	MIN.	NOM.	MAX.	
A	1.31	1.41	1.51	-	0.055	-	-
A1	-	0.31	-	-	0.012	-	-
b	-	0.80	-	-	0.031	-	25X
c	-	0.10	-	-	0.004	-	-
D	6.88	7.00	7.12	-	0.276	-	-
D1	-	2.40	-	-	0.094	-	-
E	9.88	10.00	10.12	-	0.394	-	-
E1	-	7.00	-	-	0.275	-	-
e	-	1.50	-	-	0.059	-	TYP.
e1	-	1.40	-	-	0.055	-	2X
L	-	1.00	-	-	0.039	-	7X
L1	-	0.80	-	-	0.031	-	18X

NOTES:

1. CONTROLLING DIMENSIONS: MILLIMETERS [INCHES].
2. UNLESS SPECIFIED TOLERANCE=±0.076[0.003].

Figure 7: Package Outline

TOP BRAND



NOTES:

1. ANADIGICS LOGO SIZE: X=0.080±0.010 Y=0.095±0.010
2. PART # AWT6108
3. YEAR AND WORK WEEK: YYWW: YY = YEAR, WW = WORK WEEK
4. LOT - WAFER I.D.: LLLLL = LOT#, SS = WAFER I.D.
5. PIN 1 INDICATOR: INK DOT
6. BOM # 2067-F
7. COUNTRY CODE: CCCCCC
8. TYPE : ELITE  
SIZE : AS LARGE AS POSSIBLE  
COLOR : WHITE or SILVER

Figure 8: Branding Specification

COMPONENT PACKAGING

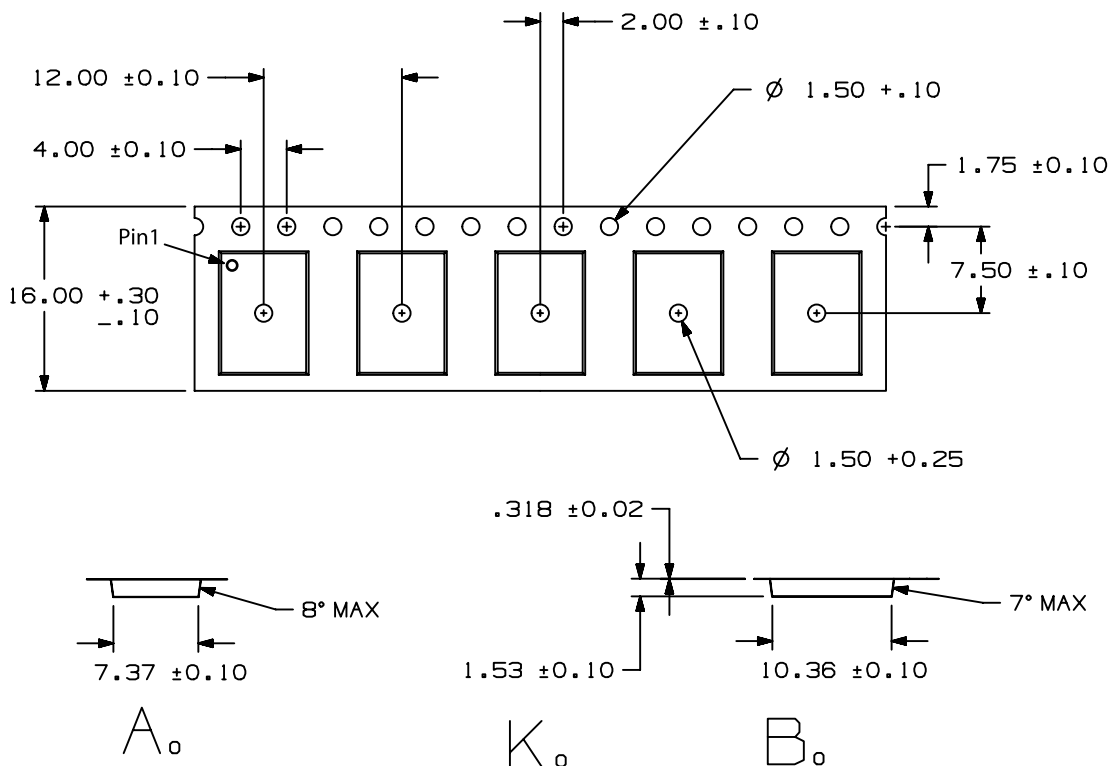

DIMENSIONS ARE IN MILLIMETERS

Figure 9: Tape & Reel Packaging

Table 8: Tape & Reel Dimensions

PACKAGE TYPE	TAPE WIDTH	POCKET PITCH	REEL CAPACITY	MAX REEL DIA
7mm X 10mm	16mm	12mm	2500	22"

NOTES

**ORDERING INFORMATION**

ORDER NUMBER	TEMPERATURE RANGE	PACKAGE DESCRIPTION	COMPONENT PACKAGING
AWT6108M10P8	-30 °C to +110 °C	20 Pin 7mm x 10mm Surface Mount Module	Tape and Reel, 2500 pieces per reel

**ANADIGICS, Inc.**

141 Mount Bethel Road  
Warren, New Jersey 07059, U.S.A.

Tel: +1 (908) 668-5000

Fax: +1 (908) 668-5132

URL: <http://www.anadigics.com>

E-mail: [Mktg@anadigics.com](mailto:Mktg@anadigics.com)

**IMPORTANT NOTICE**

ANADIGICS, Inc. reserves the right to make changes to its products or to discontinue any product at any time without notice. The product specifications contained in Advanced Product Information sheets and Preliminary Data Sheets are subject to change prior to a product's formal introduction. Information in Data Sheets have been carefully checked and are assumed to be reliable; however, ANADIGICS assumes no responsibilities for inaccuracies. ANADIGICS strongly urges customers to verify that the information they are using is current before placing orders.

**WARNING**

ANADIGICS products are not intended for use in life support appliances, devices or systems. Use of an ANADIGICS product in any such application without written consent is prohibited.