

High-Current Complementary Silicon Power Transistors

... designed for use in high-power amplifier and switching circuit applications,

- High Current Capability — I_C Continuous = 60 Amperes
- DC Current Gain — $h_{FE} = 15-100$ @ $I_C = 50$ Adc
- Low Collector-Emitter Saturation Voltage —
 $V_{CE(sat)} = 2.5$ Vdc (Max) @ $I_C = 50$ Adc

MAXIMUM RATINGS

Rating	Symbol	MJ14001	MJ14002 MJ14003	Unit
Collector-Emitter Voltage	V_{CEO}	60	80	Vdc
Collector Base Voltage	V_{CBO}	60	80	Vdc
Emitter-Base Voltage	V_{EBO}	5		Vdc
Collector Current — Continuous	I_C	60		Adc
Base Current — Continuous	I_B	15		Adc
Emitter Current — Continuous	I_E	75		
Total Power Dissipation @ $T_C = 25^\circ\text{C}$ Derate above 25°C	P_D	300	17	Watts W/ $^\circ\text{C}$
Operating and Storage Junction Temperature Range	T_J, T_{stg}	-65 to +200		$^\circ\text{C}$

THERMAL CHARACTERISTICS

Characteristic	Symbol	Max	Unit
Thermal Resistance, Junction to Case	$R_{\theta JC}$	0.584	$^\circ\text{C}/\text{W}$

NPN
MJ14002*
PNP
MJ14001
MJ14003*

*Motorola Preferred Device

60 AMPERES
COMPLEMENTARY
SILICON
POWER TRANSISTORS
60-80 VOLTS
300 WATTS

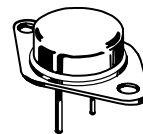

CASE 197A-05
TO-204AE (TO-3)

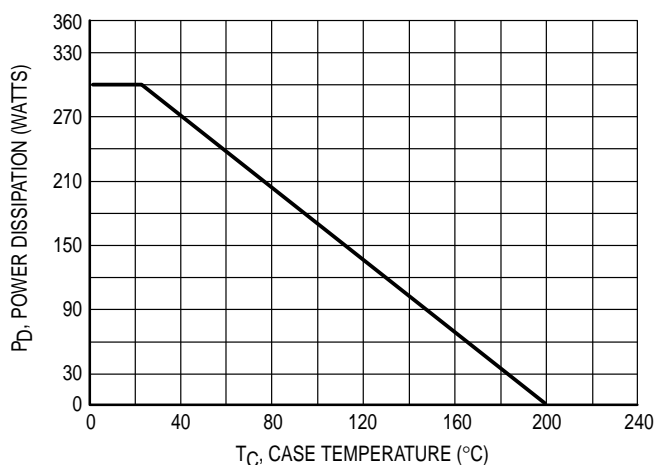

Figure 1. Power Derating

Preferred devices are Motorola recommended choices for future use and best overall value.

MJ14002 MJ14001 MJ14003

ELECTRICAL CHARACTERISTICS ($T_C = 25^\circ\text{C}$ unless otherwise noted)

Characteristic	Symbol	Min	Max	Unit
OFF CHARACTERISTICS				
Collector–Emitter Sustaining Voltage (1) ($I_C = 200\text{ mAdc}$, $I_B = 0$)	$V_{CEO(sus)}$	60 80	—	Vdc
Collector Cutoff Current ($V_{CE} = 30\text{ Vdc}$, $I_B = 0$) ($V_{CE} = 40\text{ Vdc}$, $I_B = 0$)	I_{CEO}	— —	1.0 1.0	mA
Collector Cutoff Current ($V_{CE} = 60\text{ Vdc}$, $V_{BE(off)} = 1.5\text{ V}$) ($V_{CE} = 80\text{ Vdc}$, $V_{BE(off)} = 1.5\text{ V}$)	I_{CEX}	— —	1.0 1.0	mA
Collector Cutoff Current ($V_{CB} = 60\text{ Vdc}$, $I_E = 0$) ($V_{CB} = 80\text{ Vdc}$, $I_E = 0$)	I_{CBO}	— —	1.0 1.0	mA
Emitter Cutoff Current ($V_{BE} = 5\text{ Vdc}$, $I_C = 0$)	I_{EBO}	—	1.0	mA

ON CHARACTERISTICS

DC Current Gain (1) ($I_C = 25\text{ Adc}$, $V_{CE} = 3.0\text{ V}$) ($I_C = 50\text{ Adc}$, $V_{CE} = 3.0\text{ V}$) ($I_C = 60\text{ Adc}$, $V_{CE} = 3.0\text{ V}$)	h_{FE}	30 15 5	— 100 —	—
Collector–Emitter Saturation Voltage (1) ($I_C = 25\text{ Adc}$, $I_B = 2.5\text{ Adc}$) ($I_C = 50\text{ Adc}$, $I_B = 5.0\text{ Adc}$) ($I_C = 60\text{ Adc}$, $I_B = 12\text{ Adc}$)	$V_{CE(sat)}$	— — —	1 2.5 3	Vdc
Base–Emitter Saturation Voltage (1) ($I_C = 25\text{ Adc}$, $I_B = 2.5\text{ Adc}$) ($I_C = 50\text{ Adc}$, $I_B = 5.0\text{ Adc}$) ($I_C = 60\text{ Adc}$, $I_B = 12\text{ Adc}$)	$V_{BE(sat)}$	— — —	2 3 4	Vdc

DYNAMIC CHARACTERISTICS

Output Capacitance ($V_{CB} = 10\text{ Vdc}$, $I_E = 0$, $f = 0.1\text{ MHz}$)	C_{ob}	—	2000	pF
---	----------	---	------	----

(1) Pulse Test: Pulse Width = 300 μs , Duty Cycle $\leq 2\%$.

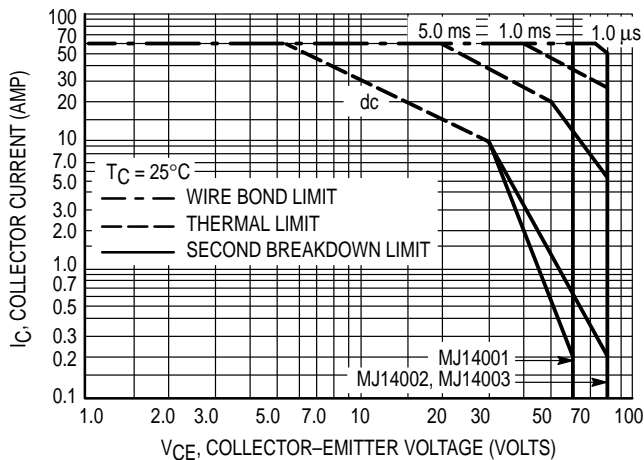
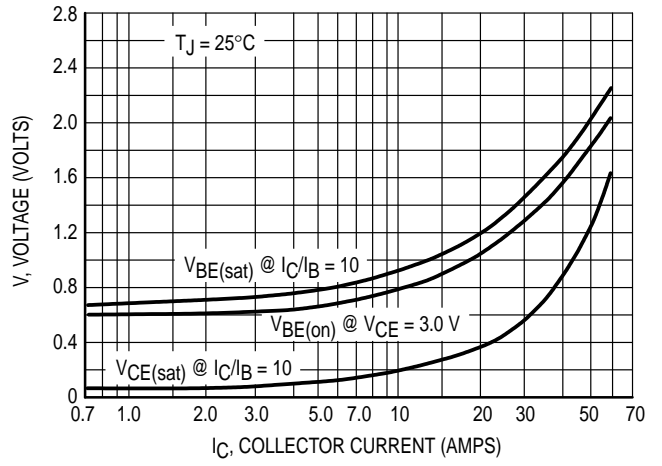
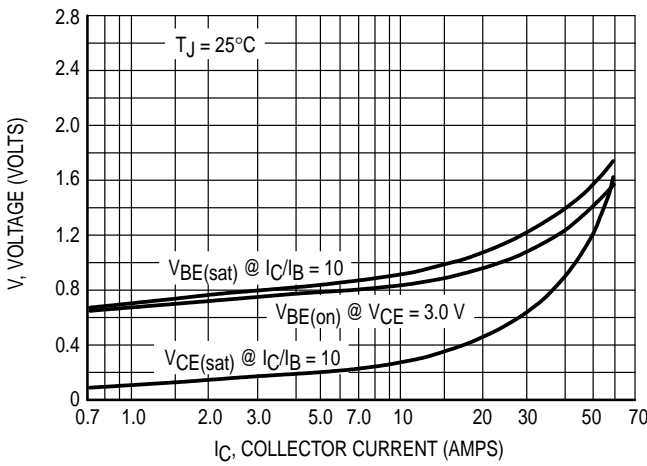
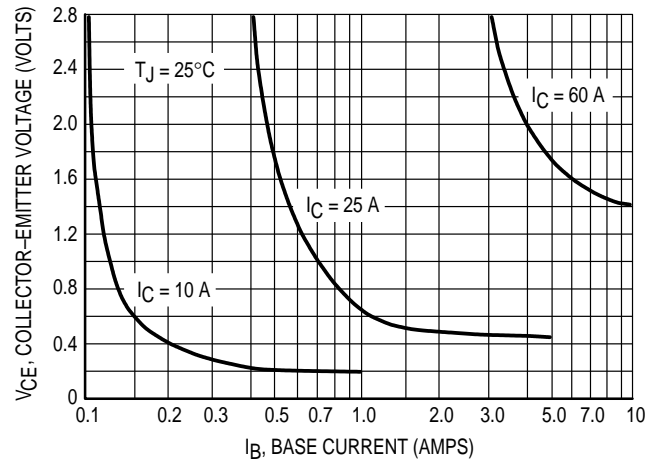
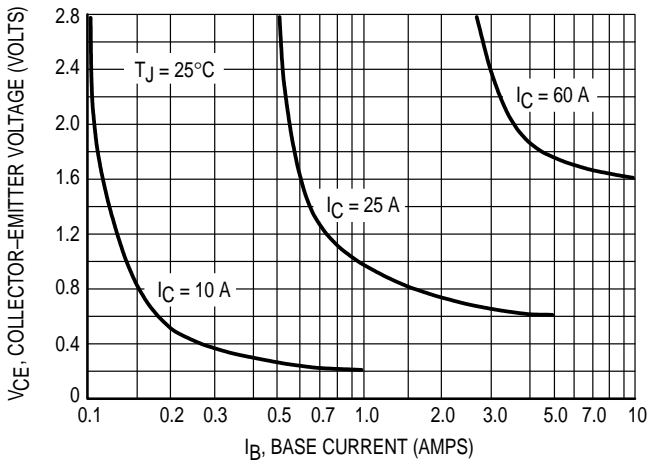
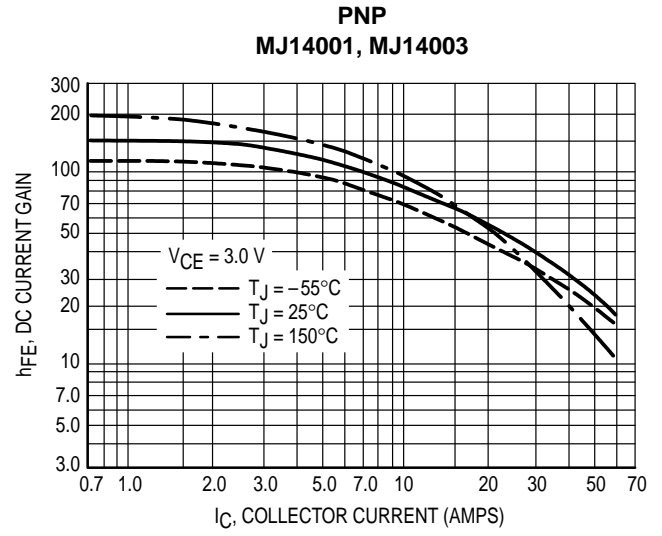
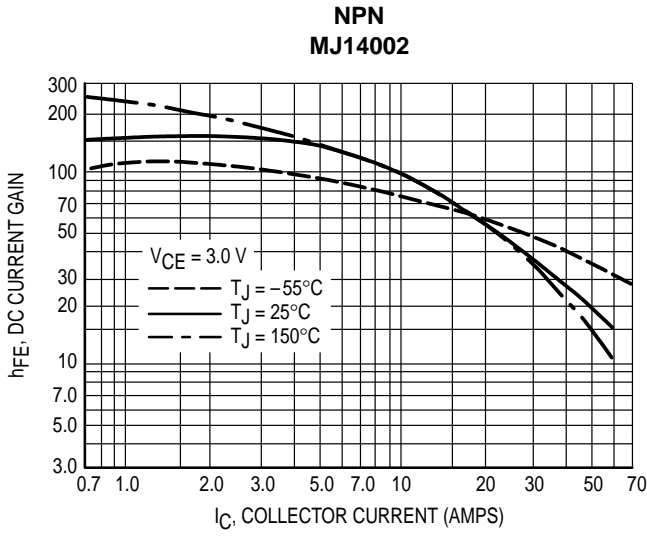

Figure 2. Maximum Rated Forward Biased Safe Operating Area

There are two limitations on the power handling ability of a transistor: average junction temperature and second breakdown. Safe operating area curves indicate $I_C - V_{CE}$ limits of the transistor that must be observed for reliable operation: i.e., the transistor must not be subjected to greater dissipation than the curves indicate.

The data of Figure 2 is based on $T_{J(pk)} = 200^\circ\text{C}$; T_C is variable depending on conditions. Second breakdown pulse limits are valid for duty cycles to 10% provided $T_{J(pk)} \leq 200^\circ\text{C}$. $T_{J(pk)}$ may be calculated from the data in Figure 13. At high case temperatures, thermal limitations will reduce the power that can be handled to values less than the limitations imposed by second breakdown.

TYPICAL ELECTRICAL CHARACTERISTICS



MJ14002 MJ14001 MJ14003

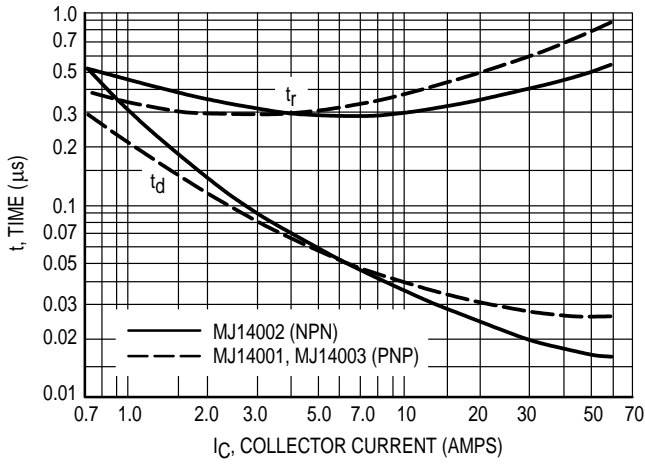

Figure 9. Turn-On Switching Times

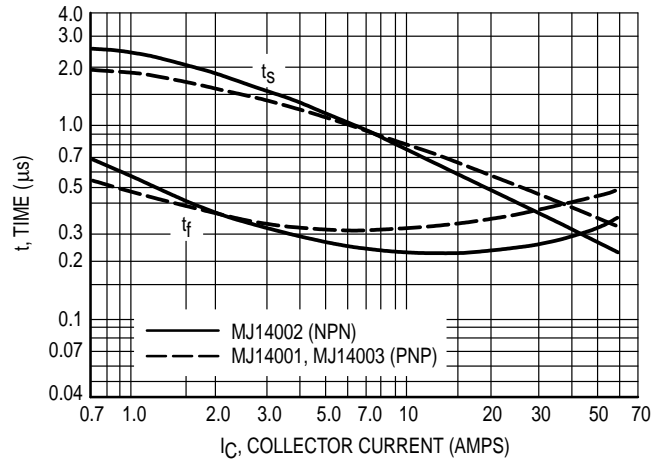

Figure 10. Turn-Off Switching Times

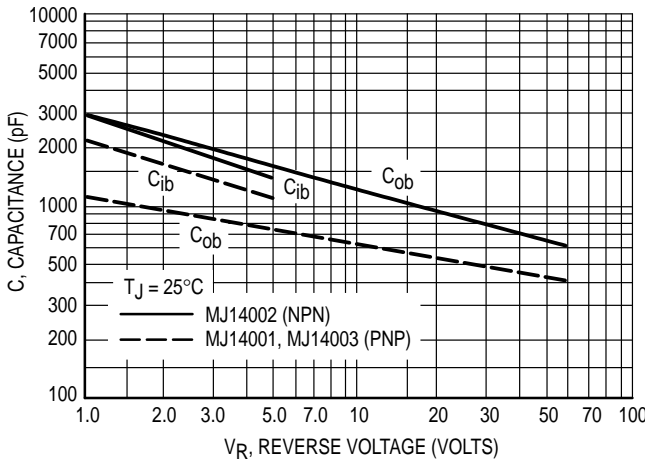
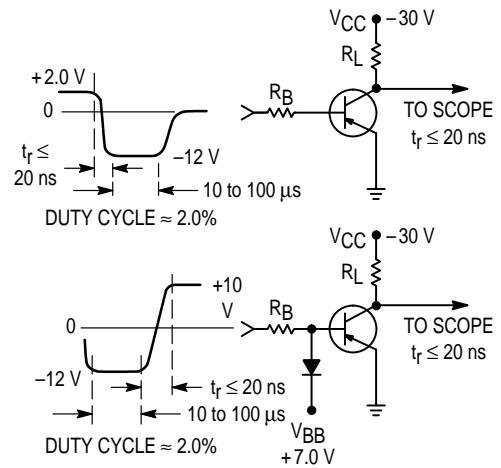

Figure 11. Capacitance Variation



FOR CURVES OF FIGURES 3 & 6, R_B & R_L ARE VARIED. INPUT LEVELS ARE APPROXIMATELY AS SHOWN. FOR NPN CIRCUITS, REVERSE ALL POLARITIES.

Figure 12. Switching Test Circuit

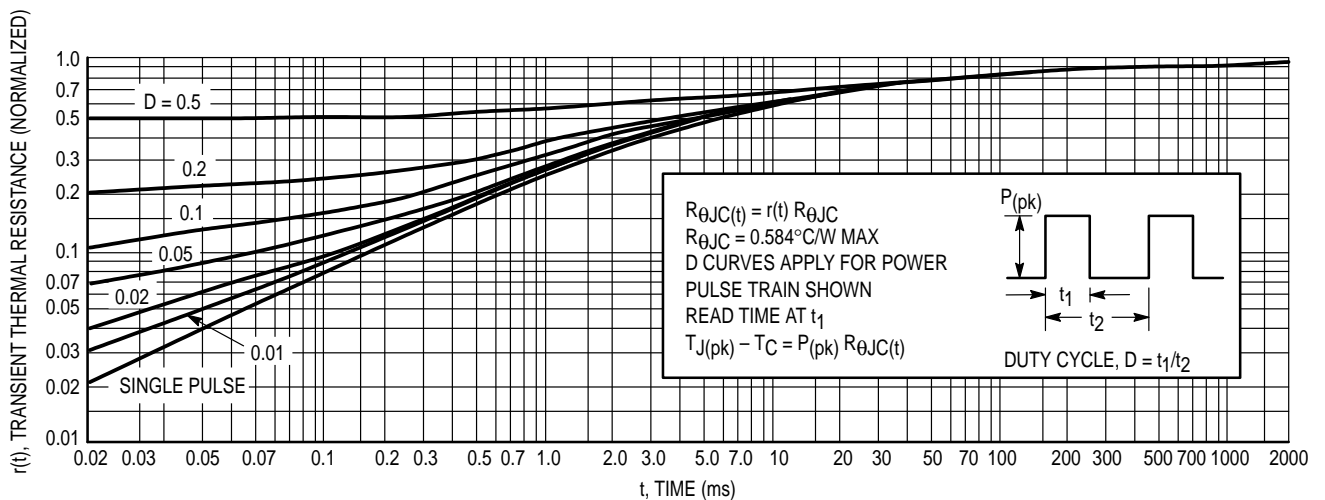
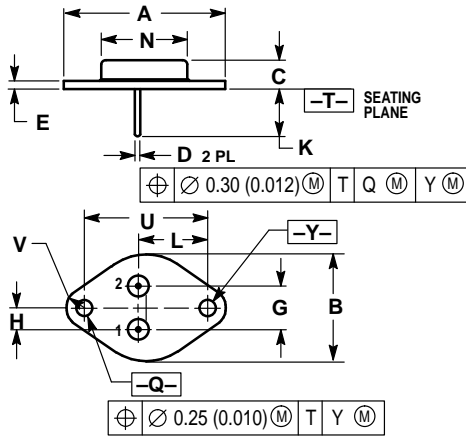

Figure 13. Thermal Response

PACKAGE DIMENSIONS



- NOTES:
 1. DIMENSIONING AND TOLERANCING PER ANSI Y14.5M, 1982.
 2. CONTROLLING DIMENSION: INCH.

DIM	INCHES		MILLIMETERS	
	MIN	MAX	MIN	MAX
A	1.530 REF		38.86 REF	
B	0.990	1.050	25.15	26.67
C	0.250	0.335	6.35	8.51
D	0.057	0.063	1.45	1.60
E	0.060	0.070	1.53	1.77
G	0.430 BSC		10.92 BSC	
H	0.215 BSC		5.46 BSC	
K	0.440	0.480	11.18	12.19
L	0.665 BSC		16.89 BSC	
N	0.760	0.830	19.31	21.08
Q	0.151	0.165	3.84	4.19
U	1.187 BSC		30.15 BSC	
V	0.131	0.188	3.33	4.77

STYLE 1:
 PIN 1: BASE
 2: EMITTER
 CASE: COLLECTOR

**CASE 197A-05
 TO-204AE (TO-3)
 ISSUE J**

Motorola reserves the right to make changes without further notice to any products herein. Motorola makes no warranty, representation or guarantee regarding the suitability of its products for any particular purpose, nor does Motorola assume any liability arising out of the application or use of any product or circuit, and specifically disclaims any and all liability, including without limitation consequential or incidental damages. "Typical" parameters can and do vary in different applications. All operating parameters, including "Typicals" must be validated for each customer application by customer's technical experts. Motorola does not convey any license under its patent rights nor the rights of others. Motorola products are not designed, intended, or authorized for use as components in systems intended for surgical implant into the body, or other applications intended to support or sustain life, or for any other application in which the failure of the Motorola product could create a situation where personal injury or death may occur. Should Buyer purchase or use Motorola products for any such unintended or unauthorized application, Buyer shall indemnify and hold Motorola and its officers, employees, subsidiaries, affiliates, and distributors harmless against all claims, costs, damages, and expenses, and reasonable attorney fees arising out of, directly or indirectly, any claim of personal injury or death associated with such unintended or unauthorized use, even if such claim alleges that Motorola was negligent regarding the design or manufacture of the part. Motorola and  are registered trademarks of Motorola, Inc. Motorola, Inc. is an Equal Opportunity/Affirmative Action Employer.

How to reach us:

USA / EUROPE: Motorola Literature Distribution;
P.O. Box 20912; Phoenix, Arizona 85036. 1-800-441-2447

JAPAN: Nippon Motorola Ltd.; Tatsumi-SPD-JLDC, Toshikatsu Otsuki,
6F Seibu-Butsuryu-Center, 3-14-2 Tatsumi Koto-Ku, Tokyo 135, Japan. 03-3521-8315

MFAX: RMFAX0@email.sps.mot.com – TOUCHTONE (602) 244-6609
INTERNET: <http://Design-NET.com>

HONG KONG: Motorola Semiconductors H.K. Ltd.; 8B Tai Ping Industrial Park,
51 Ting Kok Road, Tai Po, N.T., Hong Kong. 852-26629298

