

## Features

- High-performance, High-density, Electrically-erasable Programmable Logic Device
- Fully Connected Logic Array with 416 Product Terms
- 10 ns Maximum Pin-to-pin Delay for 5V Operation
- Low-power Edge-sensing "L" Option with <1 mA Standby Current
- 24 Flexible Output Macrocells
  - 48 Flip-flops – Two per Macrocell
  - 72 Sum Terms
  - All Flip-flops, I/O Pins Feed in Independently
- D- or T-type Flip-flops
- Product Term or Direct Input Pin Clocking
- Registered or Combinatorial Internal Feedback
- Backward Compatible with ATV2500B/BQL and ATV2500H/L Software
- Advanced Electrically-erasable Technology
  - Reprogrammable
  - 100% Tested
- 44-lead Surface Mount Package

## Block Diagram

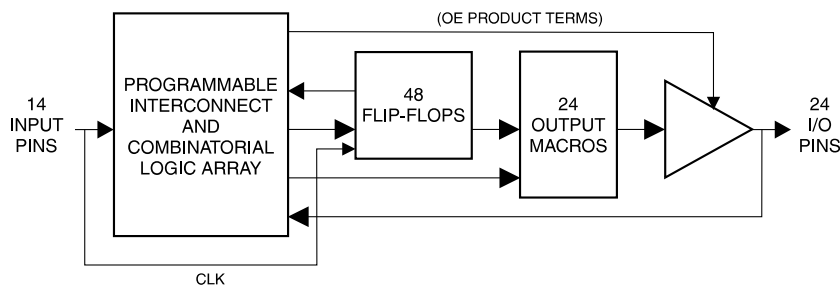

## Description

The ATF2500C is the highest-density PLD available in a 44-pin package. With its fully connected logic array and flexible macrocell structure, high gate utilization is easily obtainable. The ATF2500C is a high-performance CMOS (electrically-erasable) programmable logic device (PLD) that utilizes Atmel's proven electrically-erasable technology.

## Pin Configurations

Pin Name	Function
IN	Logic Inputs
CLK/IN	Pin Clock and Input
I/O	Bi-directional Buffers
I/O 0,2,4...	"Even" I/O Buffers
I/O 1,3,5...	"Odd" I/O Buffers
GND	Ground
VCC	+5V Supply

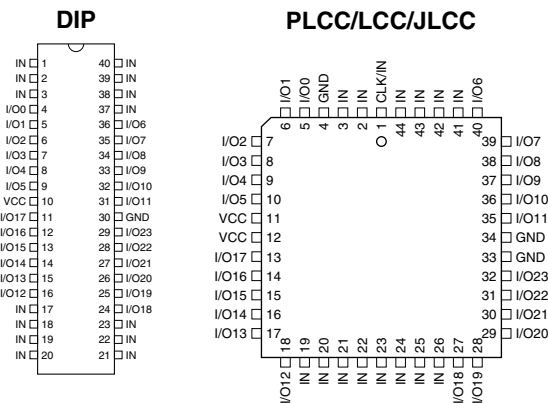

Note: For ATF2500CQ and ATF2500CQL (PLCC/LCC/JLCC packages) pin 4 and pin 26 GND connections are not required.



## ATF2500C CPLD Family Datasheet

ATF2500C  
ATF2500CL  
ATF2500CQ  
ATF2500CQL

Preliminary





The ATF2500C is organized around a single universal array. All pins and feedback terms are always available to every macrocell. Each of the 38 logic pins are array inputs, as are the outputs of each flip-flop.

In the ATF2500C, four product terms are input to each sum term. Furthermore, each macrocell's three sum terms can be combined to provide up to 12 product terms per sum term with no performance penalty. Each flip-flop is individually selectable to be either D- or T-type, providing further logic compaction. Also, 24 of the flip-flops may be bypassed to provide internal combinatorial feedback to the logic array.

Product terms provide individual clocks and asynchronous resets for each flip-flop. The flip-flops may also be individually configured to have direct input pin clocking. Each output has its own enable product term. Eight synchronous preset product terms serve local groups of either four or eight flip-flops. Register preload functions are provided to simplify testing. All registers automatically reset upon power-up.

The Atmel-unique "L" low-power feature is an edge-sensing option that is now field programmable for the ATF2500C family. The "L" feature utilizes Atmel-patented Input Transition Detection (ITD) circuitry and is activated by selecting the "L" option from the program menu.

## Using the ATF2500C Family's Many Advanced Features

The ATF2500Cs advanced flexibility packs more usable gates into 44 leads than other PLDs. Some of the ATF2500Cs key features are:

- **Fully Connected Logic Array** – Each array input is always available to every product term. This makes logic placement a breeze.
- **Selectable D- and T-Type Registers** – Each ATF2500C flip-flop can be individually configured as either D- or T-type. Using the T-type configuration, JK and SR flip-flops are also easily created. These options allow more efficient product term usage.
- **Buried Combinatorial Feedback** – Each macrocell's Q2 register may be bypassed to feed its input (D/T2) directly back to the logic array. This provides further logic expansion capability without using precious pin resources.
- **Selectable Synchronous/Asynchronous Clocking** – Each of the ATF2500Cs flip-flops has a dedicated clock product term. This removes the constraint that all registers use the same clock. Buried state machines, counters and registers can all coexist in one device while running on separate clocks. Individual flip-flop clock source selection further allows mixing higher performance pin clocking and flexible product term clocking within one design.
- **A Total of 48 Registers** – The ATF2500C provides two flip-flops per macrocell – a total of 48. Each register has its own clock and reset terms, as well as its own sum term.
- **Independent I/O Pin and Feedback Paths** – Each I/O pin on the ATF2500C has a dedicated input path. Each of the 48 registers has its own feedback term into the array as well. These features, combined with individual product terms for each I/O's output enable, facilitate true bi-directional I/O design.
- **Combinable Sum Terms** – Each output macrocell's three sum terms may be combined into a single term. This provides a fan in of up to 12 product terms per sum term with *no speed penalty*.





## Preload and Observability of Registered Outputs

The ATF2500Cs registers are provided with circuitry to allow loading of each register asynchronously with either a high or a low. This feature will simplify testing since any state can be forced into the registers to control test sequencing. A  $V_{IH}$  level on the odd I/O pins will force the appropriate register high; a  $V_{IL}$  will force it low, independent of the polarity or other configuration bit settings.

The PRELOAD state is entered by placing an 10.25V to 10.75V signal on SMP lead 42. When the preload clock SMP lead 23 is pulsed high, the data on the I/O pins is placed into the 12 registers chosen by the Q select and even/odd select pins.

Register 2 observability mode is entered by placing an 10.25V to 10.75V signal on pin/lead 2. In this mode, the contents of the buried register bank will appear on the associated outputs when the OE control signals are active.

## Programming Software Support

All family members of the ATF2500C can be designed with Atmel-Synario™ and Atmel-WinCUPL™. ProChip™ designer support will be available Q102.

Additionally, the ATF2500C may be programmed to perform the ATV2500H/Ls functional subset (no T-type flip-flops, pin clocking or D/T2 feedback) using the ATV2500H/L JEDEC file. In this case, the ATF2500C becomes a direct replacement or speed upgrade for the ATV2500H/L. The ATF2500CQ/CQL are direct replacements for the ATV2500BQ/BQL and the AT2500H/L, including the lack of extra grounds on P4 and P26.

## Security Fuse Usage

A single fuse is provided to prevent unauthorized copying of ATF2500C fuse patterns. Once programmed, the outputs will read programmed during verify.

The security fuse should be programmed last, as its effect is immediate.

The security fuse also inhibits Preload and Q2 observability.

## Input and I/O Pull-ups

All ATF2500C family members have programmable internal input and I/O pinkeeper circuits.

The default condition, including when using the AT2500CQ/CQL family to replace the AT2500BQ/BQL or AT2500H/L, is that the pinkeepers are not activated.

When pinkeepers are active, inputs or I/Os not being driven externally will maintain their last driven state. This ensures that all logic array inputs and device outputs are known states. Pinkeepers are relatively weak active circuits that can be easily overridden by TTL-compatible drivers (see input and I/O diagrams below).

## Input Diagram

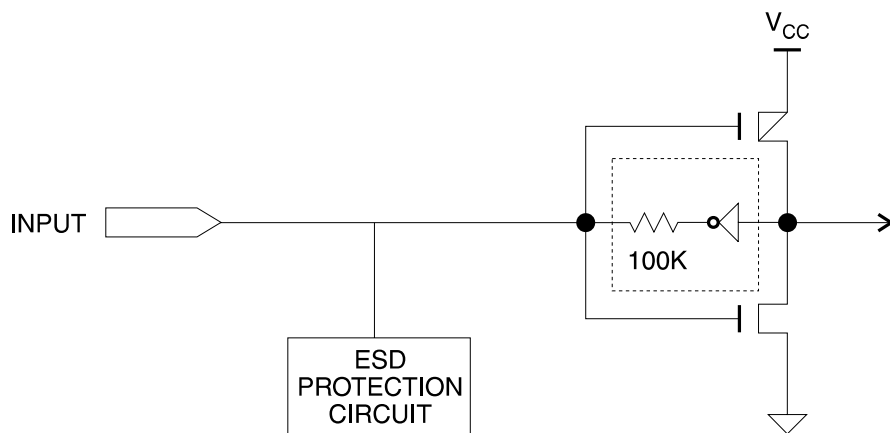

## I/O Diagram

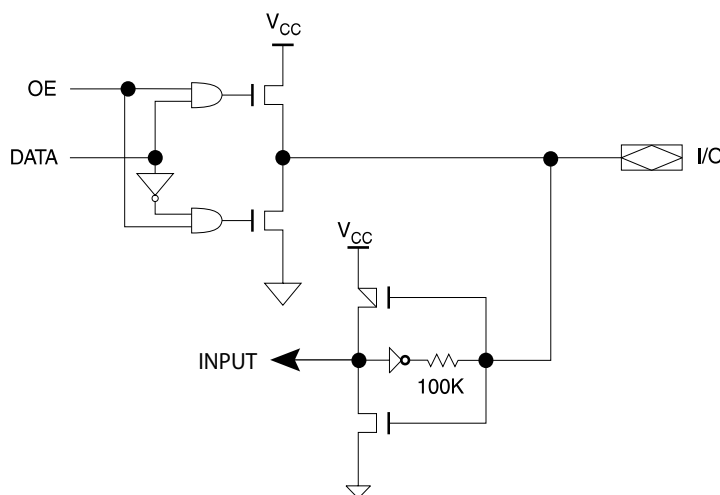

## Functional Logic Diagram Description

The ATF2500C functional logic diagram describes the interconnections between the input, feedback pins and logic cells. All interconnections are routed through the single global bus.

The ATF2500Cs are straightforward and uniform PLDs. The 24 macrocells are numbered 0 through 23. Each macrocell contains 17 AND gates. All AND gates have 172 inputs. The five lower product terms provide AR1, CK1, CK2, AR2, and OE. These are: one asynchronous reset and clock per flip-flop, and an output enable. The top 12 product terms are grouped into three sum terms, which are used as shown in the macrocell diagrams.

Eight synchronous preset terms are distributed in a 2/4 pattern. The first four macrocells share Preset 0, the next two share Preset 1, and so on, ending with the last two macrocells sharing Preset 7.

The 14 dedicated inputs and their complements use the numbered positions in the global bus as shown. Each macrocell provides six inputs to the global bus: (left to right) feedback  $F2^{(1)}$  true and false, flip-flop Q1 true and false, and the pin true and false. The positions occupied by these signals in the global bus are the six numbers in the bus diagram next to each macrocell.

Note: 1. Either the flip-flop input (D/T2) or output (Q2) may be fed back in the ATF2500Cs.



# Functional Logic Diagram ATF2500C

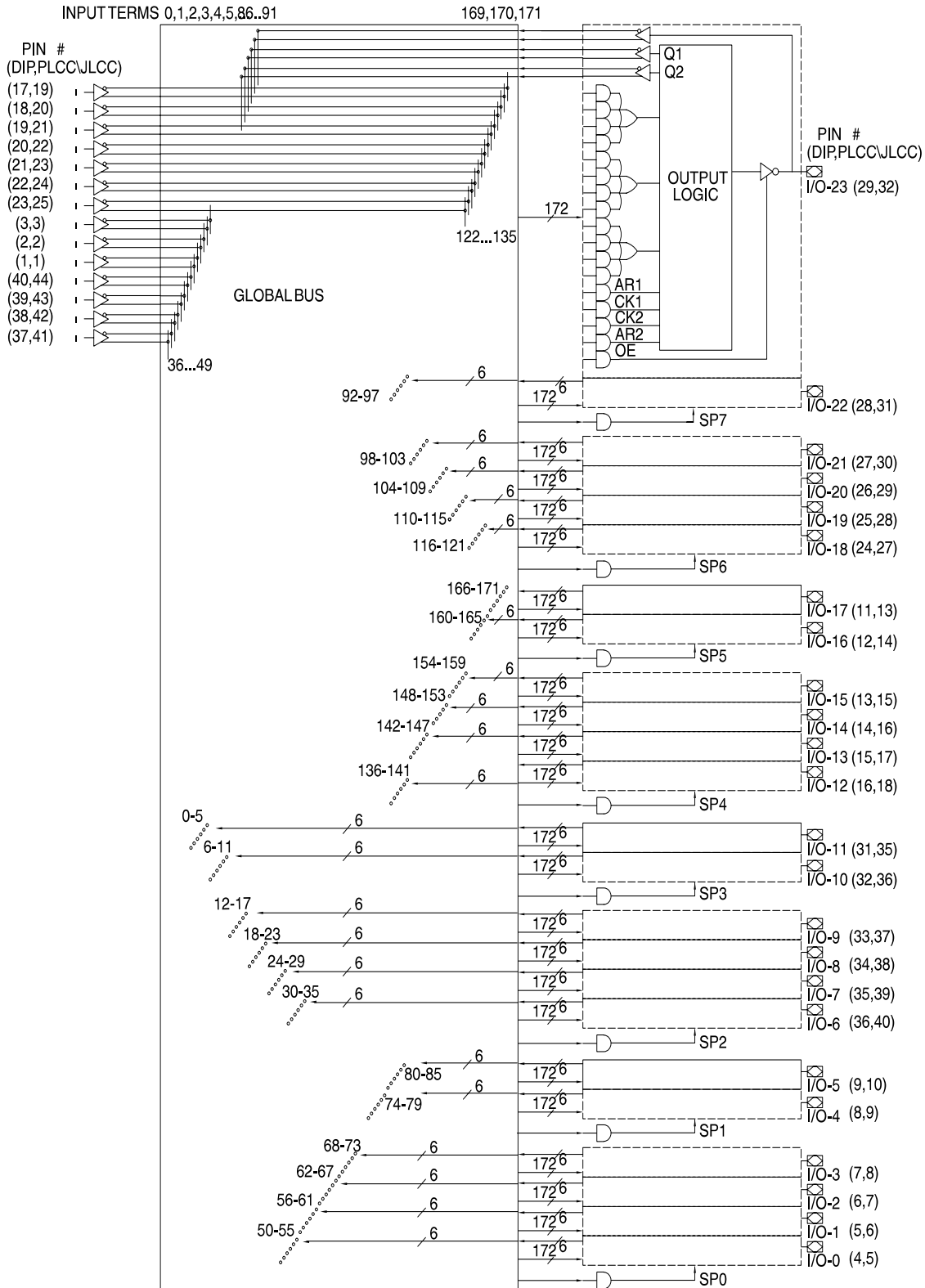

- Notes:
1. Pin 4 and Pin 26 are "ground" connections and are not required for PLCC, LCC and JLCC versions of ATF2500CQ or ATF2500CQL, making them compatible with ATF2500H and ATF2500L as well as ATF2500BQ and ATF2500BQL pinouts.
  2. For DIP package, VCC = P10 and GND = P30. For, PLCC, LCC and JLCC packages, VCC = P11 and P12, GND1 = P33 and P34, and GND2 = P4, P26 (See Note 1, above).

## Output Logic, Registered<sup>(1)</sup>

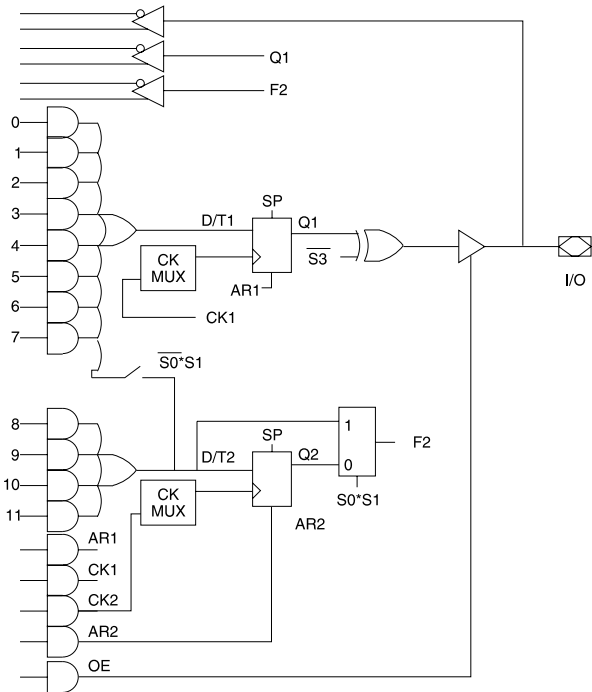

S2 = 0		Terms in		Output Configuration
S1	S0	D/T1	D/T2	
0	0	8	4	Registered (Q1); Q2 FB
1	0	12	4 <sup>(1)</sup>	Registered (Q1); Q2 FB
1	1	8	4	Registered (Q1); D/T2 FB

S3	Output Configuration
0	Active Low
1	Active High

S6	Q1 CLOCK
0	CK1
1	CK1 • PIN1

S4	Register 1 Type
0	D
1	T

S7	Q2 CLOCK
0	CK2
1	CK2 • PIN1

S5	Register 2 Type
0	D
1	T

## Output Logic, Combinatorial<sup>(1)</sup>

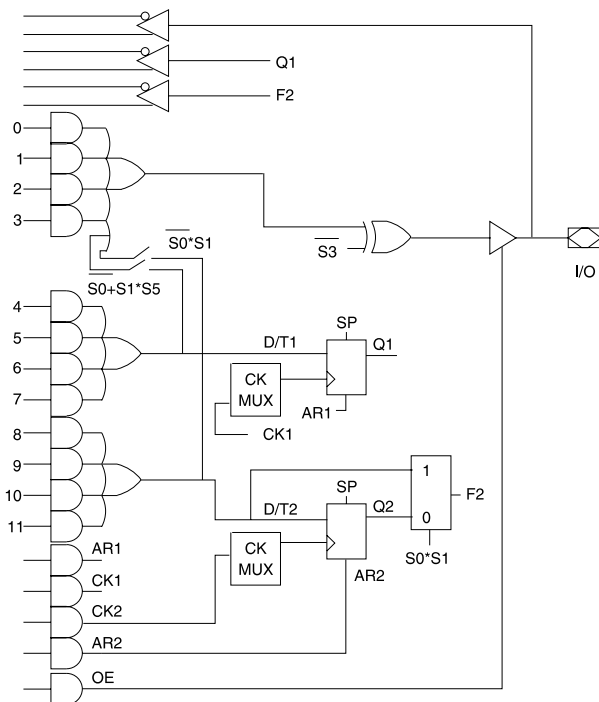

S2 = 1			Terms in		Output Configuration
S5	S1	S0	D/T1	D/T2	
X	0	0	4 <sup>(1)</sup>	4	Combinatorial (8 Terms); Q2 FB
X	0	1	4	4	Combinatorial (4 Terms); Q2 FB
X	1	0	4 <sup>(1)</sup>	4 <sup>(1)</sup>	Combinatorial (12 Terms); Q2 FB
1	1	1	4 <sup>(1)</sup>	4	Combinatorial (8 Terms); D/T2 FB
0	1	1	4	4	Combinatorial (4 Terms); D/T2 FB

Note: 1. These four terms are shared with D/T1.

## Clock Option

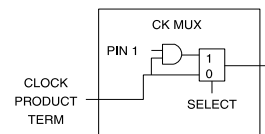

Note: 1. These diagrams show equivalent logic functions, not necessarily the actual circuit implementation.

## Absolute Maximum Ratings\*

Temperature Under Bias .....	-55°C to +125°C
Storage Temperature .....	-65°C to +150°C
Junction Temperature .....	150°C Max
Voltage on Any Pin with Respect to Ground .....	-2.0V to +7.0V <sup>(1)</sup>
Voltage on Input Pins with Respect to Ground During Programming.....	-2.0V to +14.0V <sup>(1)</sup>
Programming Voltage with Respect to Ground .....	-2.0V to +14.0V <sup>(1)</sup>

**\*NOTICE:** Stresses beyond those listed under “Absolute Maximum Ratings” may cause permanent damage to the device. This is a stress rating only and functional operation of the device at these or any other conditions beyond those indicated in the operational sections of this specification is not implied. Exposure to absolute maximum rating conditions for extended periods may affect device reliability.

**Note:** 1. Minimum voltage is -0.6V DC which may undershoot to -2.0V for pulses of less than 20 ns. Maximum output pin voltage is  $V_{CC} + 0.75V$  DC which may overshoot to +7.0V for pulses of less than 20 ns.

## DC and AC Operating Conditions

	Commercial	Industrial	Military
Operating Temperature	0°C - 70°C (Ambient)	-40°C - 85°C (Ambient)	-55°C - 125°C (Case)
$V_{CC}$ Power Supply	5V ± 5%	5V ± 10%	5V ± 10%

## Pin Capacitance

$f = 1 \text{ MHz}$ ,  $T = 25^\circ\text{C}^{(1)}$

	Typ	Max	Units	Conditions
$C_{IN}$	4	6	pF	$V_{IN} = 0V$
$C_{OUT}$	8	12	pF	$V_{OUT} = 0V$

**Note:** 1. Typical values for nominal supply voltage. This parameter is only sampled and is not 100% tested.

## Test Waveforms and Measurement Levels Output Test Load

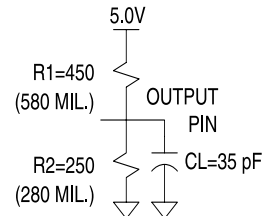
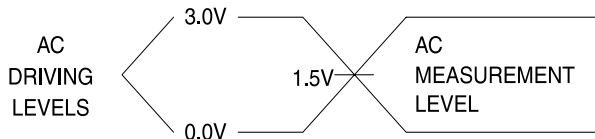



## AC Waveforms<sup>(1)</sup> Input Pin Clock

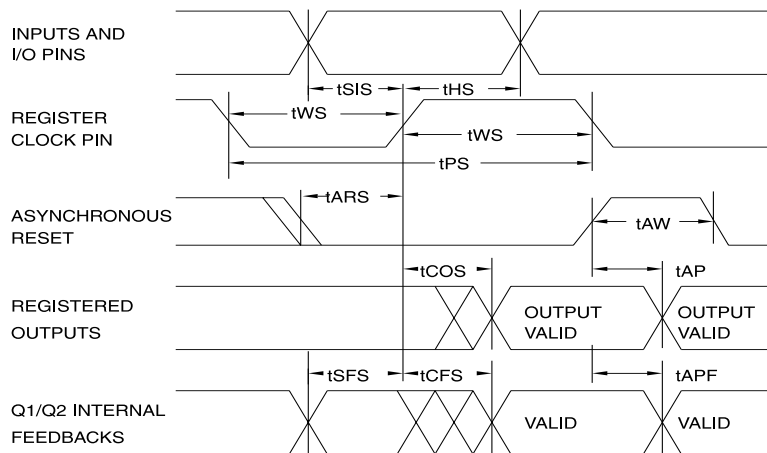

## AC Waveforms<sup>(1)</sup> Product Term Clock

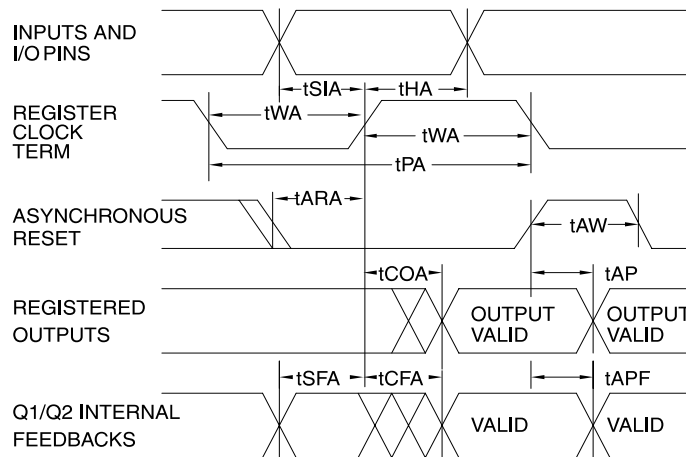

## AC Waveforms<sup>(1)</sup> Combinatorial Outputs and Feedback

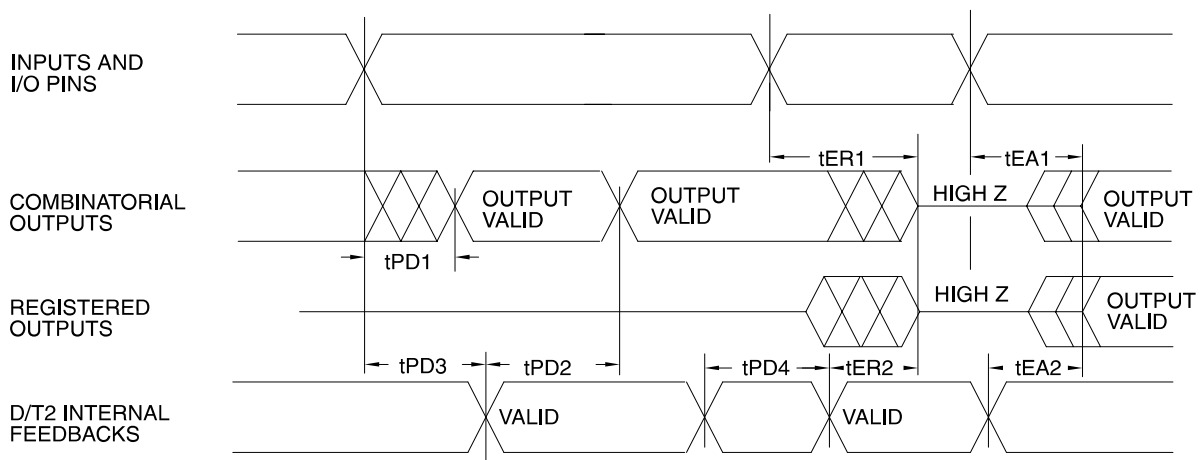

Note: 1. Timing measurement reference is 1.5V. Input AC driving levels are 0.0V and 3.0V, unless otherwise specified.

## ATF2500C DC Characteristics

Symbol	Parameter	Condition	Min	Typ	Max	Units	
$I_{IL}$	Input Load Current	$V_{IN} = -0.1V$ to $V_{CC} + 1V$			10	$\mu A$	
$I_{LO}$	Output Leakage Current	$V_{OUT} = -0.1V$ to $V_{CC} + 0.1V$			10	$\mu A$	
$I_{CC}$	Power Supply Current Standby	$V_{CC} = MAX$ , $V_{IN} = GND$ or $V_{CC} f = 0$ MHz, Outputs Open	ATF2500C	Com.	110	190	mA
				Ind., Mil.	110	210	mA
$I_{OS}$	Output Short Circuit Current	$V_{OUT} = 0.5V$			-120	mA	
$V_{IL}$	Input Low Voltage	$MIN \leq V_{CC} \leq MAX$	-0.6		0.8	V	
$V_{IH}$	Input High Voltage		2.0		$V_{CC} + 0.75$	V	
$V_{OL}$	Output Low Voltage	$V_{IN} = V_{IH}$ or $V_{IL}$ , $V_{CC} = 4.5V$	$I_{OL} = 8$ mA	Com., Ind.		0.5	V
			$I_{OL} = 6$ mA	Mil.		0.5	V
$V_{OH}$	Output High Voltage	$V_{CC} = MIN$	$I_{OH} = -100$ $\mu A$		$V_{CC} - 0.3$		V
			$I_{OH} = -4.0$ mA		2.4		

Note: 1. See  $I_{CC}$  versus frequency characterization curves.

## ATF2500C AC Characteristics

Symbol	Parameter	-10		-15		Units
		Min	Max	Min	Max	
$t_{PD1}$	Input to Non-registered Output		10		15	ns
$t_{PD2}$	Feedback to Non-registered Output		10		15	ns
$t_{PD3}$	Input to Non-registered Feedback		6		11	ns
$t_{PD4}$	Feedback to Non-registered Feedback		6		11	ns
$t_{EA1}$	Input to Output Enable		10		15	ns
$t_{ER1}$	Input to Output Disable		10		15	ns
$t_{EA2}$	Feedback to Output Enable		10		15	ns
$t_{ER2}$	Feedback to Output Disable		10		15	ns
$t_{AW}$	Asynchronous Reset Width	4		8		ns
$t_{AP}$	Asynchronous Reset to Registered Output		13		18	ns
$t_{APF}$	Asynchronous Reset to Registered Feedback		10		15	ns

**ATF2500C Register AC Characteristics, Input Pin Clock**

Symbol	Parameter	-10		-15		Units
		Min	Max	Min	Max	
$t_{COS}$	Clock to Output		5.5		10	ns
$t_{CFS}$	Clock to Feedback	0	2	0	5	ns
$t_{SIS}$	Input Setup Time	2		9		ns
$t_{SFS}$	Feedback Setup Time	2		9		ns
$t_{HS}$	Hold Time	0		0		ns
$t_{WS}$	Clock Width	3		6		ns
$t_{PS}$	Clock Period	8		12		ns
$F_{MAXS}$	External Feedback $1/(t_{SIS} + t_{COS})$		75		52	MHz
	Internal Feedback $1/(t_{SFS} + t_{CFS})$		100		71	MHz
	No Feedback $1/(t_{PS})$		110		83	MHz
$t_{ARS}$	Asynchronous Reset/Preset Recovery Time	5		12		ns

**ATF2500C Register AC Characteristics, Product Term Clock**

Symbol	Parameter	-10		-15		Units
		Min	Max	Min	Max	
$t_{COA}$	Clock to Output		10		15	ns
$t_{CFA}$	Clock to Feedback	2	5	5	12	ns
$t_{SIA}$	Input Setup Time	2		5		ns
$t_{SFA}$	Feedback Setup Time	2		5		ns
$t_{HA}$	Hold Time	1		5		ns
$t_{WA}$	Clock Width	3		7.5		ns
$t_{PA}$	Clock Period	9		15		ns
$F_{MAXA}$	External Feedback $1/(t_{SIA} + t_{COA})$		75.5		50	MHz
	Internal Feedback $1/(t_{SFA} + t_{CFA})$		100		58	MHz
	No Feedback $1/(t_{PS})$		100		66	MHz
$t_{ARA}$	Asynchronous Reset/Preset Recovery Time	2		8		ns

**STAND-BY  $I_{CC}$  VS.  
SUPPLY VOLTAGE ( $T_A = 25^\circ\text{C}$ )**

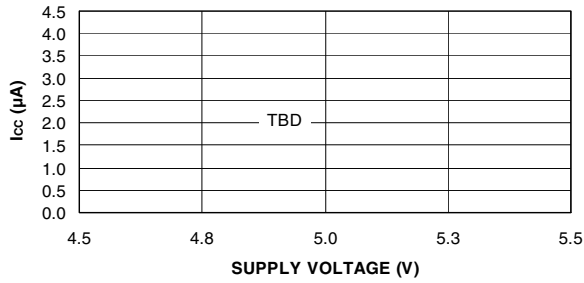

**NORMALIZED  $I_{CC}$  VS. TEMP**

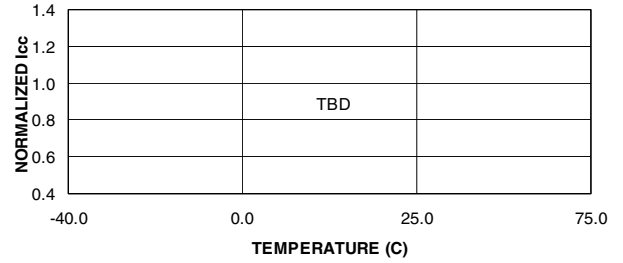

**SUPPLY CURRENT VS.  
INPUT FREQUENCY ( $V_{CC} = 5.0\text{V}$ ,  $T_A = 25^\circ\text{C}$ )**

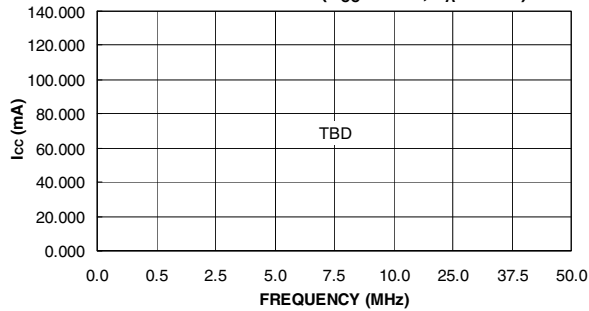

**SUPPLY CURRENT VS.  
INPUT FREQUENCY ( $V_{CC} = 5.0\text{V}$ ,  $T_A = 25^\circ\text{C}$ )**

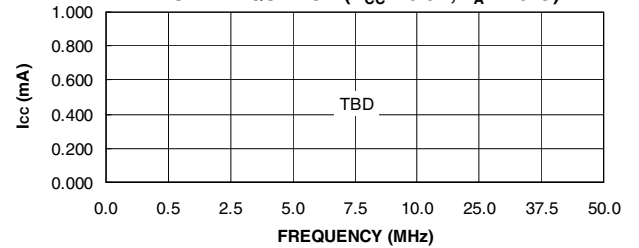

**OUTPUT SOURCE CURRENT VS.  
SUPPLY VOLTAGE ( $V_{OH} = 2.4\text{V}$ )**

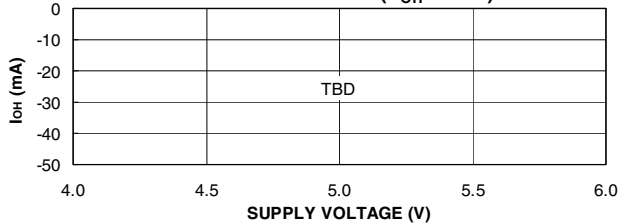

**OUTPUT SOURCE CURRENT VS.  
OUTPUT VOLTAGE ( $V_{CC} = 5.0\text{V}$ ,  $T_A = 25^\circ\text{C}$ )**

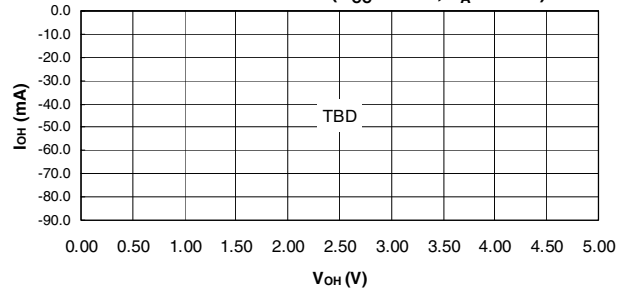

**OUTPUT SINK CURRENT VS.  
SUPPLY VOLTAGE ( $V_{OL} = 0.5\text{V}$ )**

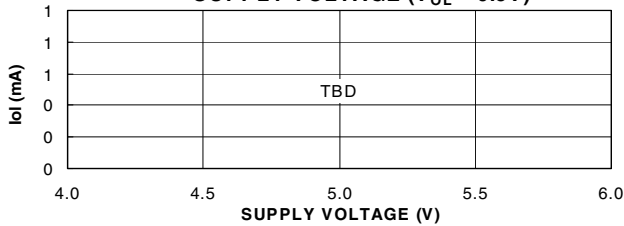

**OUTPUT SINK CURRENT VS.  
OUTPUT VOLTAGE ( $V_{CC} = 5.0\text{V}$ ,  $T_A = 25^\circ\text{C}$ )**

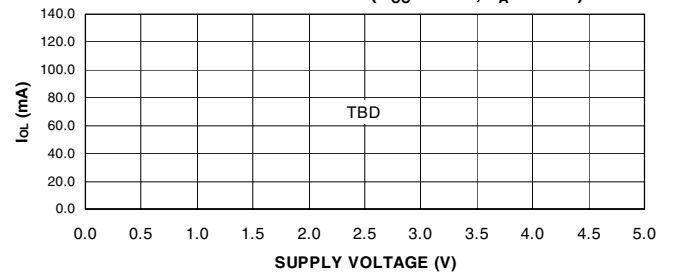

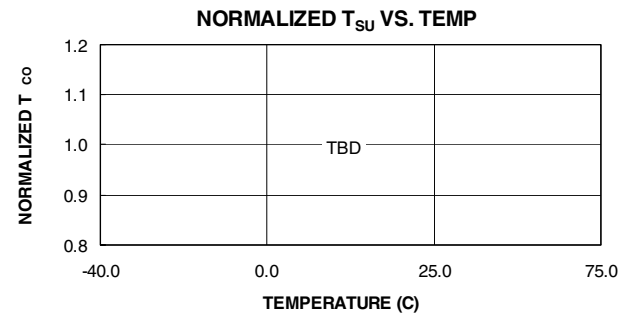
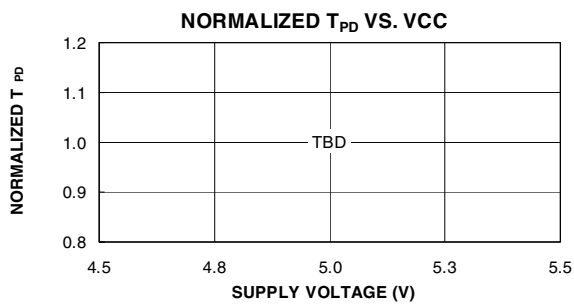
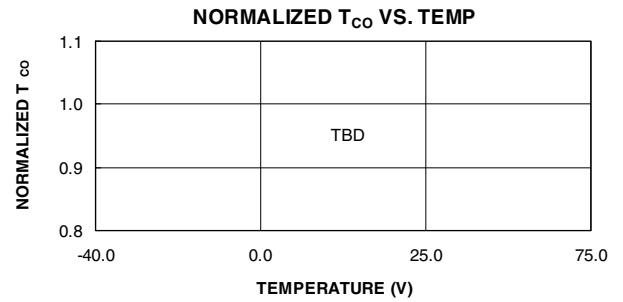
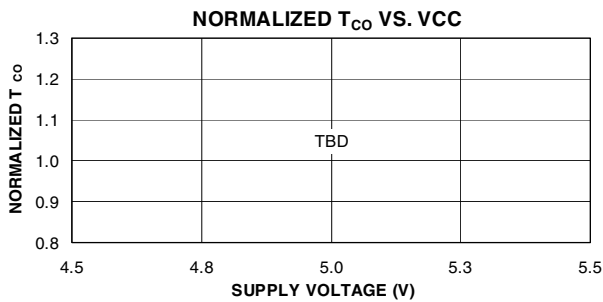
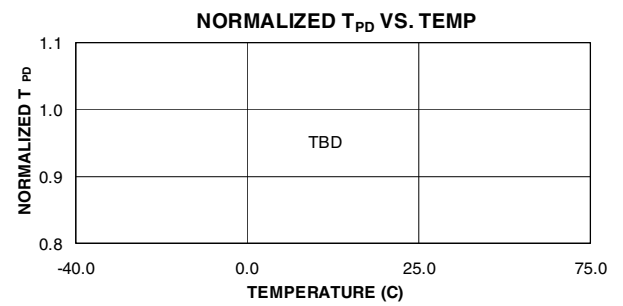
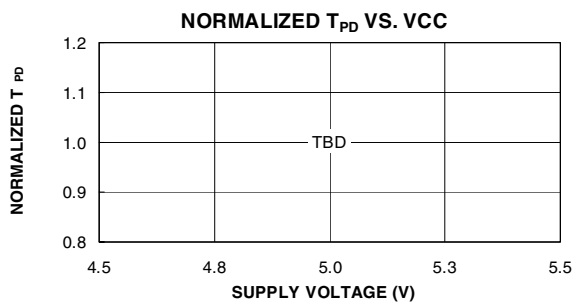
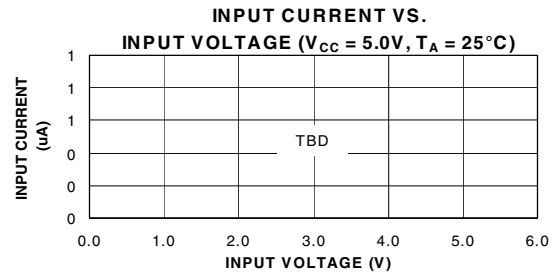
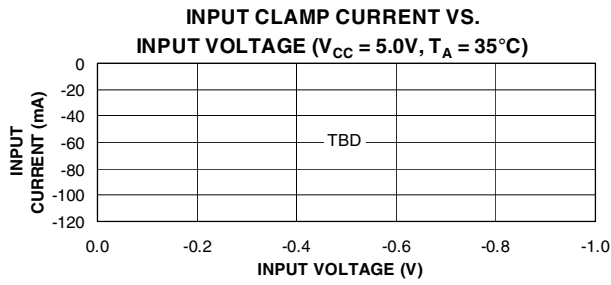

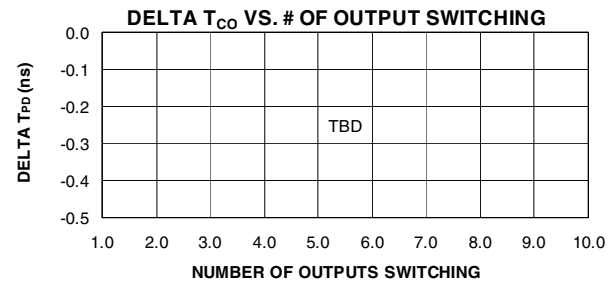
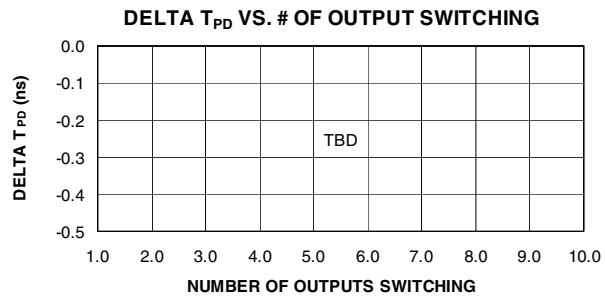
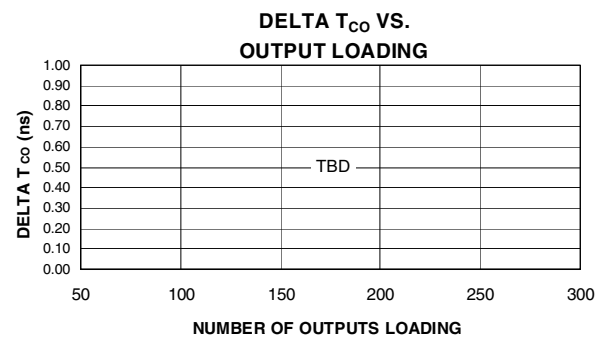
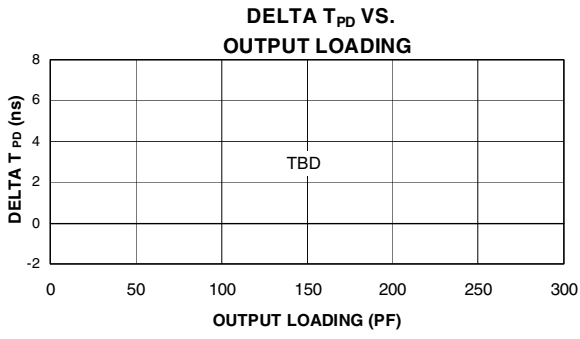

## ATF2500CL DC Characteristics

Symbol	Parameter	Condition	Min	Typ	Max	Units	
$I_{IL}$	Input Load Current	$V_{IN} = -0.1V$ to $V_{CC} + 1V$			10	$\mu A$	
$I_{LO}$	Output Leakage Current	$V_{OUT} = -0.1V$ to $V_{CC} + 0.1V$			10	$\mu A$	
$I_{CC}$	Power Supply Current Standby	$V_{CC} = MAX$ , $V_{IN} = GND$ or $V_{CC} f = 0$ MHz, Outputs Open	ATF2500CL	Com.	2	5	mA
				Ind., Mil.	2	10	mA
$I_{OS}$	Output Short Circuit Current	$V_{OUT} = 0.5V$			-120	mA	
$V_{IL}$	Input Low Voltage	$MIN \leq V_{CC} \leq MAX$	-0.6		0.8	V	
$V_{IH}$	Input High Voltage		2.0		$V_{CC} + 0.75$	V	
$V_{OL}$	Output Low Voltage	$V_{IN} = V_{IH}$ or $V_{IL}$ , $V_{CC} = 4.5V$	$I_{OL} = 8$ mA	Com., Ind.		0.5	V
			$I_{OL} = 6$ mA	Mil.		0.5	V
$V_{OH}$	Output High Voltage	$V_{CC} = MIN$	$I_{OH} = -100$ $\mu A$		$V_{CC} - 0.3$		V
			$I_{OH} = -4.0$ mA		2.4		

Note: 1. See  $I_{CC}$  versus frequency characterization curves.

## ATF2500CL AC Characteristics

Symbol	Parameter	-20		Units
		Min	Max	
$t_{PD1}$	Input to Non-registered Output		20	ns
$t_{PD2}$	Feedback to Non-registered Output		20	ns
$t_{PD3}$	Input to Non-registered Feedback		15	ns
$t_{PD4}$	Feedback to Non-registered Feedback		15	ns
$t_{EA1}$	Input to Output Enable		20	ns
$t_{ER1}$	Input to Output Disable		20	ns
$t_{EA2}$	Feedback to Output Enable		20	ns
$t_{ER2}$	Feedback to Output Disable		20	ns
$t_{AW}$	Asynchronous Reset Width	12		ns
$t_{AP}$	Asynchronous Reset to Registered Output		22	ns
$t_{APF}$	Asynchronous Reset to Registered Feedback		19	ns



## ATF2500CL Register AC Characteristics, Input Pin Clock

Symbol	Parameter	-20		Units
		Min	Max	
$t_{COS}$	Clock to Output		11	ns
$t_{CFS}$	Clock to Feedback	0	6	ns
$t_{SIS}$	Input Setup Time	14		ns
$t_{SFS}$	Feedback Setup Time	14		ns
$t_{HS}$	Hold Time	0		ns
$t_{WS}$	Clock Width	7		ns
$t_{PS}$	Clock Period	14		ns
$F_{MAXS}$	External Feedback $1/(t_{SIS} + t_{COS})$		40	MHz
	Internal Feedback $1/(t_{SFS} + t_{CFS})$		50	MHz
	No Feedback $1/(t_{PS})$		71	MHz
$t_{ARS}$	Asynchronous Reset/Preset Recovery Time	15		ns

## ATF2500CL Register AC Characteristics, Product Term Clock

Symbol	Parameter	-20		Units
		Min	Max	
$t_{COA}$	Clock to Output		20	ns
$t_{CFA}$	Clock to Feedback	10	16	ns
$t_{SIA}$	Input Setup Time	10		ns
$t_{SFA}$	Feedback Setup Time	8		ns
$t_{HA}$	Hold Time	10		ns
$t_{WA}$	Clock Width	11		ns
$t_{PA}$	Clock Period	22		ns
$F_{MAXA}$	External Feedback $1/(t_{SIA} + t_{COA})$		33	MHz
	Internal Feedback $1/(t_{SFA} + t_{CFA})$		38	MHz
	No Feedback $1/(t_{PS})$		45	MHz
$t_{ARA}$	Asynchronous Reset/Preset Recovery Time	12		ns



**STAND-BY  $I_{CC}$  VS.  
SUPPLY VOLTAGE ( $T_A = 25^\circ\text{C}$ )**

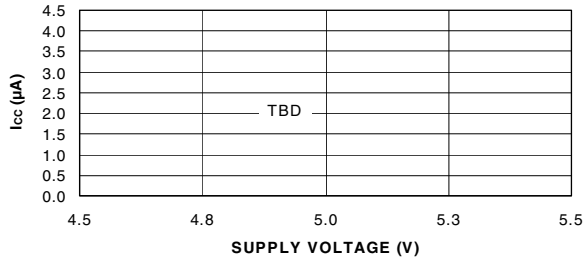

**NORMALIZED  $I_{CC}$  VS. TEMP**

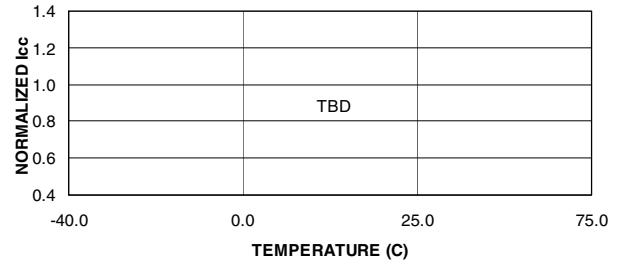

**SUPPLY CURRENT VS.  
INPUT FREQUENCY ( $V_{CC} = 5.0\text{V}$ ,  $T_A = 25^\circ\text{C}$ )**

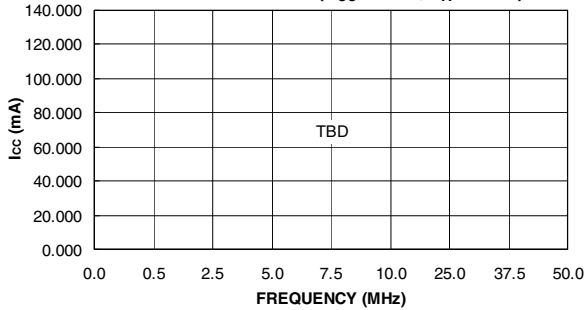

**SUPPLY CURRENT VS.  
INPUT FREQUENCY ( $V_{CC} = 5.0\text{V}$ ,  $T_A = 25^\circ\text{C}$ )**

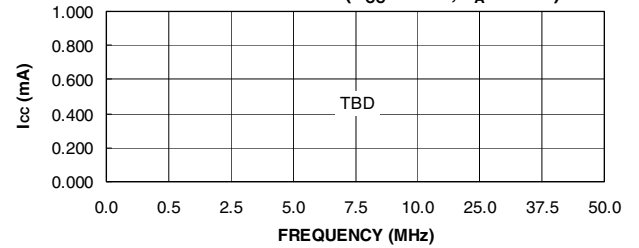

**OUTPUT SOURCE CURRENT VS.  
SUPPLY VOLTAGE ( $V_{OH} = 2.4\text{V}$ )**

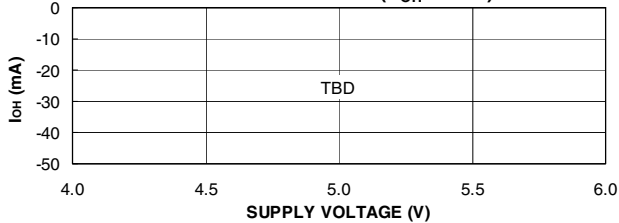

**OUTPUT SOURCE CURRENT VS.  
OUTPUT VOLTAGE ( $V_{CC} = 5.0\text{V}$ ,  $T_A = 25^\circ\text{C}$ )**

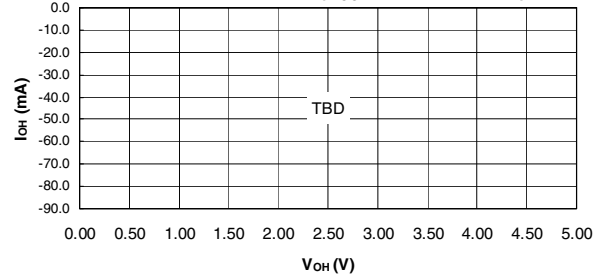

**OUTPUT SINK CURRENT VS.  
SUPPLY VOLTAGE ( $V_{OL} = 0.5\text{V}$ )**

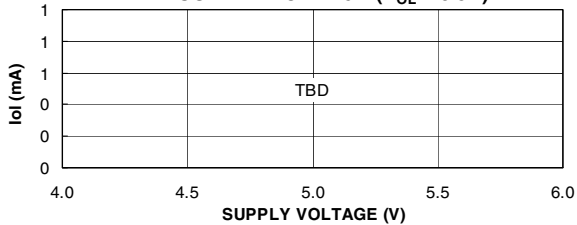

**OUTPUT SINK CURRENT VS.  
OUTPUT VOLTAGE ( $V_{CC} = 5.0\text{V}$ ,  $T_A = 25^\circ\text{C}$ )**

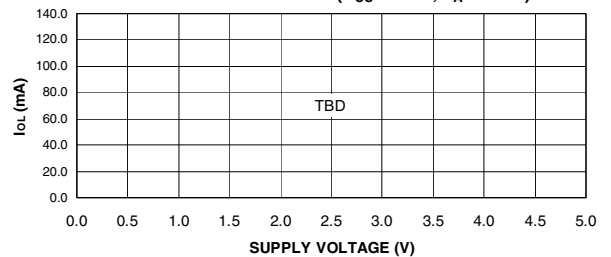

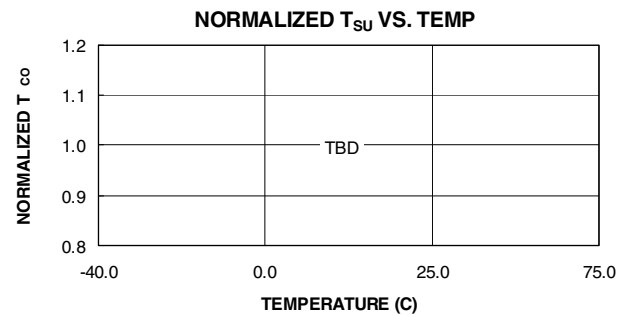
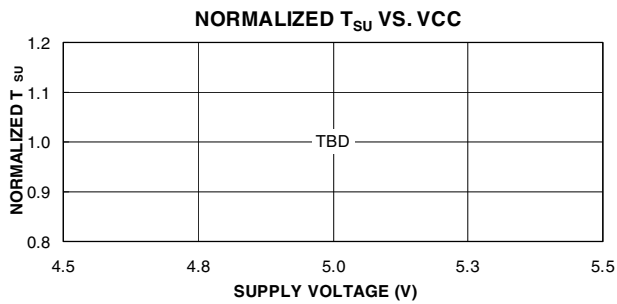
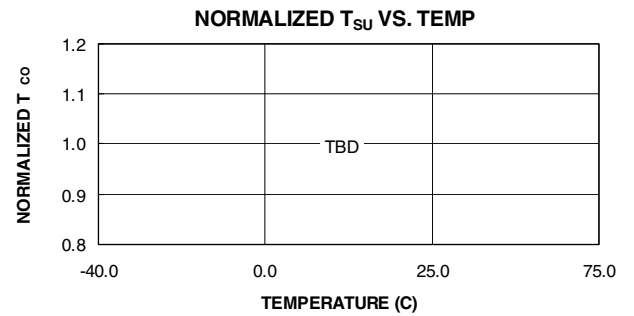
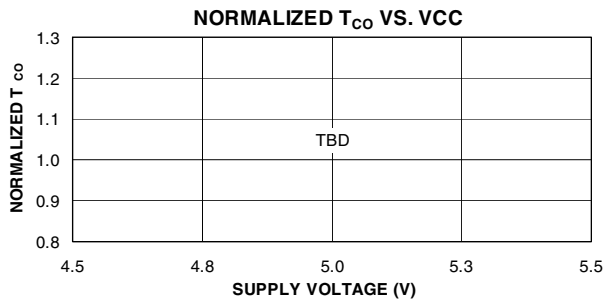
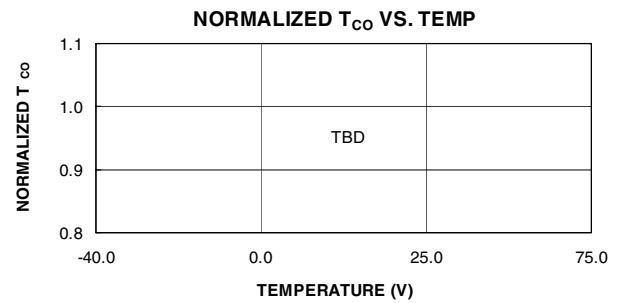
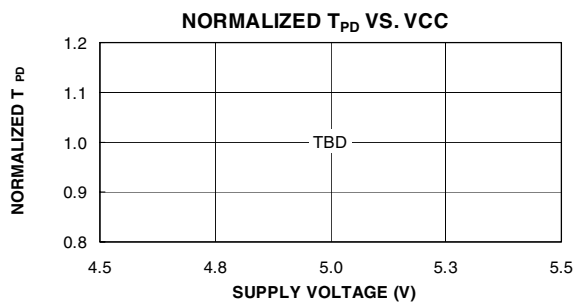
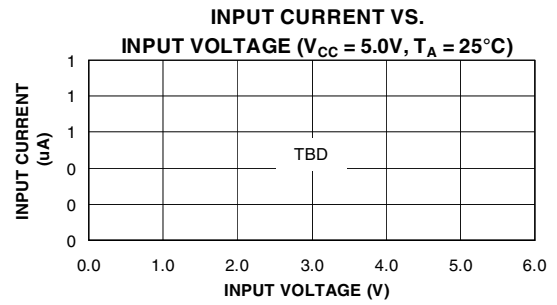
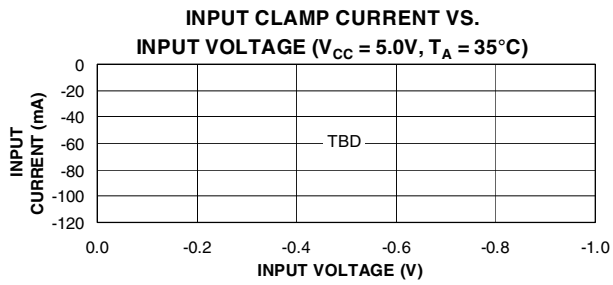

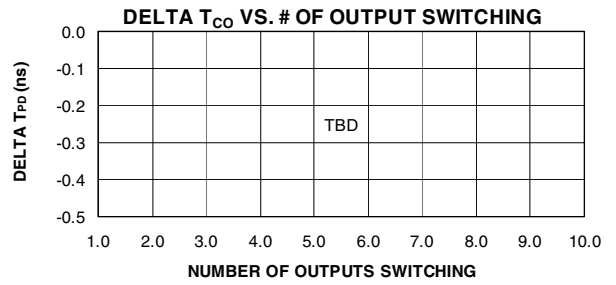
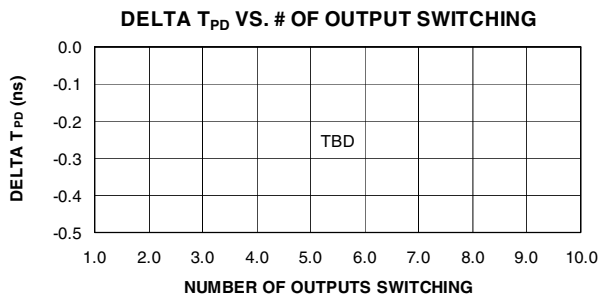
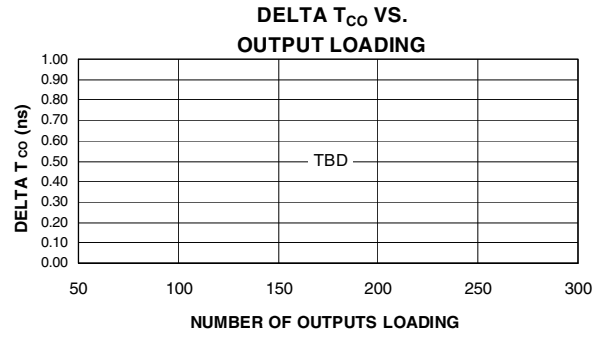
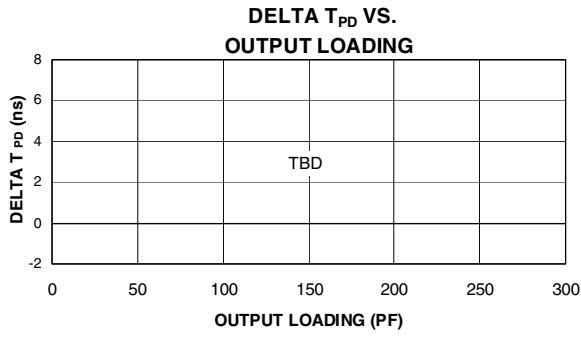



## ATF2500CQ DC Characteristics

Symbol	Parameter	Condition		Min	Typ	Max	Units
$I_{IL}$	Input Load Current	$V_{IN} = -0.1V$ to $V_{CC} + 1V$				10	$\mu A$
$I_{LO}$	Output Leakage Current	$V_{OUT} = -0.1V$ to $V_{CC} + 0.1V$				10	$\mu A$
$I_{CC}$	Power Supply Current Standby	$V_{CC} = MAX,$ $V_{IN} = GND$ or $V_{CC} f = 0$ MHz, Outputs Open	ATF2500CQ	Com.	30	70	mA
				Ind., Mil.	30	85	mA
$I_{OS}$	Output Short Circuit Current	$V_{OUT} = 0.5V$				-120	mA
$V_{IL}$	Input Low Voltage	$MIN \leq V_{CC} \leq MAX$		-0.6		0.8	V
$V_{IH}$	Input High Voltage			2.0		$V_{CC} + 0.75$	V
$V_{OL}$	Output Low Voltage	$V_{IN} = V_{IH}$ or $V_{IL},$ $V_{CC} = 4.5V$	$I_{OL} = 8$ mA	Com., Ind.		0.5	V
			$I_{OL} = 6$ mA	Mil.		0.5	V
$V_{OH}$	Output High Voltage	$V_{CC} = MIN$	$I_{OH} = -100$ $\mu A$		$V_{CC} - 0.3$		V
			$I_{OH} = -4.0$ mA		2.4		

Note: 1. See  $I_{CC}$  versus frequency characterization curves.

## ATF2500CQ AC Characteristics

Symbol	Parameter	-20		Units
		Min	Max	
$t_{PD1}$	Input to Non-registered Output		20	ns
$t_{PD2}$	Feedback to Non-registered Output		20	ns
$t_{PD3}$	Input to Non-registered Feedback		15	ns
$t_{PD4}$	Feedback to Non-registered Feedback		15	ns
$t_{EA1}$	Input to Output Enable		20	ns
$t_{ER1}$	Input to Output Disable		20	ns
$t_{EA2}$	Feedback to Output Enable		20	ns
$t_{ER2}$	Feedback to Output Disable		20	ns
$t_{AW}$	Asynchronous Reset Width	12		ns
$t_{AP}$	Asynchronous Reset to Registered Output		22	ns
$t_{APF}$	Asynchronous Reset to Registered Feedback		19	ns

**ATF2500CQ Register AC Characteristics, Input Pin Clock**

Symbol	Parameter	-20		Units
		Min	Max	
$t_{COS}$	Clock to Output		11	ns
$t_{CFS}$	Clock to Feedback	0	6	ns
$t_{SIS}$	Input Setup Time	14		ns
$t_{SFS}$	Feedback Setup Time	14		ns
$t_{HS}$	Hold Time	0		ns
$t_{WS}$	Clock Width	7		ns
$t_{PS}$	Clock Period	14		ns
$F_{MAXS}$	External Feedback $1/(t_{SIS} + t_{COS})$		40	MHz
	Internal Feedback $1/(t_{SFS} + t_{CFS})$		50	MHz
	No Feedback $1/(t_{PS})$		71	MHz
$t_{ARS}$	Asynchronous Reset/Preset Recovery Time	15		ns

**ATF2500CQ Register AC Characteristics, Product Term Clock**

Symbol	Parameter	-20		Units
		Min	Max	
$t_{COA}$	Clock to Output		20	ns
$t_{CFA}$	Clock to Feedback	10	16	ns
$t_{SIA}$	Input Setup Time	10		ns
$t_{SFA}$	Feedback Setup Time	8		ns
$t_{HA}$	Hold Time	10		ns
$t_{WA}$	Clock Width	11		ns
$t_{PA}$	Clock Period	22		ns
$F_{MAXA}$	External Feedback $1/(t_{SIA} + t_{COA})$		33	MHz
	Internal Feedback $1/(t_{SFA} + t_{CFA})$		38	MHz
	No Feedback $1/(t_{PS})$		45	MHz
$t_{ARA}$	Asynchronous Reset/Preset Recovery Time	12		ns

**STAND-BY  $I_{CC}$  VS.  
SUPPLY VOLTAGE ( $T_A = 25^\circ\text{C}$ )**

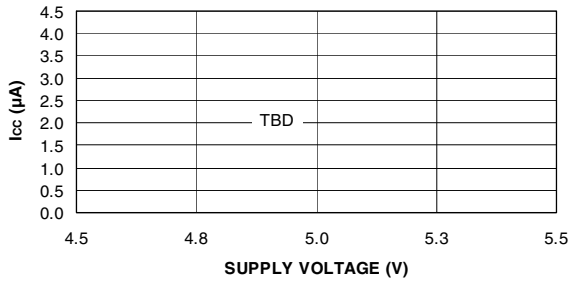

**NORMALIZED  $I_{CC}$  VS. TEMP**

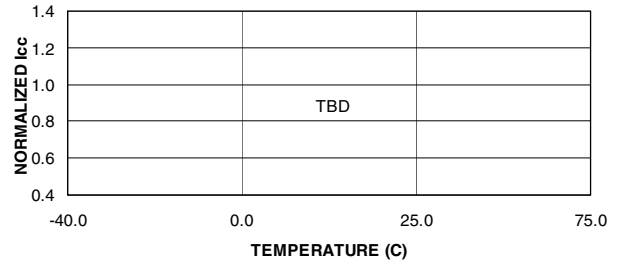

**SUPPLY CURRENT VS.  
INPUT FREQUENCY ( $V_{CC} = 5.0\text{V}$ ,  $T_A = 25^\circ\text{C}$ )**

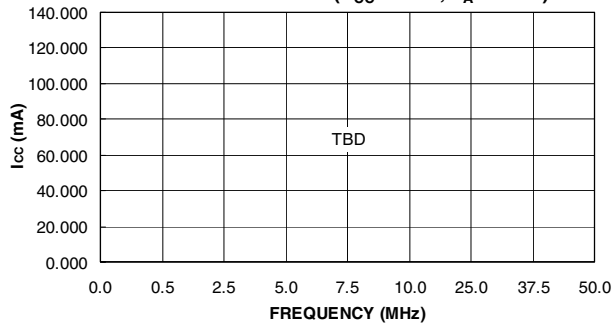

**SUPPLY CURRENT VS.  
INPUT FREQUENCY ( $V_{CC} = 5.0\text{V}$ ,  $T_A = 25^\circ\text{C}$ )**

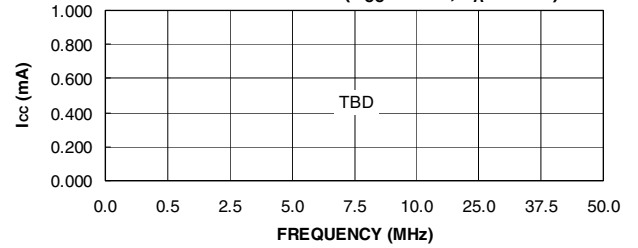

**OUTPUT SOURCE CURRENT VS.  
SUPPLY VOLTAGE ( $V_{OH} = 2.4\text{V}$ )**

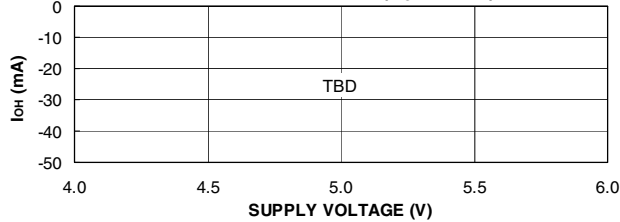

**OUTPUT SOURCE CURRENT VS.  
OUTPUT VOLTAGE ( $V_{CC} = 5.0\text{V}$ ,  $T_A = 25^\circ\text{C}$ )**

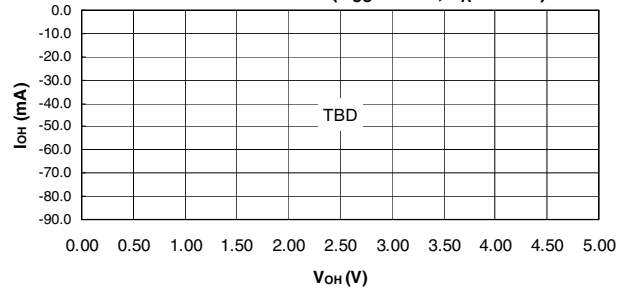

**OUTPUT SINK CURRENT VS.  
SUPPLY VOLTAGE ( $V_{OL} = 0.5\text{V}$ )**

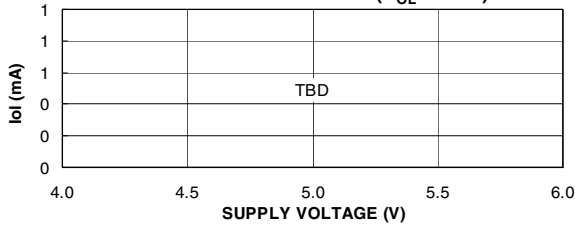

**OUTPUT SINK CURRENT VS.  
OUTPUT VOLTAGE ( $V_{CC} = 5.0\text{V}$ ,  $T_A = 25^\circ\text{C}$ )**

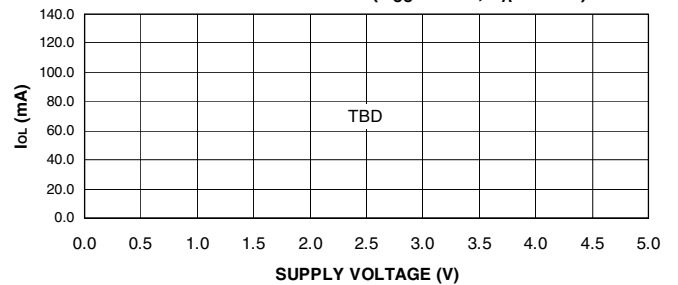

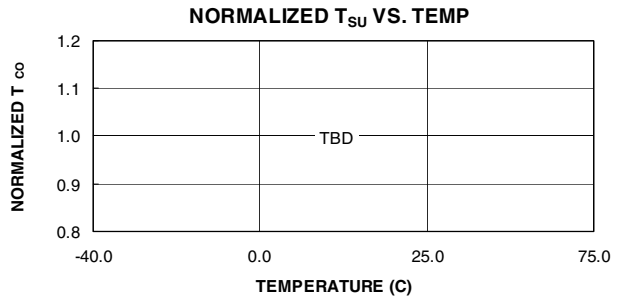
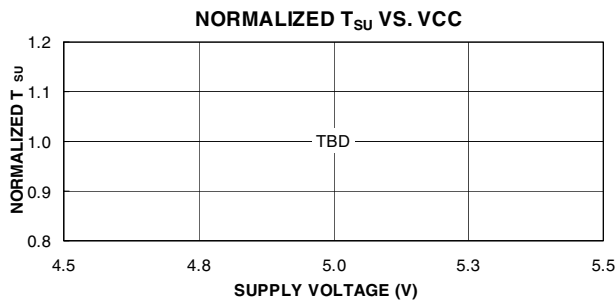
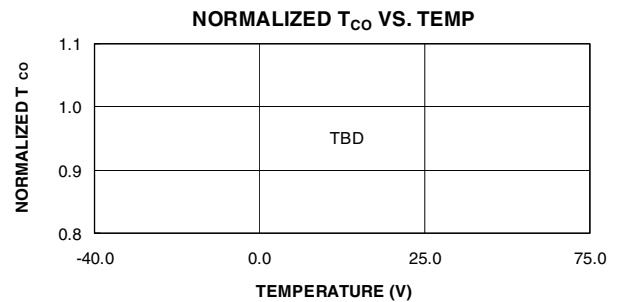
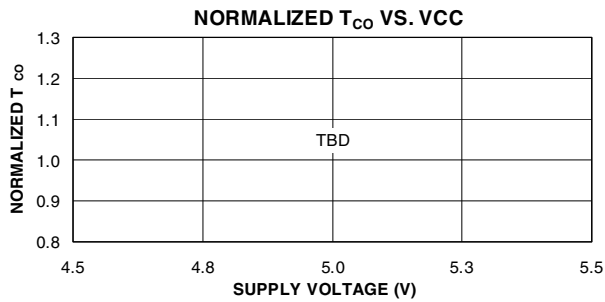
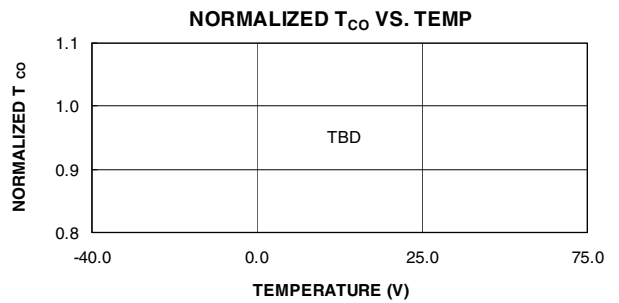
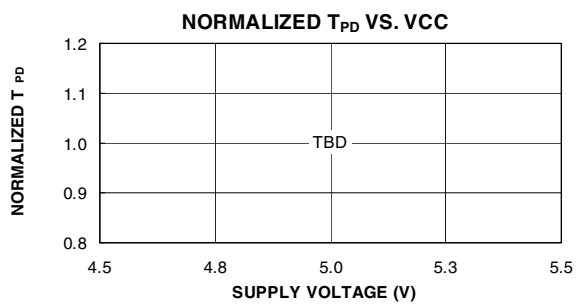
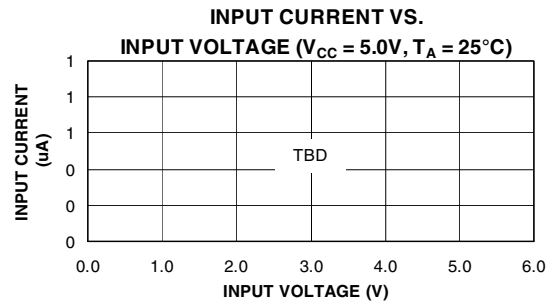
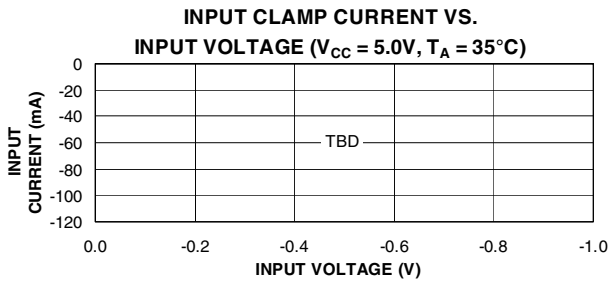

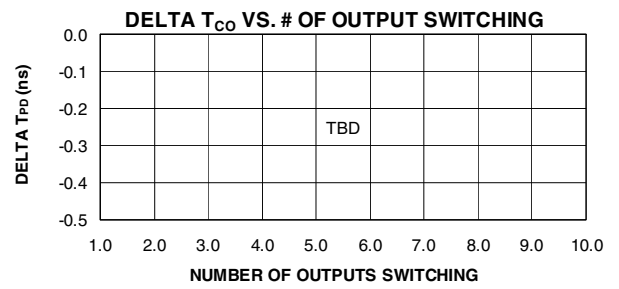
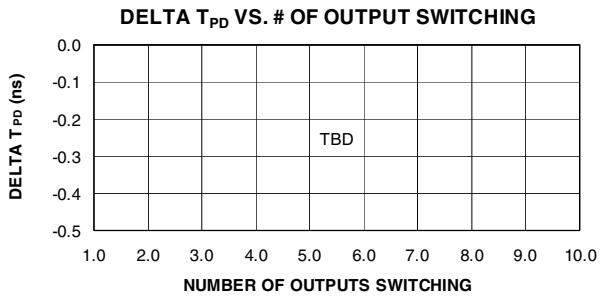
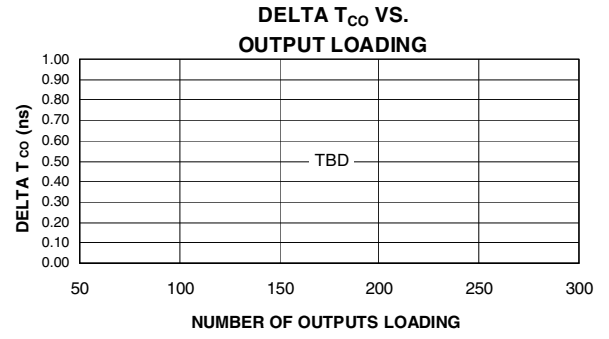
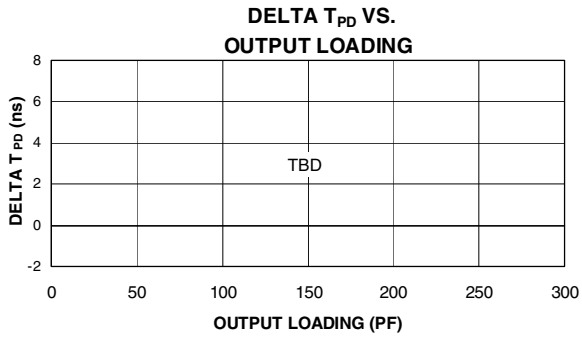



## ATF2500CQL DC Characteristics

Symbol	Parameter	Condition			Min	Typ	Max	Units
$I_{IL}$	Input Load Current	$V_{IN} = -0.1V$ to $V_{CC} + 1V$					10	$\mu A$
$I_{LO}$	Output Leakage Current	$V_{OUT} = -0.1V$ to $V_{CC} + 0.1V$					10	$\mu A$
$I_{CC}$	Power Supply Current Standby	$V_{CC} = MAX,$ $V_{IN} = GND$ or $V_{CC} f = 0$ MHz, Outputs Open	ATF2500CQL	Com.		2	4	mA
				Ind., Mil.		2	5	mA
$I_{OS}$	Output Short Circuit Current	$V_{OUT} = 0.5V$					-120	mA
$V_{IL}$	Input Low Voltage	$MIN \leq V_{CC} \leq MAX$			-0.6		0.8	V
$V_{IH}$	Input High Voltage				2.0		$V_{CC} + 0.75$	V
$V_{OL}$	Output Low Voltage	$V_{IN} = V_{IH}$ or $V_{IL},$ $V_{CC} = 4.5V$	$I_{OL} = 8$ mA	Com., Ind.			0.5	V
			$I_{OL} = 6$ mA	Mil.			0.5	V
$V_{OH}$	Output High Voltage	$V_{CC} = MIN$	$I_{OH} = -100$ $\mu A$		$V_{CC} - 0.3$			V
			$I_{OH} = -4.0$ mA		2.4			

## ATF2500CQL AC Characteristics

Symbol	Parameter	-25		Units
		Min	Max	
$t_{PD1}$	Input to Non-registered Output		25	ns
$t_{PD2}$	Feedback to Non-registered Output		25	ns
$t_{PD3}$	Input to Non-registered Feedback		18	ns
$t_{PD4}$	Feedback to Non-registered Feedback		18	ns
$t_{EA1}$	Input to Output Enable		25	ns
$t_{ER1}$	Input to Output Disable		25	ns
$t_{EA2}$	Feedback to Output Enable		25	ns
$t_{ER2}$	Feedback to Output Disable		25	ns
$t_{AW}$	Asynchronous Reset Width	15		ns
$t_{AP}$	Asynchronous Reset to Registered Output		28	ns
$t_{APF}$	Asynchronous Reset to Registered Feedback		25	ns

## ATF2500CQL Register AC Characteristics, Input Pin Clock

Symbol	Parameter	-25		Units
		Min	Max	
$t_{COS}$	Clock to Output		12	ns
$t_{CFS}$	Clock to Feedback	0	7	ns
$t_{SIS}$	Input Setup Time	20		ns
$t_{SFS}$	Feedback Setup Time	20		ns
$t_{HS}$	Hold Time	0		ns
$t_{WS}$	Clock Width	8		ns
$t_{PS}$	Clock Period	146		ns
$F_{MAXS}$	External Feedback $1/(t_{SIS} + t_{COS})$		31	MHz
	Internal Feedback $1/(t_{SFS} + t_{CFS})$		37	MHz
	No Feedback $1/(t_{PS})$		62	MHz
$t_{ARS}$	Asynchronous Reset/Preset Recovery Time	20		ns

## ATF2500CQL Register AC Characteristics, Product Term Clock

Symbol	Parameter	-25		Units
		Min	Max	
$t_{COA}$	Clock to Output		22	ns
$t_{CFA}$	Clock to Feedback	12	18	ns
$t_{SIA}$	Input Setup Time	15		ns
$t_{SFA}$	Feedback Setup Time	10		ns
$t_{HA}$	Hold Time	12		ns
$t_{WA}$	Clock Width	14		ns
$t_{PA}$	Clock Period	28		ns
$F_{MAXA}$	External Feedback $1/(t_{SIA} + t_{COA})$		27	MHz
	Internal Feedback $1/(t_{SFA} + t_{CFA})$		36	MHz
	No Feedback $1/(t_{PS})$		36	MHz
$t_{ARA}$	Asynchronous Reset/Preset Recovery Time	15		ns

**STAND-BY  $I_{CC}$  VS.  
SUPPLY VOLTAGE ( $T_A = 25^\circ\text{C}$ )**

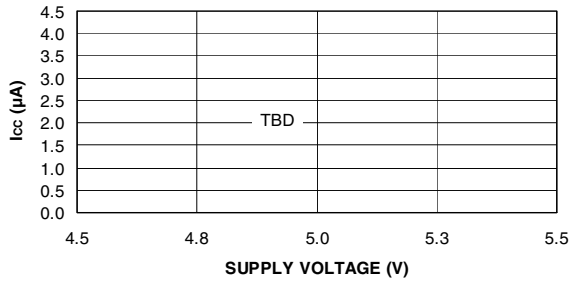

**NORMALIZED  $I_{CC}$  VS. TEMP**

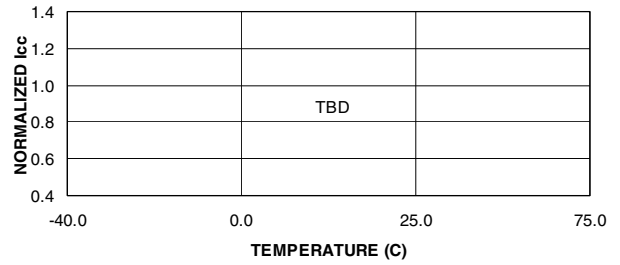

**SUPPLY CURRENT VS.  
INPUT FREQUENCY ( $V_{CC} = 5.0\text{V}$ ,  $T_A = 25^\circ\text{C}$ )**

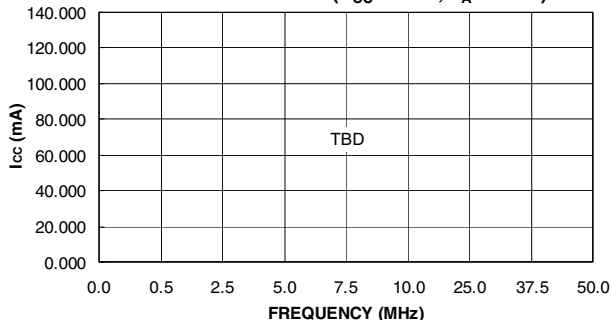

**SUPPLY CURRENT VS.  
INPUT FREQUENCY ( $V_{CC} = 5.0\text{V}$ ,  $T_A = 25^\circ\text{C}$ )**

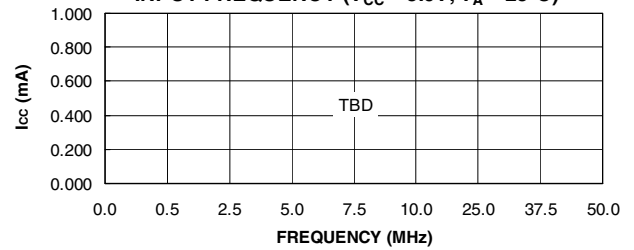

**OUTPUT SOURCE CURRENT VS.  
SUPPLY VOLTAGE ( $V_{OH} = 2.4\text{V}$ )**

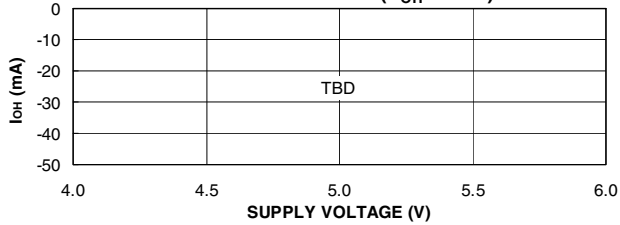

**OUTPUT SOURCE CURRENT VS.  
OUTPUT VOLTAGE ( $V_{CC} = 5.0\text{V}$ ,  $T_A = 25^\circ\text{C}$ )**

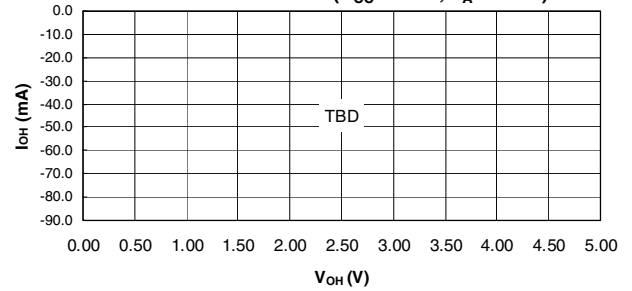

**OUTPUT SINK CURRENT VS.  
SUPPLY VOLTAGE ( $V_{OL} = 0.5\text{V}$ )**

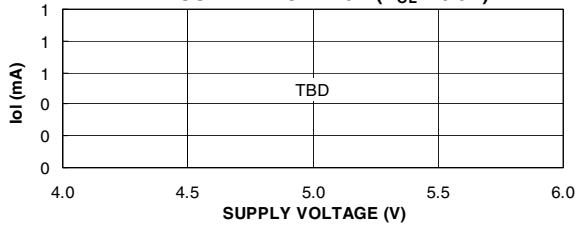

**OUTPUT SINK CURRENT VS.  
OUTPUT VOLTAGE ( $V_{CC} = 5.0\text{V}$ ,  $T_A = 25^\circ\text{C}$ )**

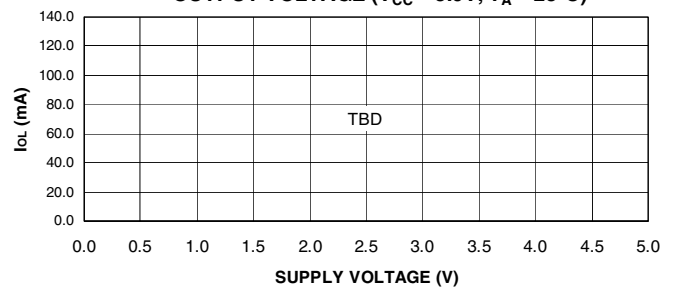

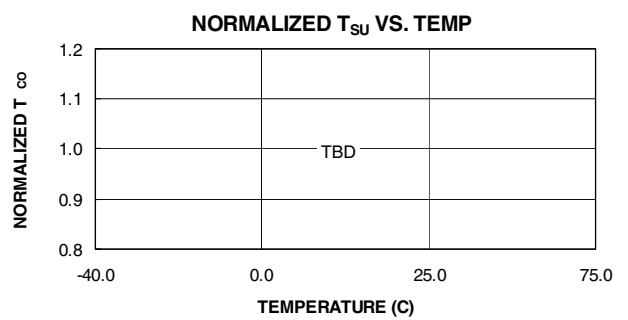
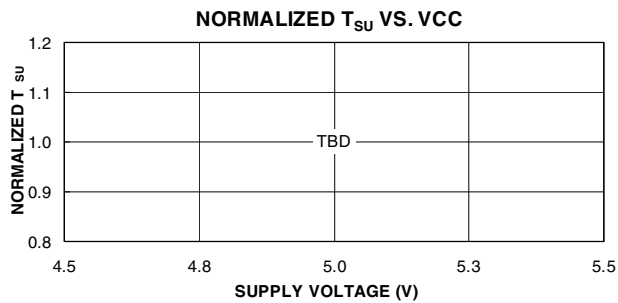
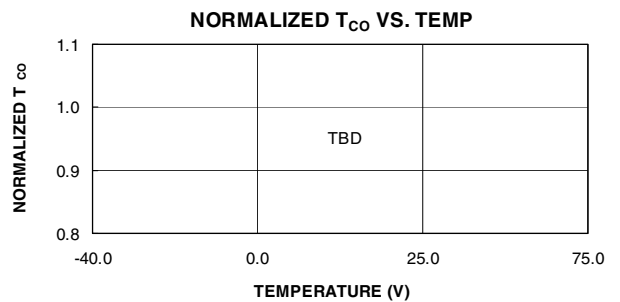
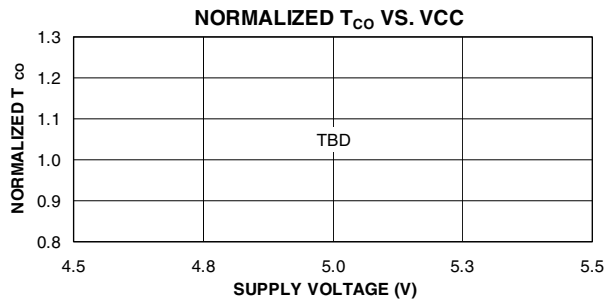
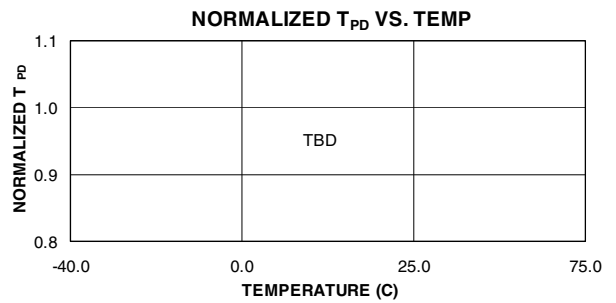
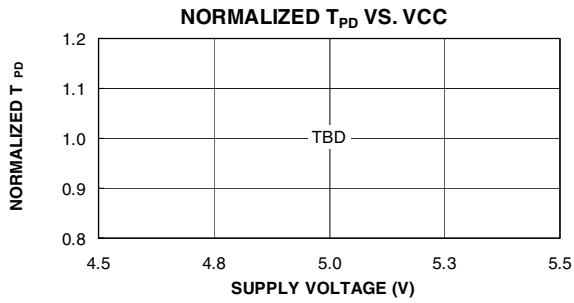
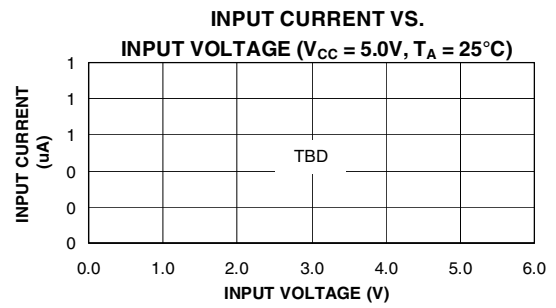
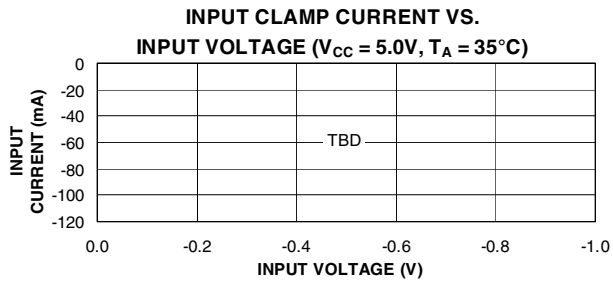

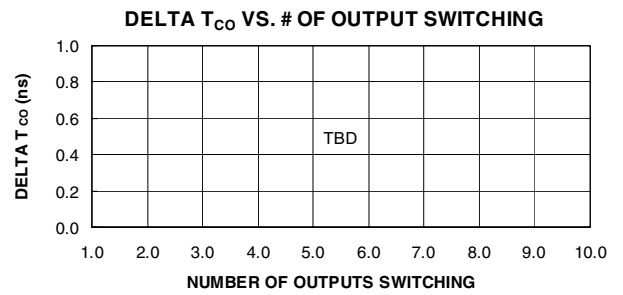
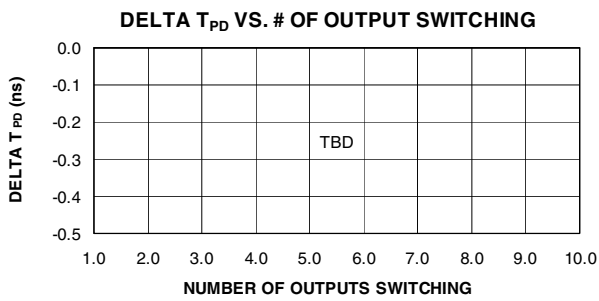
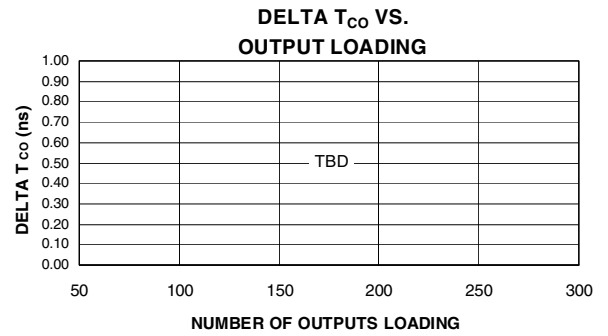
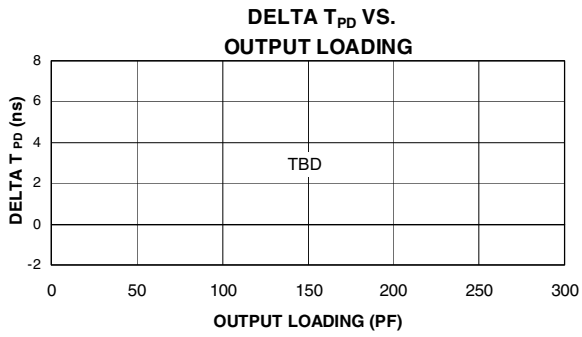



## Ordering Information

$t_{PD}$ (ns)	$t_{COS}$ (ns)	Ext. $f_{MAXS}$ (MHz)	Ordering Code	Package	Operation Range
120	5.5	75	ATF2500C-10JC	44J	Commercial
15	10	52	ATF2500C-15JC	44J	Commercial (0°C to 70°C)
			ATF2500C-15JI	44J	Industrial (-40°C to 85°C)
			ATF2500C-15KM/883 ATF2500C-15NM/883	44K 44L	Military/883C (-55°C to 125°C) Class B, Fully Compliant
			5962 - 0152201M4X 5962 - 0152201M3X	44K 44L	Military/883C (-55°C to 125°C) Class B, Fully Compliant
20	11	40	ATF2500CL-20JC	44J	Commercial (0°C to 70°C)
			ATF2500CL-20JI	44J	Industrial (-40°C to 85°C)
			ATF2500CL-20KM/883 ATF2500CL-20NM/883	44K 44L	Military/883C (-55°C to 125°C) Class B, Fully Compliant
			5962 - 0152202M4X 5962 - 0152202M3X	44K 44L	Military/883C (-55°C to 125°C) Class B, Fully Compliant
20	11	40	ATF2500CQ-20JC ATF2500CQ-20PC	44J 40P6	Commercial (0°C to 70°C)
			ATF2500CQ-20JI ATF2500CQ-20PI	44J 40P6	Industrial (-40°C to 85°C)
			ATF2500CQ-20GM/883 ATF2500CQ-20KM/883 ATF2500CQ-20NM/883	40D6 44K 44L	Military/883C (-55°C to 125°C) Class B, Fully Compliant
			5962 - 0152203M2X 5962 - 0152203M4X 5962 - 0152203M3X	40D6 44K 44L	Military/883C (-55°C to 125°C) Class B, Fully Compliant

## Ordering Information (Continued)

$t_{PD}$ (ns)	$t_{COS}$ (ns)	Ext. $f_{MAXS}$ (MHz)	Ordering Code	Package	Operation Range
25	12	31	ATF2500CQL-25JC ATF2500CQL-25PC	44J 40P6	Commercial (0°C to 70°C)
			ATF2500CQL-25JI ATF2500CQL-25PI	44J 40P6	Industrial (-40°C to 85°C)
			ATF2500CQL-25GM/883 ATF2500CQL-25KM/883 ATF2500CQL-25NM/883	40D6 44K 44L	Military/883C (-55°C to 125°C) Class B. Fully Compliant
			5962 - 0152204M2X 5962 - 0152204M4X 5962 - 0152204M3X	40D6 44K 44L	Military/883C (-55°C to 125°C) Class B, Fully Compliant

Note: \*SMD numbers are TBD.

## Using “C” Product for Industrial

To use commercial product for Industrial temperature ranges, down-grade one speed grade from the “I” to the “C” device (7 ns “C” = 10 ns “I”) and derate power by 30%.

Package Type	
<b>40D6</b>	40-pin, 0.600" Wide, Ceramic, Dual Inline Package (Cerdip)
<b>44J</b>	44-lead, Plastic J-leaded Chip Carrier OTP (PLCC)
<b>44K</b>	44-lead, Ceramic J-leaded Chip Carrier (JLCC)
<b>40P6</b>	40-pin, 0.600" Wide, Plastic, Dual Inline Package OTP (PDIP)
<b>44L</b>	44-pad, Ceramic Leadless Chip Carrier (LCC)

# Packaging Information

## 40D6 – Cerdip

Dimension in Millimeters and (Inches)  
 Controlling dimension: Inches  
 MIL-STD-1835 D-5 CONFIG A (Glass Sealed)

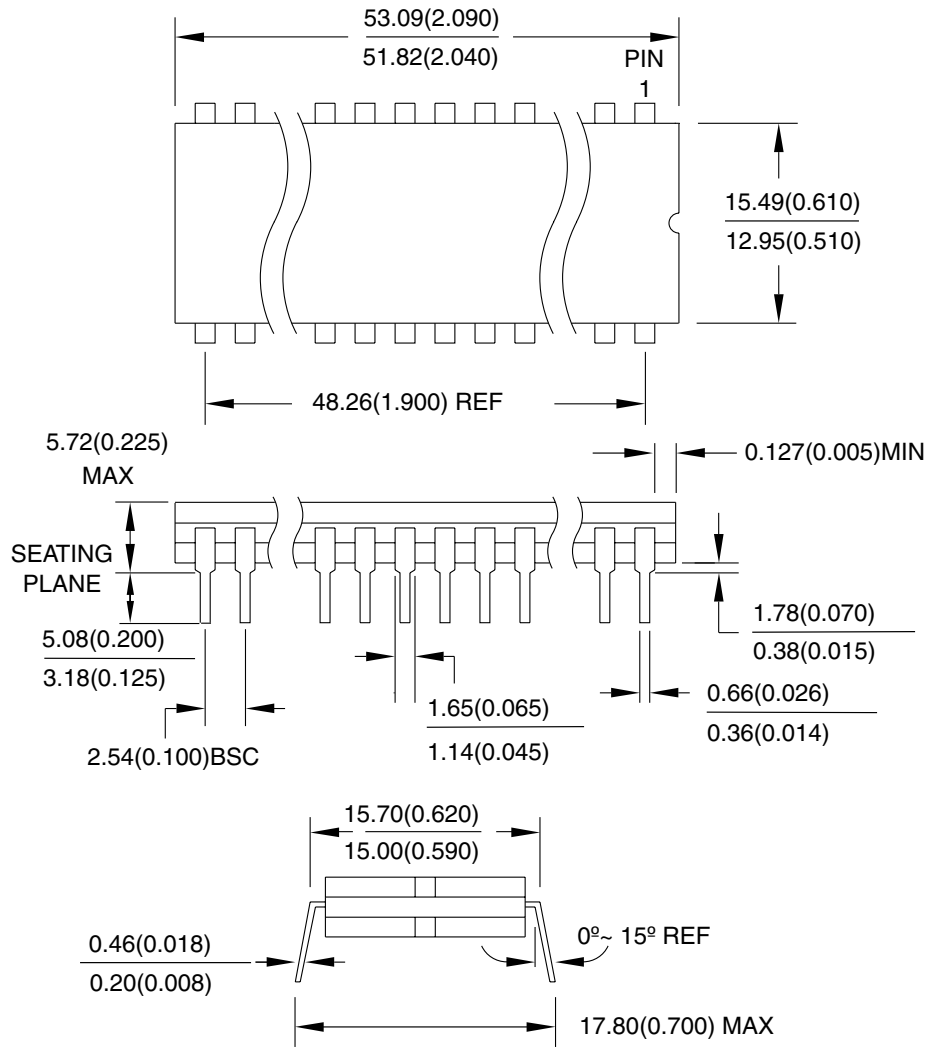

04/11/01



2325 Orchard Parkway  
 San Jose, CA 95131

**TITLE**

**40D6**, 40-lead (0.600" Wide), Non-windowed, Ceramic Dual Inline Package (Cerdip)

**DRAWING NO.**

40D6

**REV.**

A



44J – PLCC

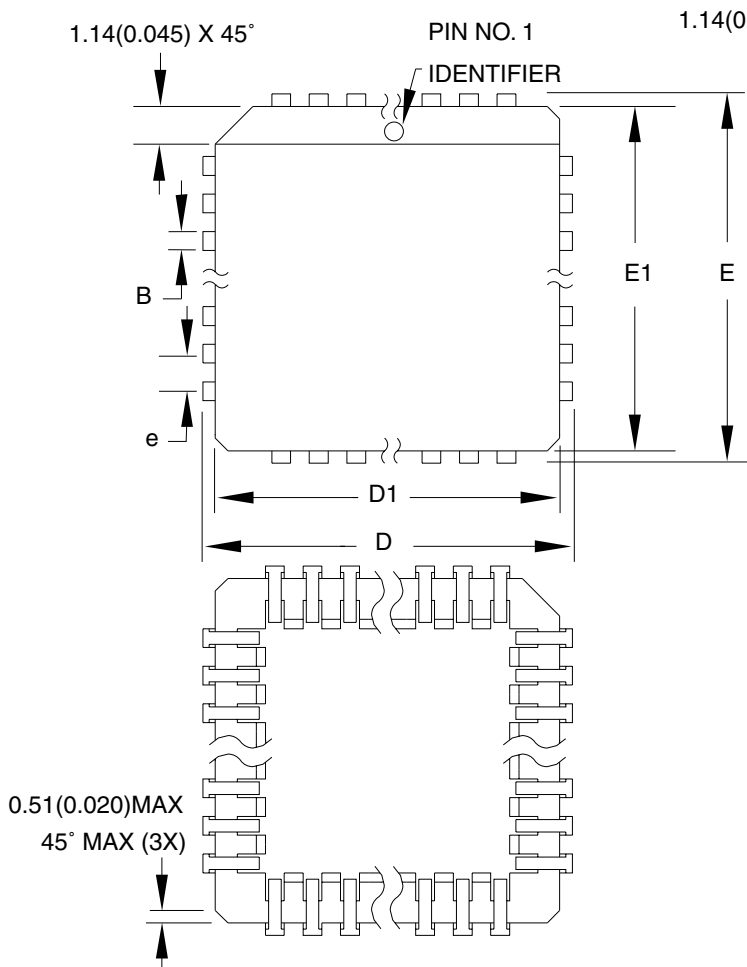

**COMMON DIMENSIONS**  
(Unit of Measure = mm)

SYMBOL	MIN	NOM	MAX	NOTE
A	4.191	–	4.572	
A1	2.286	–	3.048	
A2	0.508	–	–	
D	17.399	–	17.653	
D1	16.510	–	16.662	Note 2
E	17.399	–	17.653	
E1	16.510	–	16.662	Note 2
D2/E2	14.986	–	16.002	
B	0.660	–	0.813	
B1	0.330	–	0.533	
e	1.270 TYP			

- Notes:
1. This package conforms to JEDEC reference MS-018, Variation AC.
  2. Dimensions D1 and E1 do not include mold protrusion. Allowable protrusion is .010"(0.254 mm) per side. Dimension D1 and E1 include mold mismatch and are measured at the extreme material condition at the upper or lower parting line.
  3. Lead coplanarity is 0.004" (0.102 mm) maximum.

10/04/01

**ATMEL** 2325 Orchard Parkway  
San Jose, CA 95131

**TITLE**  
44J, 44-lead, Plastic J-leaded Chip Carrier (PLCC)

**DRAWING NO.** 44J  
**REV.** B

# 44K – JLCC

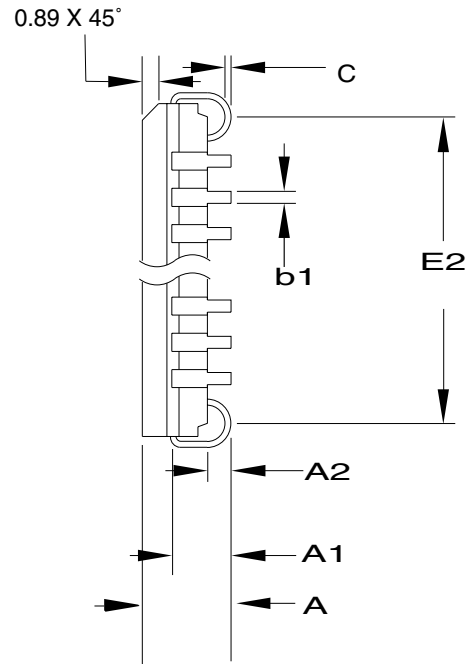
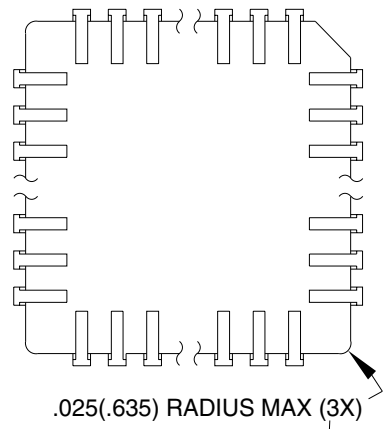
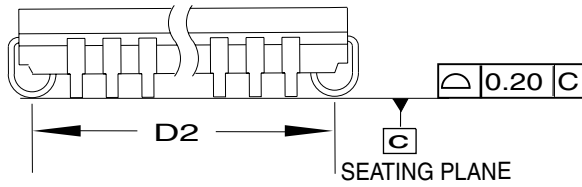
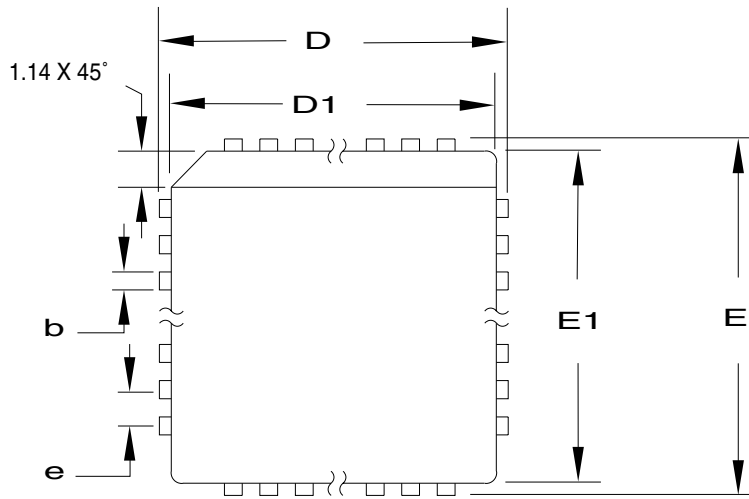

**COMMON DIMENSIONS**  
(Unit of Measure = mm)

SYMBOL	MIN	NOM	MAX	NOTE
A	3.93	4.36	4.57	
A1	2.28	2.66	3.04	
A2	0.89	-	1.14	
D	17.40	17.52	17.65	
D1	16.38	16.63	16.89	
D2	15.00	15.50	16.00	
E	17.40	17.52	17.65	
E1	16.38	16.63	16.89	
E2	15.00	15.50	16.00	
b	0.66	0.73	0.81	
b1	0.43	-	0.58	
c	0.15	-	0.30	
e	1.27 TYP			

Note : Refer to MIL-STD-1835C-J1

09/18/01



2325 Orchard Parkway  
San Jose, CA 95131

**TITLE**

**44K, 44-lead, Non-windowed, Ceramic J-leaded Chip Carrier (JLCC)**

**DRAWING NO.**

44K

**REV.**

A

40P6 – PDIP

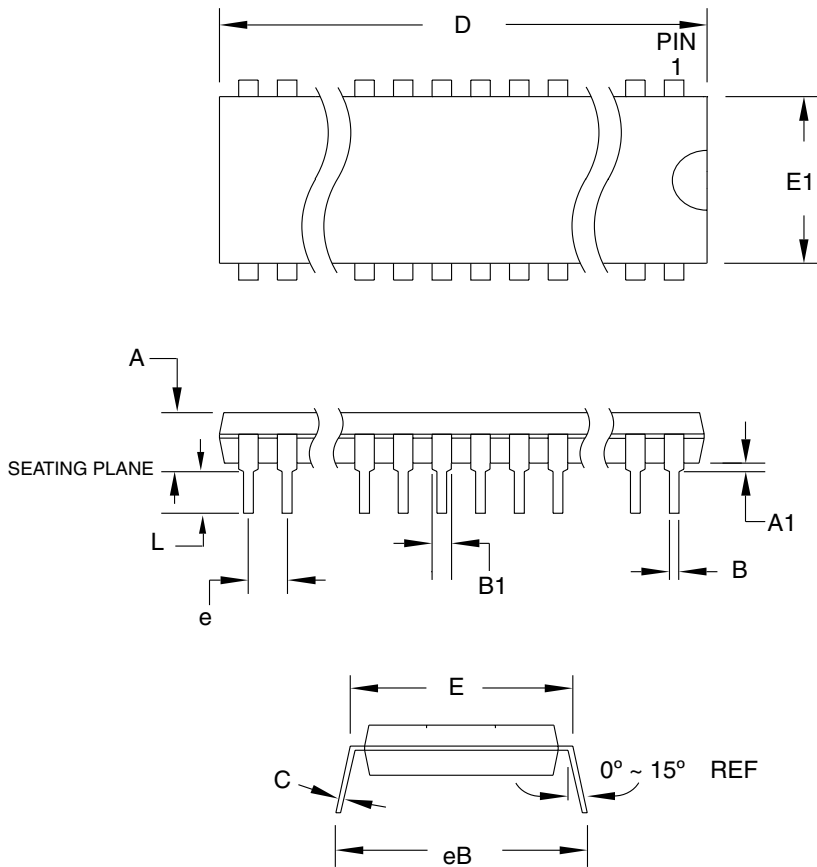

**COMMON DIMENSIONS**  
(Unit of Measure = mm)

SYMBOL	MIN	NOM	MAX	NOTE
A	–	–	4.826	
A1	0.381	–	–	
D	52.070	–	52.578	Note 2
E	15.240	–	15.875	
E1	13.462	–	13.970	Note 2
B	0.356	–	0.559	
B1	1.041	–	1.651	
L	3.048	–	3.556	
C	0.203	–	0.381	
eB	15.494	–	17.526	
e	2.540 TYP			

- Notes:
1. This package conforms to JEDEC reference MS-011, Variation AC.
  2. Dimensions D and E1 do not include mold Flash or Protrusion. Mold Flash or Protrusion shall not exceed 0.25 mm (0.010").

09/28/01



2325 Orchard Parkway  
San Jose, CA 95131

**TITLE**

**40P6**, 40-lead (0.600"/15.24 mm Wide) Plastic Dual  
Inline Package (PDIP)

**DRAWING NO.**

40P6

**REV.**

B







## Atmel Headquarters

### *Corporate Headquarters*

2325 Orchard Parkway  
San Jose, CA 95131  
TEL (408) 441-0311  
FAX (408) 487-2600

### *Europe*

Atmel SarL  
Route des Arsenaux 41  
Casa Postale 80  
CH-1705 Fribourg  
Switzerland  
TEL (41) 26-426-5555  
FAX (41) 26-426-5500

### *Asia*

Atmel Asia, Ltd.  
Room 1219  
Chinachem Golden Plaza  
77 Mody Road Tsimhatsui  
East Kowloon  
Hong Kong  
TEL (852) 2721-9778  
FAX (852) 2722-1369

### *Japan*

Atmel Japan K.K.  
9F, Tonetsu Shinkawa Bldg.  
1-24-8 Shinkawa  
Chuo-ku, Tokyo 104-0033  
Japan  
TEL (81) 3-3523-3551  
FAX (81) 3-3523-7581

## Atmel Operations

### *Memory*

Atmel Corporate  
2325 Orchard Parkway  
San Jose, CA 95131  
TEL (408) 436-4270  
FAX (408) 436-4314

### *Microcontrollers*

Atmel Corporate  
2325 Orchard Parkway  
San Jose, CA 95131  
TEL (408) 436-4270  
FAX (408) 436-4314

Atmel Nantes  
La Chantrerie  
BP 70602  
44306 Nantes Cedex 3, France  
TEL (33) 2-40-18-18-50  
FAX (33) 2-40-28-19-60

### *ASIC/ASSP/Smart Cards*

Atmel Rousset  
Zone Industrielle  
13106 Rousset Cedex, France  
TEL (33) 4-42-53-64-21  
FAX (33) 4-42-53-62-88

Atmel Colorado Springs  
1150 East Cheyenne Mtn. Blvd.  
Colorado Springs, CO 80906  
TEL (719) 576-3300  
FAX (719) 540-1759

Atmel Smart Card ICs  
Scottish Enterprise Technology Park  
Maxwell Building  
East Kilbride G75 0QR, Scotland  
TEL (44) 1355-803-015  
FAX (44) 1355-242-743

### *RF/Automotive*

Atmel Heilbronn  
Theresienstrasse 2  
Postfach 3535  
74025 Heilbronn, Germany  
TEL (49) 71-31-67-0  
FAX (49) 71-31-67-2340

Atmel Colorado Springs  
1150 East Cheyenne Mtn. Blvd.  
Colorado Springs, CO 80906  
TEL (719) 576-3300  
FAX (719) 540-1759

### *Biometrics/Imaging/Hi-Rel MPU/ High Speed Converters/RF Datacom*

Atmel Grenoble  
Avenue de Rochepleine  
BP 123  
38521 Saint-Egreve Cedex, France  
TEL (33) 4-76-58-32-43  
FAX (33) 4-76-58-33-20

---

### *e-mail*

[literature@atmel.com](mailto:literature@atmel.com)

### *Web Site*

<http://www.atmel.com>

### © Atmel Corporation 2001.

Atmel Corporation makes no warranty for the use of its products, other than those expressly contained in the Company's standard warranty which is detailed in Atmel's Terms and Conditions located on the Company's web site. The Company assumes no responsibility for any errors which may appear in this document, reserves the right to change devices or specifications detailed herein at any time without notice, and does not make any commitment to update the information contained herein. No licenses to patents or other intellectual property of Atmel are granted by the Company in connection with the sale of Atmel products, expressly or by implication. Atmel's products are not authorized for use as critical components in life support devices or systems.

ATMEL® is the registered trademark of Atmel.

Other terms and product names may be the trademarks of others.



Printed on recycled paper.

0777G-12/01/0M