



20TQ...  
20TQ...S

SCHOTTKY RECTIFIER

20 Amp

$I_{F(AV)} = 19\text{Amp}$   
 $V_R = 35 \text{ to } 45\text{V}$

**Major Ratings and Characteristics**

Characteristics	20TQ	Units
$I_{F(AV)}$ Rectangular waveform	20	A
$V_{RRM}$ range	35 to 45	V
$I_{FSM}$ @tp = 5 $\mu$ s sine	1800	A
$V_F$ @20 Apk, $T_J = 125^\circ\text{C}$	0.51	V
$T_J$ range	-55 to 150	$^\circ\text{C}$

**Description/ Features**

The 20TQ Schottky rectifier series has been optimized for very low forward voltage drop, with moderate leakage. The proprietary barrier technology allows for reliable operation up to 150° C junction temperature. Typical applications are in switching power supplies, converters, free-wheeling diodes, and reverse battery protection.

- 150° C  $T_J$  operation
- High purity, high temperature epoxy encapsulation for enhanced mechanical strength and moisture resistance
- Low forward voltage drop
- High frequency operation
- Guard ring for enhanced ruggedness and long term reliability

**Case Styles**

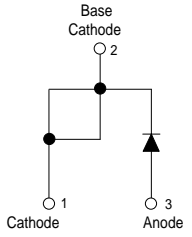
<p>20TQ...</p>  <div style="display: flex; justify-content: center; align-items: center; margin-top: 10px;"> <div style="text-align: center;"> <p>Base Cathode</p> <p>○ 2</p> </div> <div style="margin: 0 10px;"> <p>○ 1</p> <p>Cathode</p> </div> <div style="text-align: center;"> <p>○ 3</p> <p>Anode</p> </div> </div> <p>TO-220AC</p>	<p>20TQ... S</p>  <div style="display: flex; justify-content: center; align-items: center; margin-top: 10px;"> <div style="text-align: center;"> <p>Base Cathode</p> <p>○ 2</p> </div> <div style="margin: 0 10px;"> <p>○ 1</p> <p>N/C</p> </div> <div style="text-align: center;"> <p>○ 3</p> <p>Anode</p> </div> </div> <p>D<sup>2</sup>PAK</p>
--	---

## 20TQ... Series

Bulletin PD-20241 rev. B 12/01

International  
**IR** Rectifier

### Voltage Ratings

Part number	20TQ035	20TQ040	20TQ045
$V_R$ Max. DC Reverse Voltage (V)	35	40	45
$V_{RWM}$ Max. Working Peak Reverse Voltage (V)			

### Absolute Maximum Ratings

Parameters	20TQ	Units	Conditions
$I_{F(AV)}$ Max. Average Forward Current * See Fig. 5	20	A	50% duty cycle @ $T_C = 116^\circ\text{C}$ , rectangular wave form
$I_{FSM}$ Max. Peak One Cycle Non-Repetitive Surge Current * See Fig. 7	1800	A	5 $\mu\text{s}$ Sine or 3 $\mu\text{s}$ Rect. pulse
	400		10ms Sine or 6ms Rect. pulse
$E_{AS}$ Non-Repetitive Avalanche Energy	27	mJ	$T_J = 25^\circ\text{C}$ , $I_{AS} = 4$ Amps, $L = 3.4$ mH
$I_{AR}$ Repetitive Avalanche Current	4	A	Current decaying linearly to zero in 1 $\mu\text{sec}$ Frequency limited by $T_J$ max. $V_A = 1.5 \times V_R$ typical

### Electrical Specifications

Parameters	20TQ	Units	Conditions
$V_{FM}$ Max. Forward Voltage Drop (1) * See Fig. 1	0.57	V	@ 20A
	0.73	V	@ 40A
	0.51	V	@ 20A
	0.67	V	@ 40A
$I_{RM}$ Max. Reverse Leakage Current (1) * See Fig. 2	2.7	mA	$T_J = 25^\circ\text{C}$
	105	mA	$T_J = 125^\circ\text{C}$
$C_T$ Max. Junction Capacitance	1400	pF	$V_R = 5V_{DC}$ , (test signal range 100Khz to 1Mhz) $25^\circ\text{C}$
$L_S$ Typical Series Inductance	8.0	nH	Measured lead to lead 5mm from package body
$dv/dt$ Max. Voltage Rate of Change (Rated $V_R$ )	10000	V/ $\mu\text{s}$	

(1) Pulse Width < 300 $\mu\text{s}$ , Duty Cycle < 2%

### Thermal-Mechanical Specifications

Parameters	20TQ	Units	Conditions
$T_J$ Max. Junction Temperature Range	-55 to 150	$^\circ\text{C}$	
$T_{stg}$ Max. Storage Temperature Range	-55 to 150	$^\circ\text{C}$	
$R_{thJC}$ Max. Thermal Resistance Junction to Case	1.50	$^\circ\text{C/W}$	DC operation * See Fig. 4
$R_{thCS}$ Typical Thermal Resistance, Case to Heatsink	0.50	$^\circ\text{C/W}$	Mounting surface, smooth and greased
wt Approximate Weight	2 (0.07)	g (oz.)	
T Mounting Torque	Min.	6 (5)	Kg-cm (lbf-in)
	Max.	12 (10)	

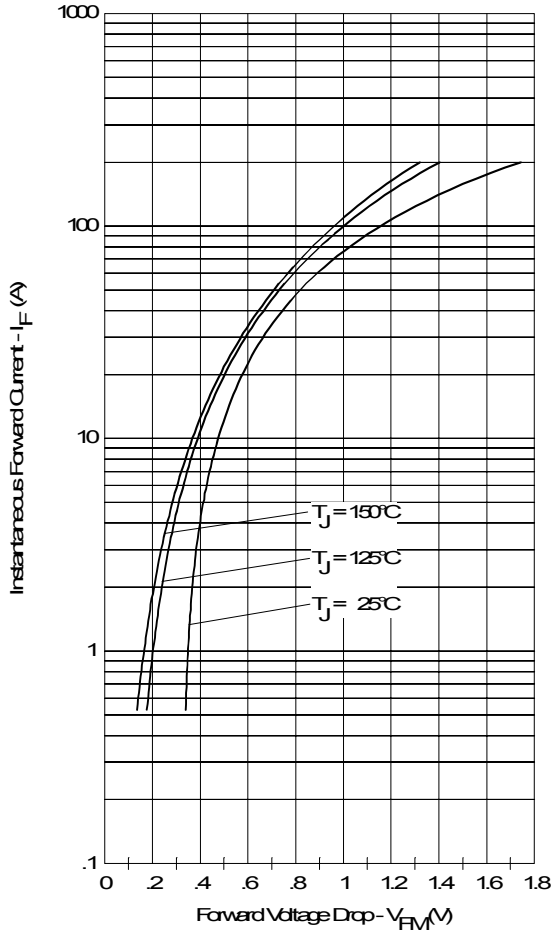

Fig. 1 - Maximum Forward Voltage Drop Characteristics

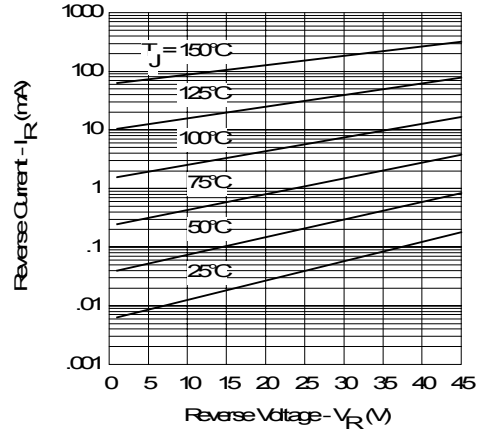

Fig. 2 - Typical Values of Reverse Current Vs. Reverse Voltage

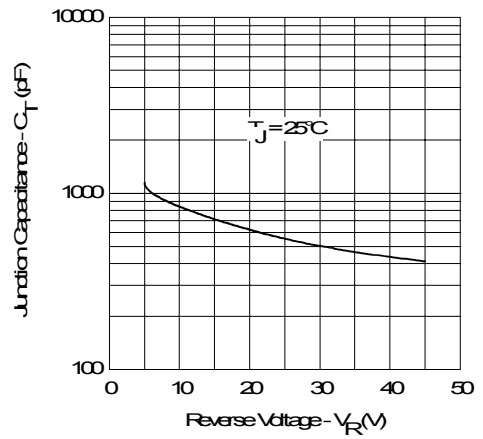

Fig. 3 - Typical Junction Capacitance Vs. Reverse Voltage

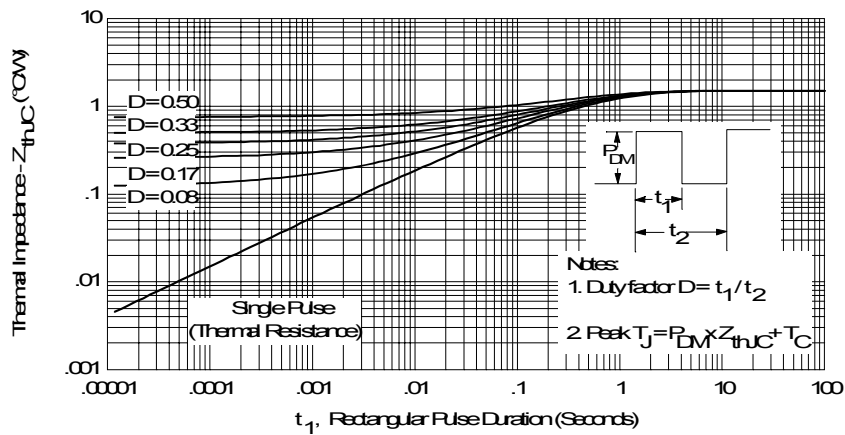

Fig. 4 - Maximum Thermal Impedance  $Z_{thJC}$  Characteristics

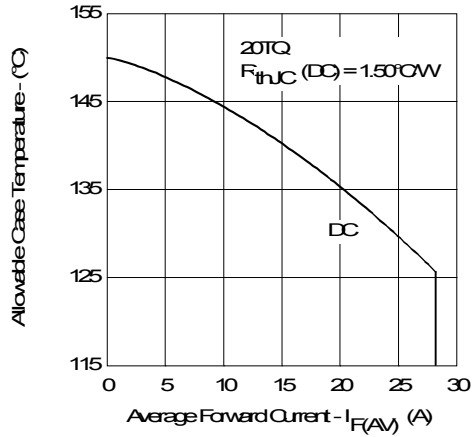

Fig. 5 - Maximum Allowable Case Temperature Vs. Average Forward Current

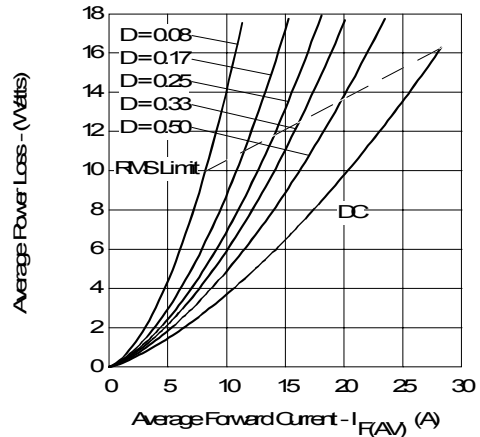

Fig. 6 - Forward Power Loss Characteristics

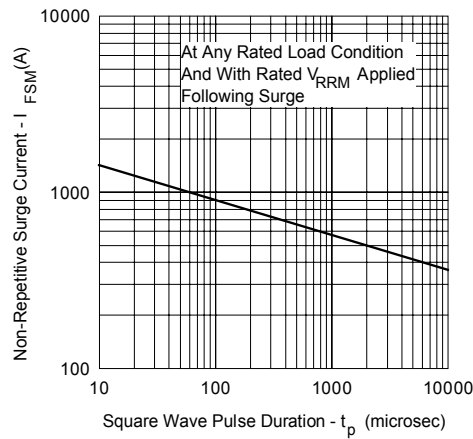

Fig. 7 - Maximum Non-Repetitive Surge Current

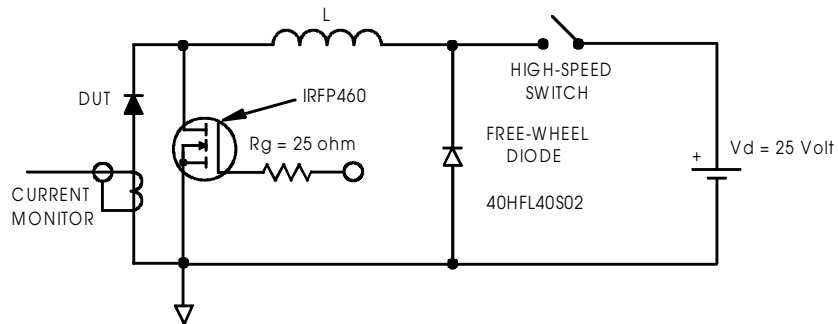
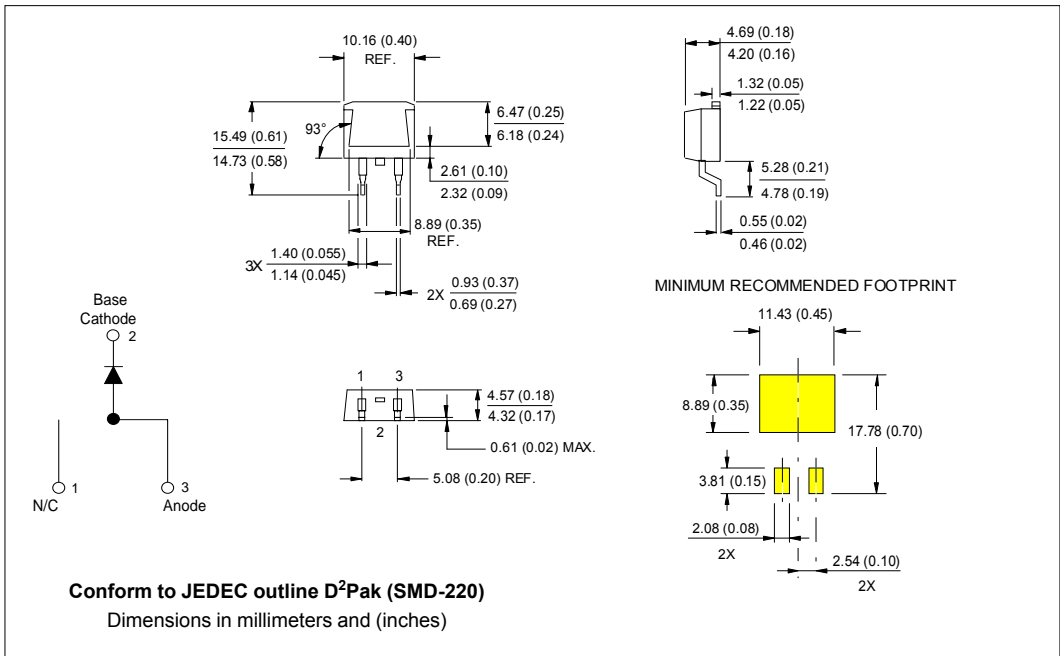
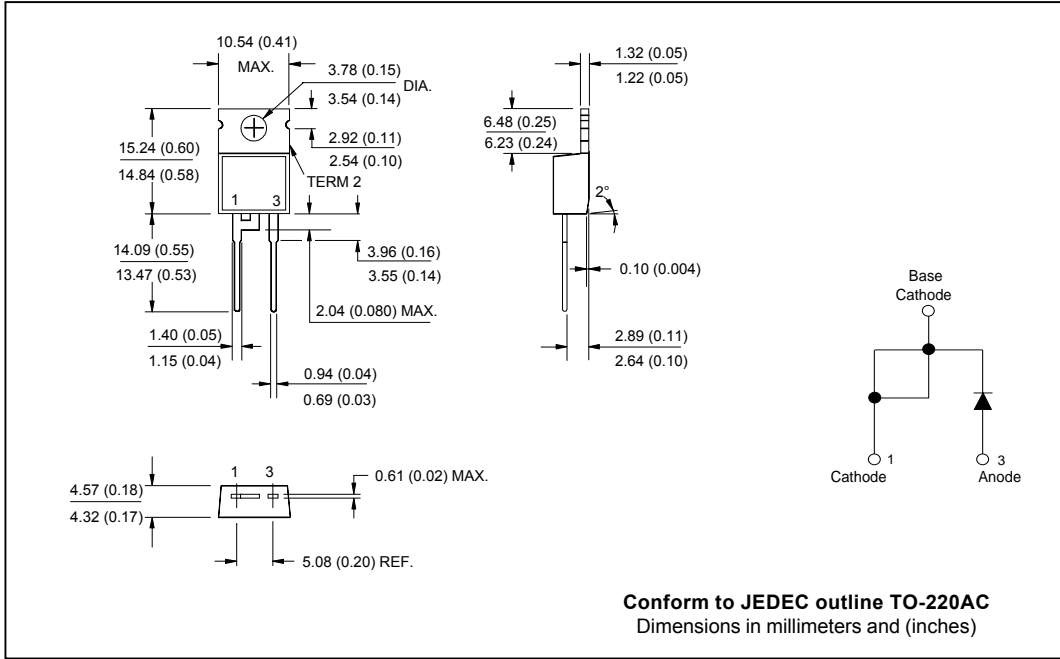
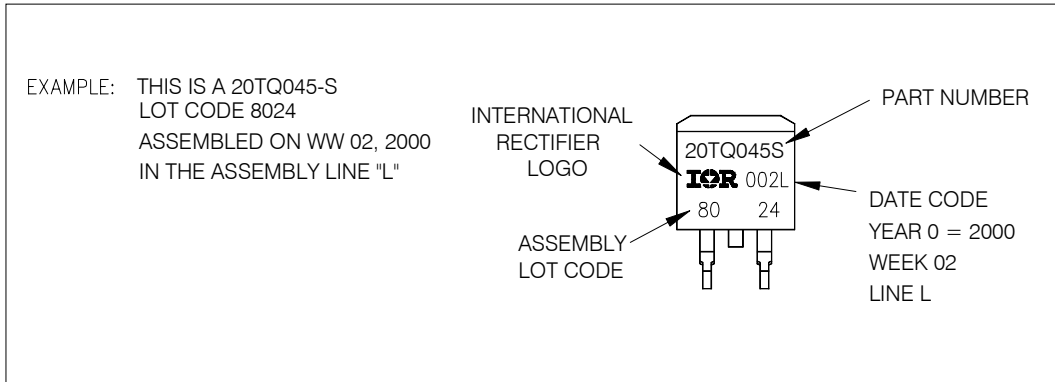

Fig. 8 - Unclamped Inductive Test Circuit

Outline Table



Marking Information



Tape & Reel Information

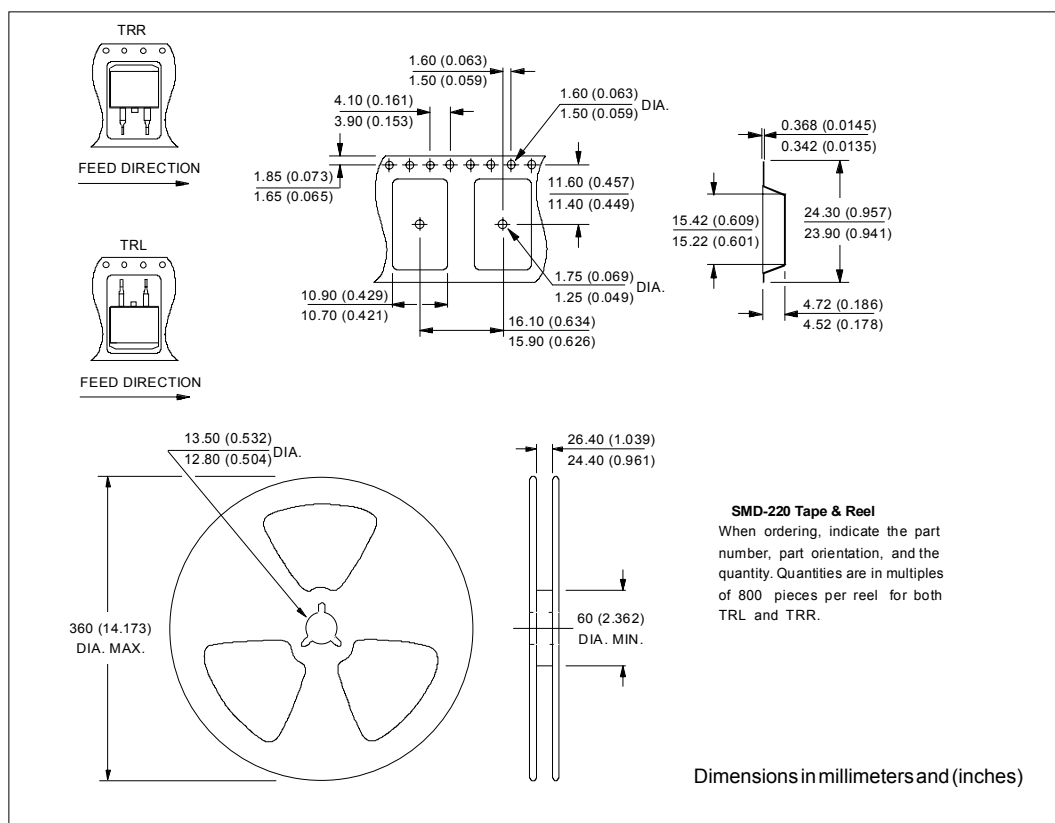

Ordering Information Table

**Device Code**

<b>20</b>	<b>T</b>	<b>Q</b>	<b>045</b>	<b>S</b>
①	②	③	④	⑤

<b>1</b>	- Essential Part Number	
<b>2</b>	- T = TO-220	
<b>3</b>	- Q = Schottky Q Series	
<b>4</b>	- Voltage Rating	035 = 35V
<b>5</b>	- S = D <sup>2</sup> Pak	040 = 40V
		045 = 45V

Data and specifications subject to change without notice.  
 This product has been designed and qualified for Industrial Level.  
 Qualification Standards can be found on IR's Web site.