

# SN75175

## Quad EIA-485 Line Receiver

The Motorola SN75175 is a monolithic quad differential line receiver with three-state outputs. It is designed specifically to meet the requirements of EIA-485, EIA-422A/23A Standards and CCITT recommendations.

The device is optimized for balanced multipoint bus transmission at rates up to 10 megabits per second. It also features high input impedance, input hysteresis for increased noise immunity, and input sensitivity of  $\pm 200$  mV over a common mode input voltage range of  $-12$  V to  $12$  V. The SN75175 is designed for optimum performance when used with the SN75172 or SN75174 quad differential line drivers.

- Meets EIA Standards EIA-422A and EIA-423A, EIA-485
- Meets CCITT Recommendations V.10, V.11, X.26, and X.27
- Designed for Multipoint Transmission on Long Bus Lines in Noisy Environments
- 3-State Outputs
- Common-Mode Input Voltage Range . . .  $-12$  V to  $12$  V
- Input Sensitivity . . .  $\pm 200$  mV
- Input Hysteresis . . . 50 mV Typ
- High Input Impedance . . . 1 EIA-485 Unit Load
- Operates from Single 5.0 V Supply
- Lower Power Requirements
- Plug-In Replacement for MC3486

This device contains 174 active transistors.

### MAXIMUM RATINGS

Rating	Symbol	Value	Unit
Power Supply Voltage	$V_{CC}$	7.0	Vdc
Input Common Mode Voltage	$V_{ICM}$	$\pm 25$	Vdc
Input Differential Voltage	$V_{ID}$	$\pm 25$	Vdc
Three-State Control Input Voltage	$V_I$	7.0	Vdc
Output Sink Current	$I_O$	50	mA
Storage Temperature	$T_{stg}$	$-65$ to $+150$	$^{\circ}C$
Operating Junction Temperature	$T_J$	$+150$	$^{\circ}C$

**NOTE:** ESD data available upon request.

### RECOMMENDED OPERATING CONDITIONS

Rating	Symbol	Value	Unit
Power Supply Voltage	$V_{CC}$	4.75 to 5.25	Vdc
Operating Ambient Temperature	$T_A$	0 to $+70$	$^{\circ}C$
Input Common Mode Voltage Range	$V_{ICM}$	$-12$ to $+12$	Vdc
Input Differential Voltage Range	$V_{IDR}$	$-12$ to $+12$	Vdc

## QUAD EIA-485 LINE RECEIVER WITH THREE-STATE OUTPUTS

### SEMICONDUCTOR TECHNICAL DATA

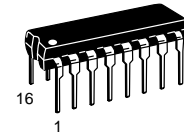

**N SUFFIX**  
PLASTIC PACKAGE  
CASE 648

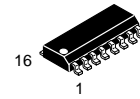

**D SUFFIX**  
PLASTIC PACKAGE  
CASE 751B  
(SO-16)

### PIN CONNECTIONS

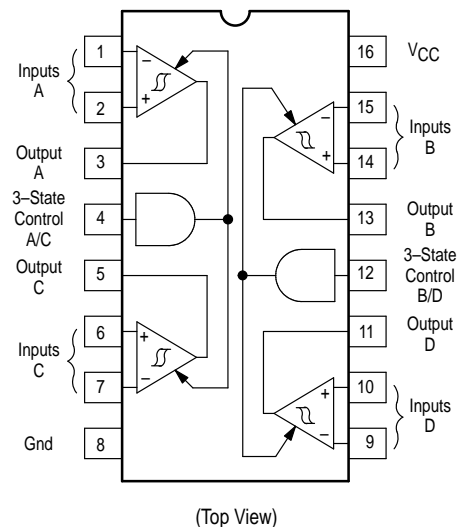

### ORDERING INFORMATION

Device	Operating Temperature Range	Package
SN75175N	$T_A = 0$ to $+70^{\circ}C$	Plastic DIP
SN75175D		SO-16

# SN75175

**ELECTRICAL CHARACTERISTICS** (Unless otherwise noted, minimum and maximum limits apply over recommended temperature and power supply voltage ranges. Typical values are for  $T_A = 25^\circ\text{C}$ ,  $V_{CC} = 5.0\text{ V}$ , and  $V_{ICM} = 0\text{ V}$ , Note 1.)

Characteristic	Symbol	Min	Typ	Max	Unit
Differential Input Threshold Voltage (Note 2) ( $-12\text{ V} \leq V_{ICM} \leq 12\text{ V}$ , $V_{IH} = 2.0\text{ V}$ ) ( $I_O = -0.4\text{ mA}$ , $V_{OH} \geq 2.7\text{ V}$ ) ( $I_O = 16\text{ mA}$ , $V_{OL} \leq 0.5\text{ V}$ )	$V_{TH(D)}$	–	–	0.2 –0.2	V
Input Hysteresis	$V_{T+} - V_{T-}$	–	50	–	mV
Input Line Current (Differential Inputs) (Unmeasured Input at 0 V, Note 3) ( $V_I = 12\text{ V}$ ) ( $V_I = -7.0\text{ V}$ )	$I_I$	–	–	1.0 –0.8	mA
Input Resistance (Note 4)	$r_i$	1 Unit Load	–	–	
Input Balance and Output Level (Note 3) ( $-12\text{ V} \leq V_{ICM} \leq 12\text{ V}$ , $V_{IH} = 2.0\text{ V}$ ) ( $I_O = -0.4\text{ mA}$ , $V_{ID} = 0.2\text{ V}$ ) ( $I_O = 8.0\text{ mA}$ , $V_{ID} = -0.2\text{ V}$ ) ( $I_O = 16\text{ mA}$ , $V_{ID} = -0.2\text{ V}$ )	$V_{OH}$ $V_{OL}$ $V_{OL}$	2.7 – –	– – –	– 0.45 0.5	V
Input Voltage – High Logic State (Three–State Control)	$V_{IH}$	2.0	–	–	V
Input Voltage – Low Logic State (Three–State Control)	$V_{IL}$	–	–	0.8	V
Input Current – High Logic State (Three–State Control) ( $V_{IH} = 2.7\text{ V}$ ) ( $V_{IH} = 5.5\text{ V}$ )	$I_{IH}$	–	–	20 100	$\mu\text{A}$
Input Current – Low Logic State (Three–State Control) ( $V_{IL} = 0.4\text{ V}$ )	$I_{IL}$	–	–	–100	$\mu\text{A}$
Input Clamp Diode Voltage (Three–State Control) ( $I_{IK} = -18\text{ mA}$ )	$V_{IK}$	–	–	–1.5	V
Output Third State Leakage Current ( $V_{I(D)} = 3.0\text{ V}$ , $V_{IL} = 0.8\text{ V}$ , $V_O = 0.4\text{ V}$ ) ( $V_{I(D)} = -3.0\text{ V}$ , $V_{IL} = 0.8\text{ V}$ , $V_O = 2.4\text{ V}$ )	$I_{OZ}$	–	–	–20 20	$\mu\text{A}$
Output Short–Circuit Current (Note 5) ( $V_{I(D)} = 3.0\text{ V}$ , $V_{IH} = 2.0\text{ V}$ , $V_O = 0\text{ V}$ )	$I_{OS}$	–15	–	–85	mA
Power Supply Current ( $V_{IL} = 0\text{ V}$ ) (All Inputs Grounded)	$I_{CC}$	–	–	70	mA

- NOTES:**
1. All currents into device pins are shown as positive, out of device pins are negative. All voltages referenced to ground unless otherwise noted.
  2. Differential input threshold voltage and guaranteed output levels are done simultaneously for worst case.
  3. Refer to EIA–485 for exact conditions. Input balance and guaranteed output levels are done simultaneously for worst case.
  4. Input resistance should be derived from input line current specifications and is shown for reference only. See EIA–485 and input line current specifications for more specific input resistance information.
  5. Only one output at a time should be shorted.

**SWITCHING CHARACTERISTICS** (Unless otherwise noted,  $V_{CC} = 5.0\text{ V}$  and  $T_A = 25^\circ\text{C}$ .)

Characteristic	Symbol	Min	Typ	Max	Unit
Propagation Delay Time – Differential Inputs to Output Output High to Low Output Low to High	$t_{PHL(D)}$ $t_{PLH(D)}$	– –	25 25	35 35	ns
Propagation Delay Time – Three–State Control to Output Output Low to Third State Output High to Third State Output Third State to High Output Third State to Low	$t_{PLZ}$ $t_{PHZ}$ $t_{PZH}$ $t_{PZL}$	– – – –	16 19 11 11	35 35 30 30	ns

# SN75175

## FUNCTION TABLE (EACH RECEIVER)

Differential Inputs	3-State Control	Output Y
$V_{ID} \geq 2.0 \text{ V}$	H	H
$-0.2 \text{ V} < V_{ID} < 0.2 \text{ V}$	H	?
$V_{ID} \leq -0.2 \text{ V}$	H	L
X	L	Z

H = high level  
 L = low level  
 X = irrelevant  
 ? = indeterminate  
 Z = high-impedance (off)

## SWITCHING TEST CIRCUIT AND WAVEFORMS

Figure 1. Propagation Delay, Differential Input to Output

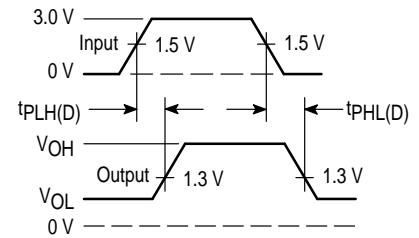
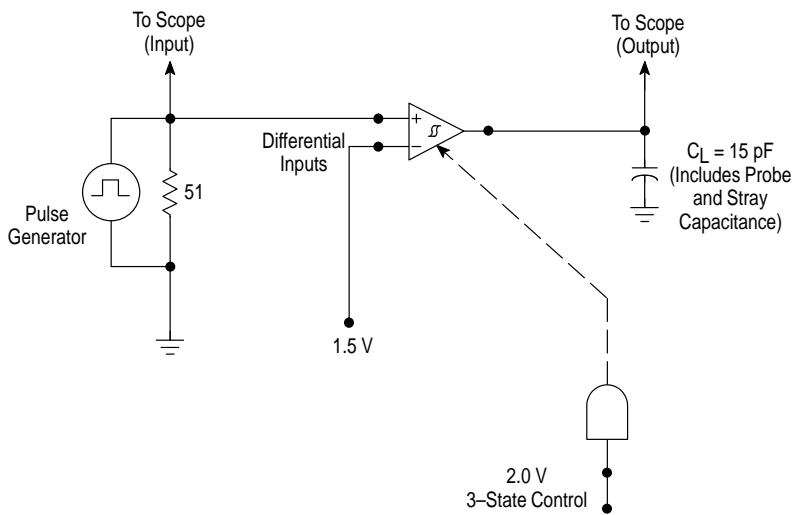

Input Pulse Characteristics –  
 $t_{TLH} = t_{THL} = 6.0 \text{ ns}$  (10% to 90%)  
 PRR = 1.0 MHz, 50% Duty Cycle

# SN75175

## SWITCHING TEST CIRCUIT AND WAVEFORMS (continued)

**Figure 2. Propagation Delay, Three-State Control Input to Output**

Input Pulse Characteristics –  
 $t_{TLH} = t_{THL} = 6.0 \text{ ns}$  (10% to 90%)  
 PRR = 1.0 MHz, 50% Duty Cycle

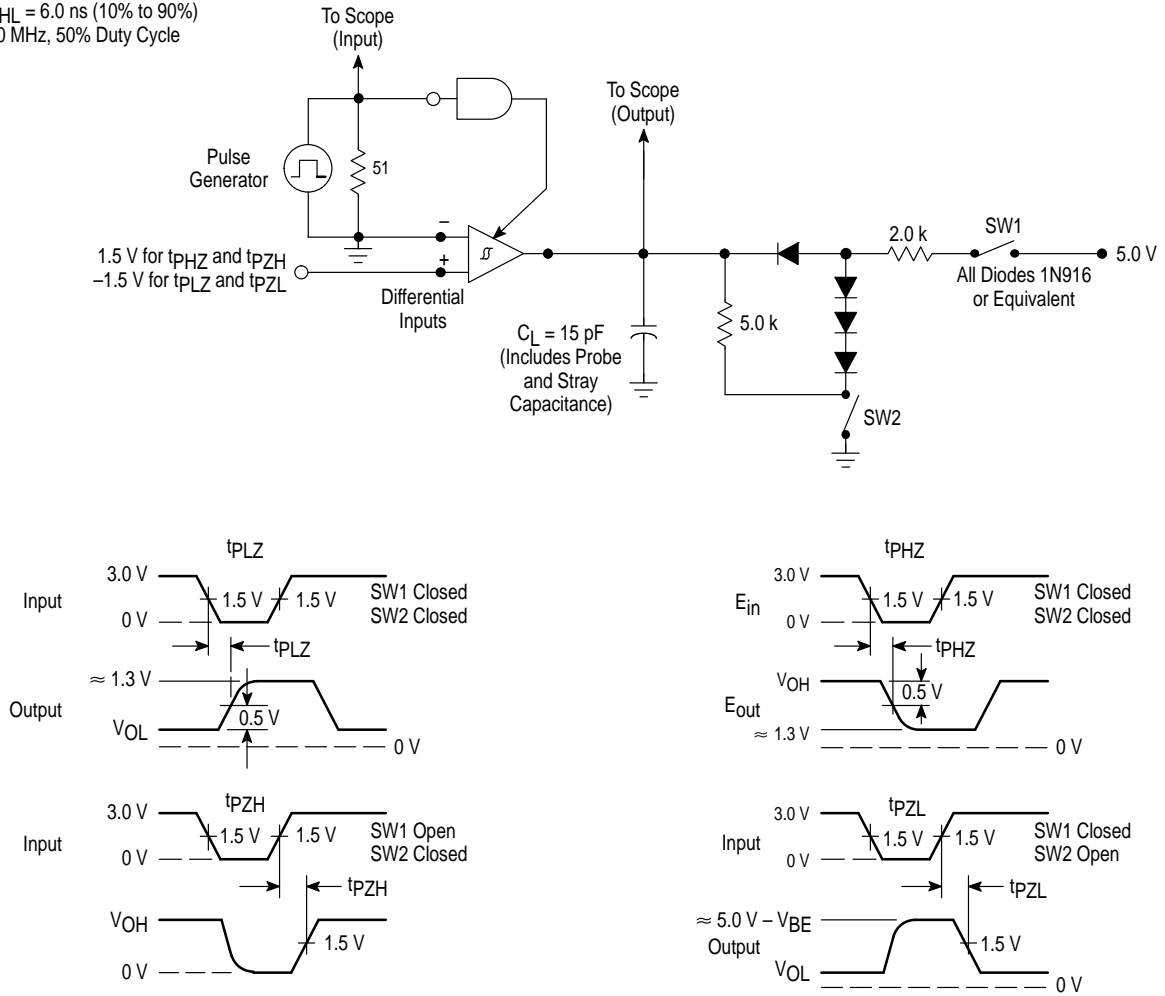

TYPICAL CHARACTERISTICS

Figure 3. Output Voltage versus Differential Input Voltage

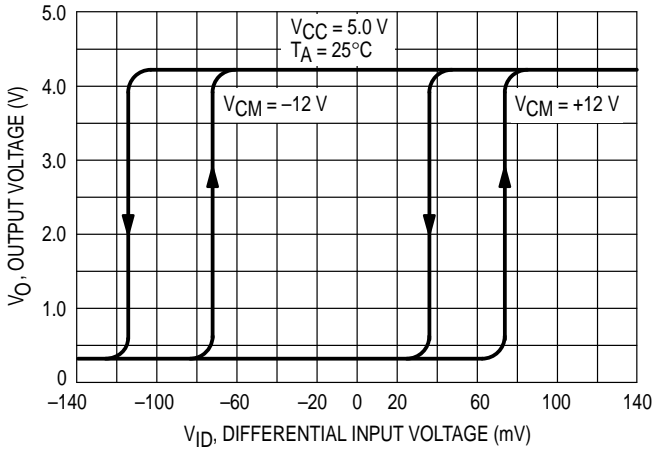

Figure 4. Output Voltage versus 3-State Control Voltage

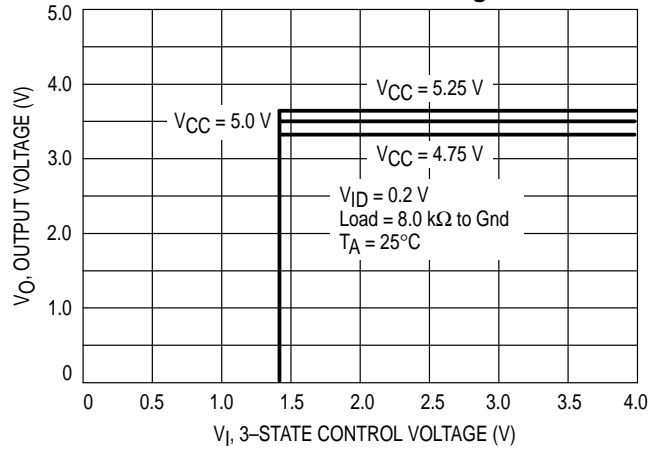

Figure 5. High Level Output Voltage versus Output Current

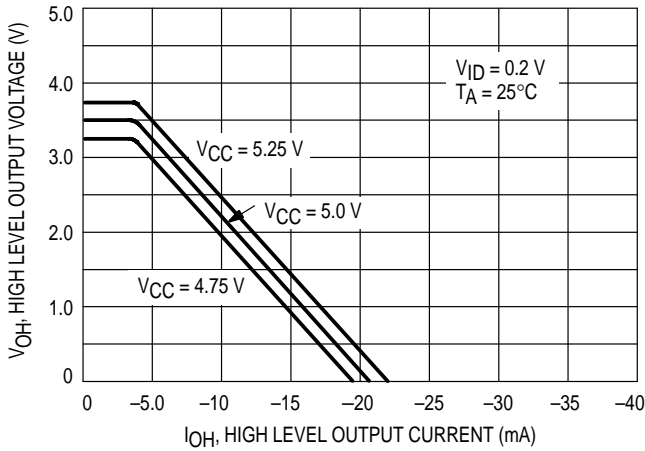

Figure 6. Low Level Output Voltage versus Output Current

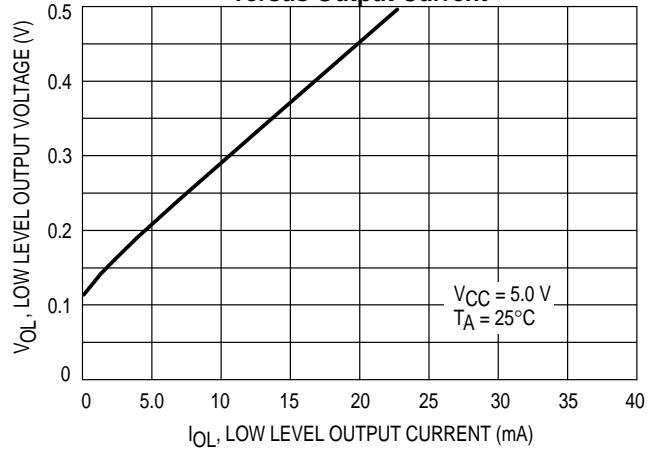

Figure 7. High Level Output Voltage versus Temperature

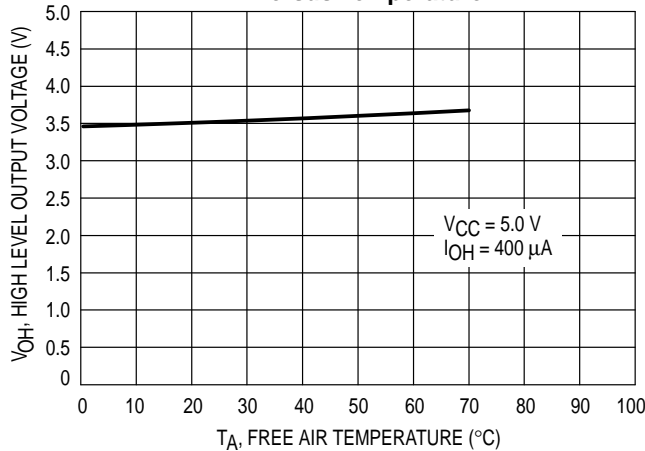
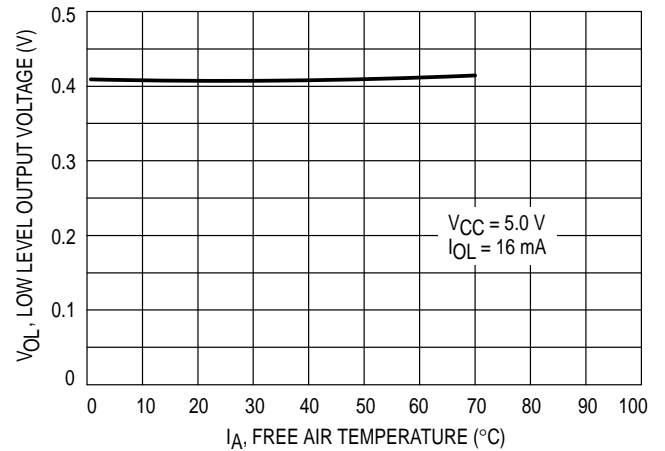

Figure 8. Low Level Output Voltage versus Temperature



# SN75175

## OUTLINE DIMENSIONS

### N SUFFIX PLASTIC PACKAGE CASE 648-08 ISSUE R

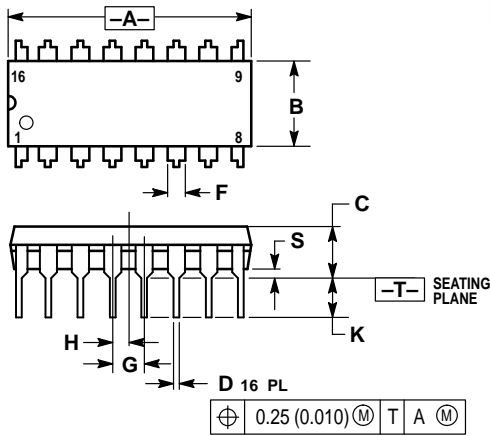

NOTES:

1. DIMENSIONING AND TOLERANCING PER ANSI Y14.5M, 1982.
2. CONTROLLING DIMENSION: INCH.
3. DIMENSION L TO CENTER OF LEADS WHEN FORMED PARALLEL.
4. DIMENSION B DOES NOT INCLUDE MOLD FLASH.
5. ROUNDED CORNERS OPTIONAL.

DIM	INCHES		MILLIMETERS	
	MIN	MAX	MIN	MAX
A	0.740	0.770	18.80	19.55
B	0.250	0.270	6.35	6.85
C	0.145	0.175	3.69	4.44
D	0.015	0.021	0.39	0.53
F	0.040	0.70	1.02	1.77
G	0.100 BSC		2.54 BSC	
H	0.050 BSC		1.27 BSC	
J	0.008	0.015	0.21	0.38
K	0.110	0.130	2.80	3.30
L	0.295	0.305	7.50	7.74
M	0°	10°	0°	10°
S	0.020	0.040	0.51	1.01

### D SUFFIX PLASTIC PACKAGE CASE 751B-05 (SO-16) ISSUE J

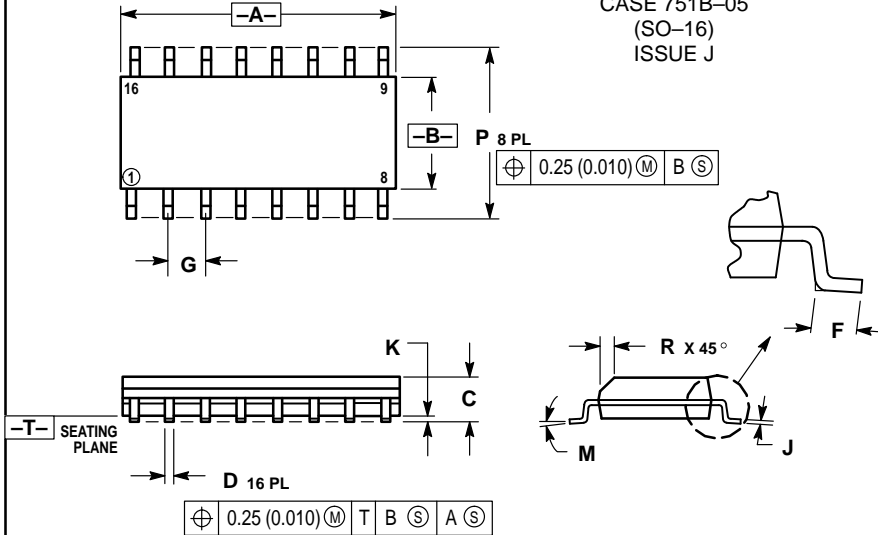

NOTES:

1. DIMENSIONING AND TOLERANCING PER ANSI Y14.5M, 1982.
2. CONTROLLING DIMENSION: MILLIMETER.
3. DIMENSIONS A AND B DO NOT INCLUDE MOLD PROTRUSION.
4. MAXIMUM MOLD PROTRUSION 0.15 (0.006) PER SIDE.
5. DIMENSION D DOES NOT INCLUDE DAMBAR PROTRUSION. ALLOWABLE DAMBAR PROTRUSION SHALL BE 0.127 (0.005) TOTAL IN EXCESS OF THE D DIMENSION AT MAXIMUM MATERIAL CONDITION.

DIM	MILLIMETERS		INCHES	
	MIN	MAX	MIN	MAX
A	9.80	10.00	0.386	0.393
B	3.80	4.00	0.150	0.157
C	1.35	1.75	0.054	0.068
D	0.35	0.49	0.014	0.019
F	0.40	1.25	0.016	0.049
G	1.27 BSC		0.050 BSC	
J	0.19	0.25	0.008	0.009
K	0.10	0.25	0.004	0.009
M	0°	7°	0°	7°
P	5.80	6.20	0.229	0.244
R	0.25	0.50	0.010	0.019

Motorola reserves the right to make changes without further notice to any products herein. Motorola makes no warranty, representation or guarantee regarding the suitability of its products for any particular purpose, nor does Motorola assume any liability arising out of the application or use of any product or circuit, and specifically disclaims any and all liability, including without limitation consequential or incidental damages. "Typical" parameters which may be provided in Motorola data sheets and/or specifications can and do vary in different applications and actual performance may vary over time. All operating parameters, including "Typicals" must be validated for each customer application by customer's technical experts. Motorola does not convey any license under its patent rights nor the rights of others. Motorola products are not designed, intended, or authorized for use as components in systems intended for surgical implant into the body, or other applications intended to support or sustain life, or for any other application in which the failure of the Motorola product could create a situation where personal injury or death may occur. Should Buyer purchase or use Motorola products for any such unintended or unauthorized application, Buyer shall indemnify and hold Motorola and its officers, employees, subsidiaries, affiliates, and distributors harmless against all claims, costs, damages, and expenses, and reasonable attorney fees arising out of, directly or indirectly, any claim of personal injury or death associated with such unintended or unauthorized use, even if such claim alleges that Motorola was negligent regarding the design or manufacture of the part. Motorola and  are registered trademarks of Motorola, Inc. Motorola, Inc. is an Equal Opportunity/Affirmative Action Employer.

# SN75175

**How to reach us:**

**USA/EUROPE/Locations Not Listed:** Motorola Literature Distribution;  
P.O. Box 20912; Phoenix, Arizona 85036. 1-800-441-2447 or 602-303-5454

**MFAX:** RMFAX0@email.sps.mot.com – TOUCHTONE 602-244-6609  
**INTERNET:** <http://Design-NET.com>

**JAPAN:** Nippon Motorola Ltd.; Tatsumi-SPD-JLDC, 6F Seibu-Butsuryu-Center,  
3-14-2 Tatsumi Koto-Ku, Tokyo 135, Japan. 03-81-3521-8315

**ASIA/PACIFIC:** Motorola Semiconductors H.K. Ltd.; 8B Tai Ping Industrial Park,  
51 Ting Kok Road, Tai Po, N.T., Hong Kong. 852-26629298



**MOTOROLA**



SN75175/D

