



# Very Low Power/Voltage CMOS SRAM 1M X 8 bit

## BS62LV8006

### FEATURES

- Vcc operation voltage : 4.5V ~ 5.5V
- Very low power consumption :  
 Vcc = 5.0V C-grade: 75mA (@55ns) operating current  
 I-grade: 76mA (@55ns) operating current  
 C-grade: 60mA (@70ns) operating current  
 I-grade: 61mA (@70ns) operating current  
 8.0uA (Typ.) CMOS standby current
- High speed access time :  
 -55 55ns  
 -70 70ns
- Automatic power down when chip is deselected
- Three state outputs and TTL compatible
- Fully static operation
- Data retention supply voltage as low as 1.5V
- Easy expansion with CE1, CE2 and OE options

### GENERAL DESCRIPTION

The BS62LV8006 is a high performance, very low power CMOS Static Random Access Memory organized as 1,048,576 words by 8 bits and operates from a range of 4.5V to 5.5V supply voltage. Advanced CMOS technology and circuit techniques provide both high speed and low power features with a typical CMOS standby current of 8.0uA at 5V/25°C and maximum access time of 55ns at 5.0V/85°C. Easy memory expansion is provided by an active LOW chip enable ( $\overline{CE1}$ ), an active HIGH chip enable (CE2) and active LOW output enable ( $\overline{OE}$ ) and three-state output drivers. The BS62LV8006 has an automatic power down feature, reducing the power consumption significantly when chip is deselected. The BS62LV8006 is available in 48B BGA and 44L TSOP2 packages.

### PRODUCT FAMILY

PRODUCT FAMILY	OPERATING TEMPERATURE	Vcc RANGE	SPEED ( ns )	POWER DISSIPATION		PKG TYPE
				STANDBY ( IccSB1, Max )	Operating ( Icc, Max )	
				Vcc=5V	Vcc=5V 55ns	
BS62LV8006EC	+0°C to +70°C	4.5V ~ 5.5V	55ns : 4.5~5.5V 70ns : 4.5~5.5V	55uA	75mA	TSOP2-44 BGA-48-0912
BS62LV8006FC						
BS62LV8006EI	-40°C to +85°C	4.5V ~ 5.5V	55 / 70	110uA	76mA	TSOP2-44 BGA-48-0912
BS62LV8006FI						

### PIN CONFIGURATIONS

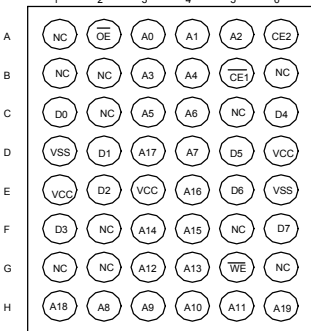
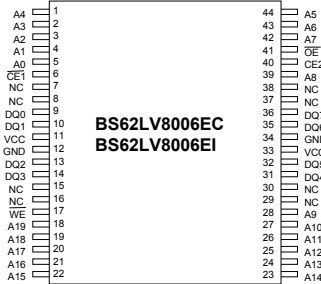

48-ball BGA top view

### FUNCTIONAL BLOCK DIAGRAM

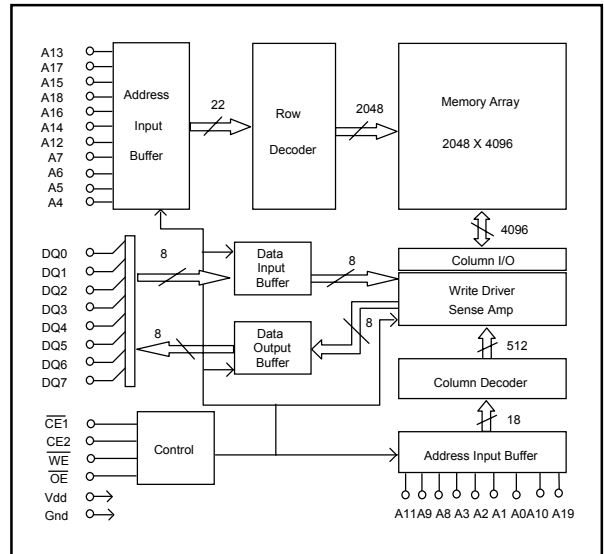

Brilliance Semiconductor, Inc. reserves the right to modify document contents without notice.

**■ PIN DESCRIPTIONS**

Name	Function
<b>A0-A19 Address Input</b>	These 20 address inputs select one of the 1,048,576 x 8-bit words in the RAM
<b><math>\overline{CE1}</math> Chip Enable 1 Input CE2 Chip Enable 2 Input</b>	$\overline{CE1}$ is active LOW and CE2 is active HIGH. Both chip enables must be active when data read from or write to the device. If either chip enable is not active, the device is deselected and is in a standby power mode. The DQ pins will be in the high impedance state when the device is deselected.
<b><math>\overline{WE}</math> Write Enable Input</b>	The write enable input is active LOW and controls read and write operations. With the chip selected, when $\overline{WE}$ is HIGH and $\overline{OE}$ is LOW, output data will be present on the DQ pins; when $\overline{WE}$ is LOW, the data present on the DQ pins will be written into the selected memory location.
<b><math>\overline{OE}</math> Output Enable Input</b>	The output enable input is active LOW. If the output enable is active while the chip is selected and the write enable is inactive, data will be present on the DQ pins and they will be enabled. The DQ pins will be in the high impedance state when $\overline{OE}$ is inactive.
<b>DQ0-DQ7 Data Input/Output Ports</b>	These 8 bi-directional ports are used to read data from or write data into the RAM.
<b>Vcc</b>	Power Supply
<b>Gnd</b>	Ground

**■ TRUTH TABLE**

MODE	$\overline{WE}$	$\overline{CE1}$	CE2	$\overline{OE}$	I/O OPERATION	Vcc CURRENT
Not selected (Power Down)	X	H	X	X	High Z	$I_{CCSB}, I_{CCSB1}$
	X	X	L	X		
Output Disabled	H	L	H	H	High Z	$I_{CC}$
Read	H	L	H	L	DOUT	$I_{CC}$
Write	L	L	H	X	DIN	$I_{CC}$

**■ ABSOLUTE MAXIMUM RATINGS<sup>(1)</sup>**

SYMBOL	PARAMETER	RATING	UNITS
V TERM	Terminal Voltage with Respect to GND	-0.5 to Vcc+0.5	V
T BIAS	Temperature Under Bias	-40 to +85	°C
T STG	Storage Temperature	-60 to +150	°C
P T	Power Dissipation	1.0	W
I OUT	DC Output Current	20	mA

1. Stresses greater than those listed under ABSOLUTE MAXIMUM RATINGS may cause permanent damage to the device. This is a stress rating only and functional operation of the device at these or any other conditions above those indicated in the operational sections of this specification is not implied. Exposure to absolute maximum rating conditions for extended periods may affect reliability.

**■ OPERATING RANGE**

RANGE	AMBIENT TEMPERATURE	Vcc
Commercial	0 °C to +70 °C	4.5V ~ 5.5V
Industrial	-40 °C to +85 °C	4.5V ~ 5.5V

**■ CAPACITANCE <sup>(1)</sup> (TA = 25°C, f = 1.0 MHz)**

SYMBOL	PARAMETER	CONDITIONS	MAX.	UNIT
CIN	Input Capacitance	VIN=0V	10	pF
CDQ	Input/Output Capacitance	V <sub>I/O</sub> =0V	12	pF

1. This parameter is guaranteed and not 100% tested.

**DC ELECTRICAL CHARACTERISTICS ( TA = -40°C to + 85°C )**

PARAMETER NAME	PARAMETER	TEST CONDITIONS	MIN.	TYP. <sup>(1)</sup>	MAX.	UNITS
V <sub>IL</sub>	Guaranteed Input Low Voltage <sup>(3)</sup>	V <sub>CC</sub> =5V	-0.5	--	0.8	V
V <sub>IH</sub>	Guaranteed Input High Voltage <sup>(3)</sup>	V <sub>CC</sub> =5V	2.2	--	V <sub>CC</sub> +0.3	V
I <sub>IL</sub>	Input Leakage Current	V <sub>CC</sub> = Max, V <sub>IN</sub> = 0V to V <sub>CC</sub>	--	--	1	uA
I <sub>LO</sub>	Output Leakage Current	V <sub>CC</sub> = Max, $\overline{CE1} = V_{IH}$ or CE2 = V <sub>IL</sub> or $\overline{OE} = V_{IH}$ , V <sub>IO</sub> = 0V to V <sub>CC</sub>	--	--	1	uA
V <sub>OL</sub>	Output Low Voltage	V <sub>CC</sub> = Max, I <sub>OL</sub> = 2mA	--	--	0.4	V
V <sub>OH</sub>	Output High Voltage	V <sub>CC</sub> = Min, I <sub>OH</sub> = -1mA	2.4	--	--	V
I <sub>CC</sub> <sup>(4)</sup>	Operating Power Supply Current	$\overline{CE1} = V_{IL}$ , CE2 = V <sub>IH</sub> , I <sub>DQ</sub> = 0mA, F = F <sub>max</sub> <sup>(2)</sup>				
		55ns	--	--	76	mA
		70ns	--	--	61	
I <sub>CCSB</sub>	Standby Current-TTL	$\overline{CE1} = V_{IH}$ or CE2 = V <sub>IL</sub> , I <sub>DQ</sub> = 0mA	--	--	2	mA
I <sub>CCSB1</sub> <sup>(5)</sup>	Standby Current-CMOS	$\overline{CE1} \geq V_{CC} - 0.2V$ or CE2 $\leq 0.2V$ V <sub>IN</sub> $\geq V_{CC} - 0.2V$ or V <sub>IN</sub> $\leq 0.2V$	--	8	110	uA

1. Typical characteristics are at TA = 25°C.
2. F<sub>max</sub> = 1/t<sub>RC</sub>.
3. These are absolute values with respect to device ground and all overshoots due to system or tester noise are included.
4. I<sub>CC Max</sub> is 75mA@55ns/0~70°C. ; I<sub>CC Max</sub> is 60mA@70ns/0~70°C.
5. I<sub>CCSB1</sub> is 55uA at V<sub>CC</sub>=5.0V and TA=70°C.

**DATA RETENTION CHARACTERISTICS ( TA = -40 to + 85°C )**

SYMBOL	PARAMETER	TEST CONDITIONS	MIN.	TYP. <sup>(1)</sup>	MAX.	UNITS
V <sub>DR</sub>	V <sub>CC</sub> for Data Retention	$\overline{CE1} \geq V_{CC} - 0.2V$ or CE2 $\leq 0.2V$ , V <sub>IN</sub> $\geq V_{CC} - 0.2V$ or V <sub>IN</sub> $\leq 0.2V$	1.5	--	--	V
I <sub>CCDR</sub> <sup>(3)</sup>	Data Retention Current	$\overline{CE1} \geq V_{CC} - 0.2V$ or CE2 $\leq 0.2V$ , V <sub>IN</sub> $\geq V_{CC} - 0.2V$ or V <sub>IN</sub> $\leq 0.2V$	--	0.8	2.5	uA
t <sub>CDR</sub>	Chip Deselect to Data Retention Time	See Retention Waveform	0	--	--	ns
t <sub>R</sub>	Operation Recovery Time		T <sub>RC</sub> <sup>(2)</sup>	--	--	ns

1. V<sub>CC</sub> = 1.5V, T<sub>A</sub> = + 25°C
2. t<sub>RC</sub> = Read Cycle Time
3. I<sub>CCDR</sub>(Max.) is 1.3uA at TA=70°C.

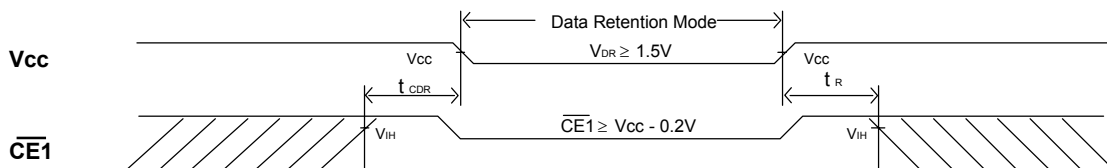
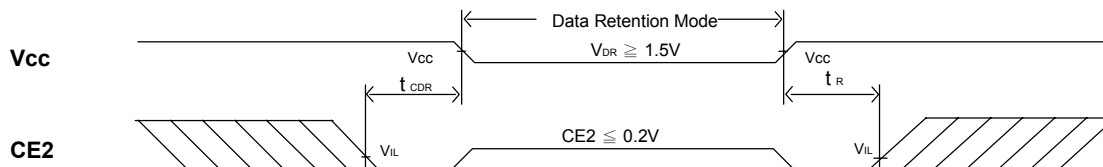



**LOW V<sub>CC</sub> DATA RETENTION WAVEFORM (1) (  $\overline{CE1}$  Controlled )**

**LOW V<sub>CC</sub> DATA RETENTION WAVEFORM (2) ( CE2 Controlled )**

**■ AC TEST CONDITIONS**

(Test Load and Input/Output Reference)

Input Pulse Levels	Vcc / 0V
Input Rise and Fall Times	1V/ns
Input and Output Timing Reference Level	0.5Vcc
Output Load	C <sub>L</sub> = 30pF+1TTL C <sub>L</sub> = 100pF+1TTL

**■ KEY TO SWITCHING WAVEFORMS**

WAVEFORM	INPUTS	OUTPUTS
	MUST BE STEADY	MUST BE STEADY
	MAY CHANGE FROM H TO L	WILL BE CHANGE FROM H TO L
	MAY CHANGE FROM L TO H	WILL BE CHANGE FROM L TO H
	DON'T CARE: ANY CHANGE PERMITTED	CHANGE : STATE UNKNOWN
	DOES NOT APPLY	CENTER LINE IS HIGH IMPEDANCE "OFF" STATE

**■ AC ELECTRICAL CHARACTERISTICS ( TA = -40°C to + 85°C )**
**READ CYCLE**

JEDEC PARAMETER NAME	PARAMETER NAME	DESCRIPTION	CYCLE TIME : 70ns V <sub>CC</sub> =4.5-5.5V			CYCLE TIME : 55ns V <sub>CC</sub> =4.5-5.5V			UNIT
			MIN.	TYP.	MAX.	MIN.	TYP.	MAX.	
t <sub>AVAX</sub>	t <sub>RC</sub>	Read Cycle Time	70	--	--	55	--	--	ns
t <sub>AVQV</sub>	t <sub>AA</sub>	Address Access Time	--	--	70	--	--	55	ns
t <sub>E1LQV</sub>	t <sub>ACS1</sub>	Chip Select Access Time (CE1)	--	--	70	--	--	55	ns
t <sub>E2LQV</sub>	t <sub>ACS2</sub>	Chip Select Access Time (CE2)	--	--	70	--	--	55	ns
t <sub>GLQV</sub>	t <sub>OE</sub>	Output Enable to Output Valid	--	--	35	--	--	30	ns
t <sub>ELQX</sub>	t <sub>CLZ</sub>	Chip Select to Output Low Z	10	--	--	10	--	--	ns
t <sub>GLQX</sub>	t <sub>OLZ</sub>	Output Enable to Output in Low Z	10	--	--	10	--	--	ns
t <sub>EHQZ</sub>	t <sub>CHZ</sub>	Chip Deselect to Output in High Z	--	--	35	--	--	30	ns
t <sub>GHQZ</sub>	t <sub>OHZ</sub>	Output Disable to Output in High Z	--	--	30	--	--	25	ns
t <sub>AXOX</sub>	t <sub>OH</sub>	Data Hold from Address Change	10	--	--	10	--	--	ns

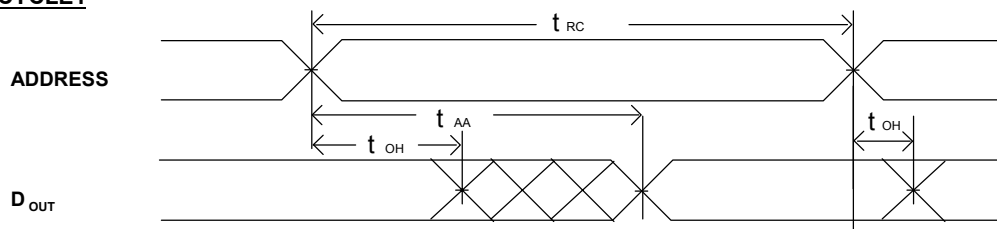
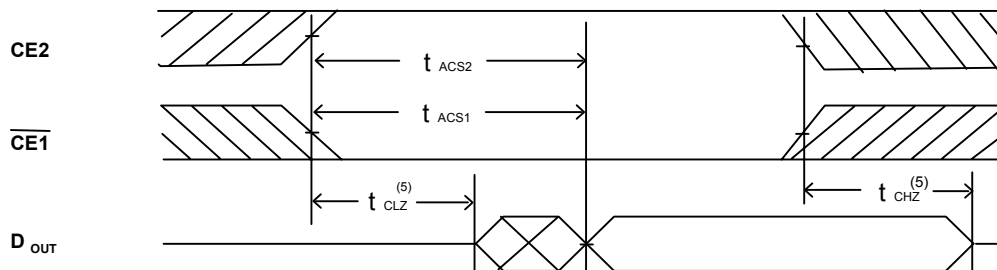
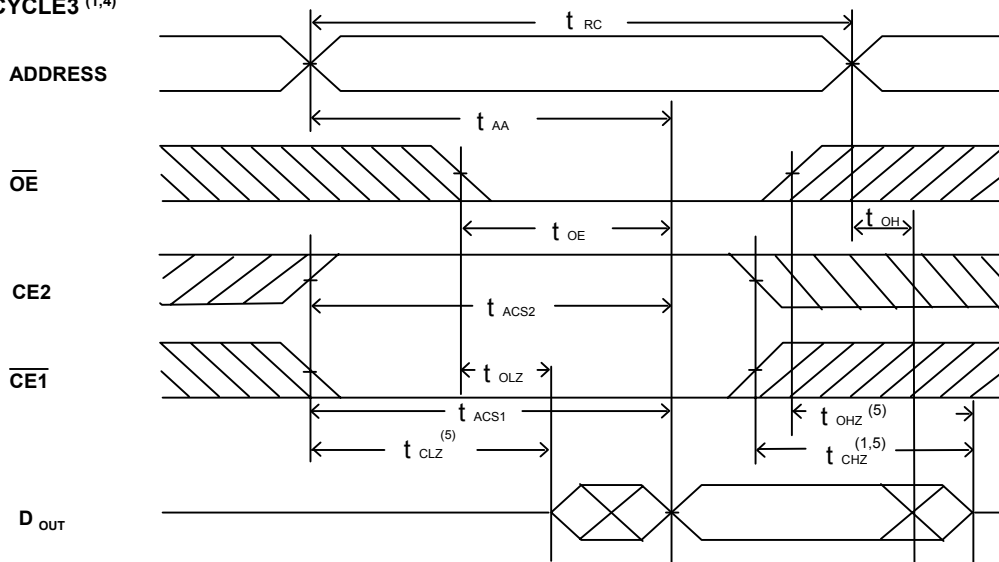
**SWITCHING WAVEFORMS (READ CYCLE)**
**READ CYCLE1 (1,2,4)**

**READ CYCLE2 (1,3,4)**

**READ CYCLE3 (1,4)**

**NOTES:**

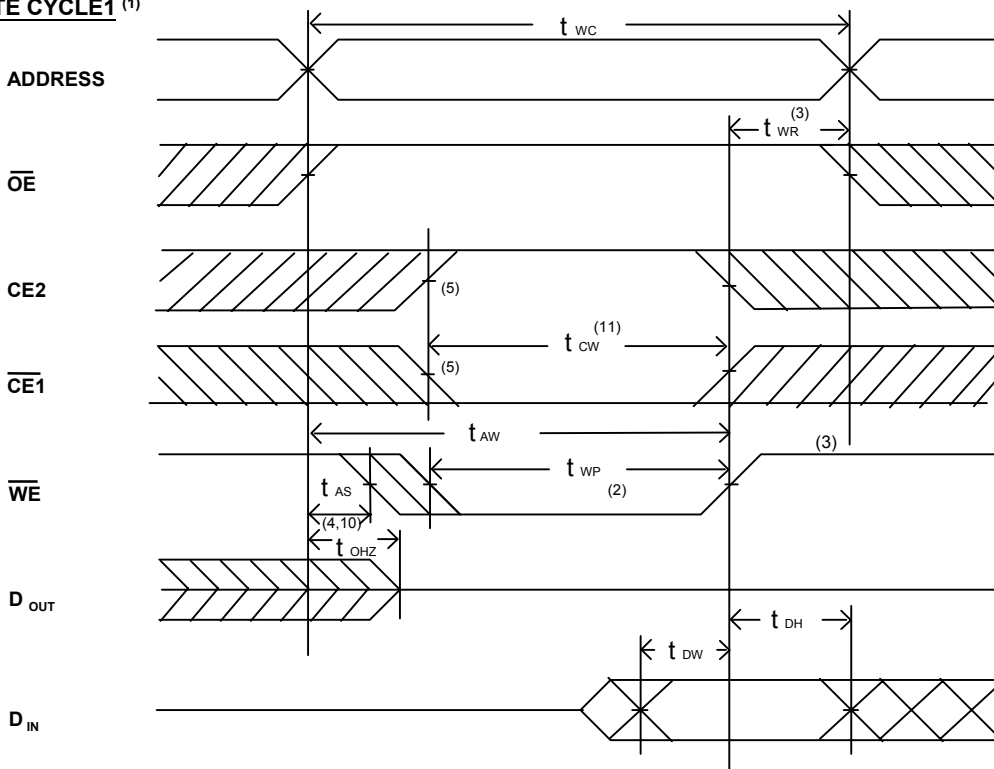
1. WE is high in read Cycle.
2. Device is continuously selected when  $\overline{CE1} = V_{IL}$  and  $CE2 = V_{IH}$ .
3. Address valid prior to or coincident with  $\overline{CE1}$  transition low and CE2 transition high.
4.  $OE = V_{IL}$ .
5. The parameter is guaranteed but not 100% tested.

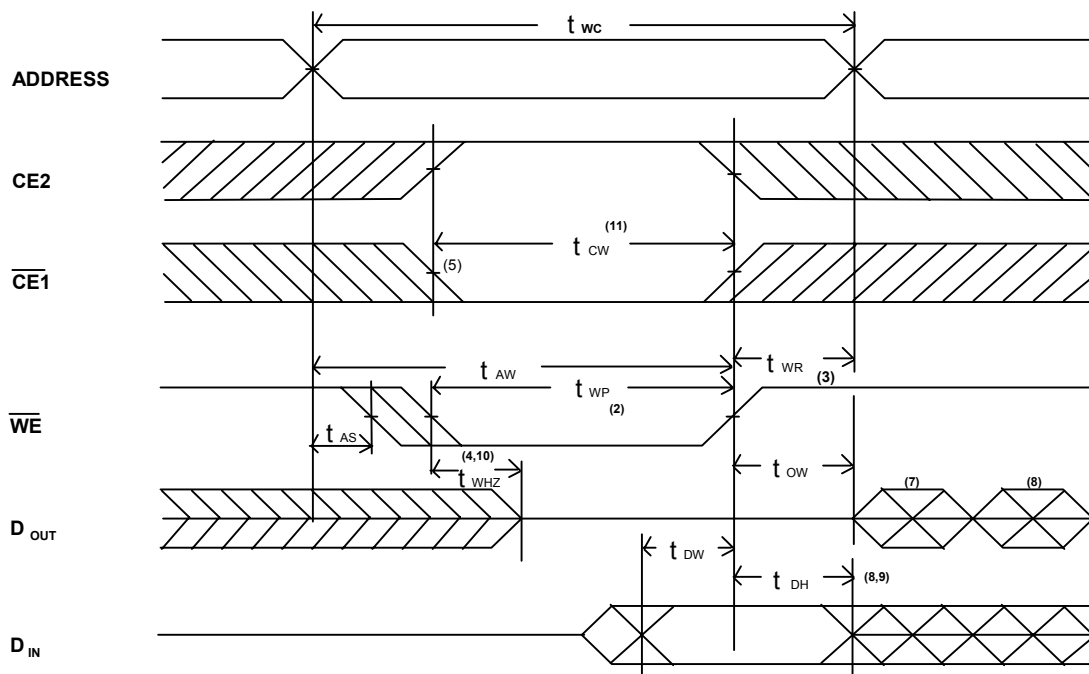
**■ AC ELECTRICAL CHARACTERISTICS ( TA = -40°C to + 85°C )**
**WRITE CYCLE**

JEDEC PARAMETER NAME	PARAMETER NAME	DESCRIPTION	CYCLE TIME : 70ns (Vcc=4.5~5.5V)			CYCLE TIME : 55ns (Vcc=4.5~5.5V)			UNIT
			MIN.	TYP.	MAX.	MIN.	TYP.	MAX.	
$t_{AVAX}$	$t_{wc}$	Write Cycle Time	70	--	--	55	--	--	ns
$t_{E1LWH}$	$t_{cw}$	Chip Select to End of Write	70	--	--	55	--	--	ns
$t_{AVWL}$	$t_{AS}$	Address Set up Time	0	--	--	0	--	--	ns
$t_{AVWH}$	$t_{AW}$	Address Valid to End of Write	70	--	--	55	--	--	ns
$t_{WLWH}$	$t_{WP}$	Write Pulse Width	35	--	--	30	--	--	ns
$t_{WHAX}$	$t_{WR}$	Write Recovery Time ( $\overline{CE2}, \overline{CE1}, \overline{WE}$ )	0	--	--	0	--	--	ns
$t_{WLOZ}$	$t_{WHZ}$	Write to Output in High Z	--	--	30	--	--	25	ns
$t_{DVWH}$	$t_{DW}$	Data to Write Time Overlap	30	--	--	25	--	--	ns
$t_{WHDX}$	$t_{DH}$	Data Hold from Write Time	0	--	--	0	--	--	ns
$t_{GHOZ}$	$t_{OHZ}$	Output Disable to Output in High Z	--	--	30	--	--	25	ns
$t_{WHQX}$	$t_{OW}$	End of Write to Output Active	5	--	--	5	--	--	ns

**■ SWITCHING WAVEFORMS (WRITE CYCLE)**
**WRITE CYCLE1 <sup>(1)</sup>**

**WRITE CYCLE2 (1,6)**

**NOTES:**

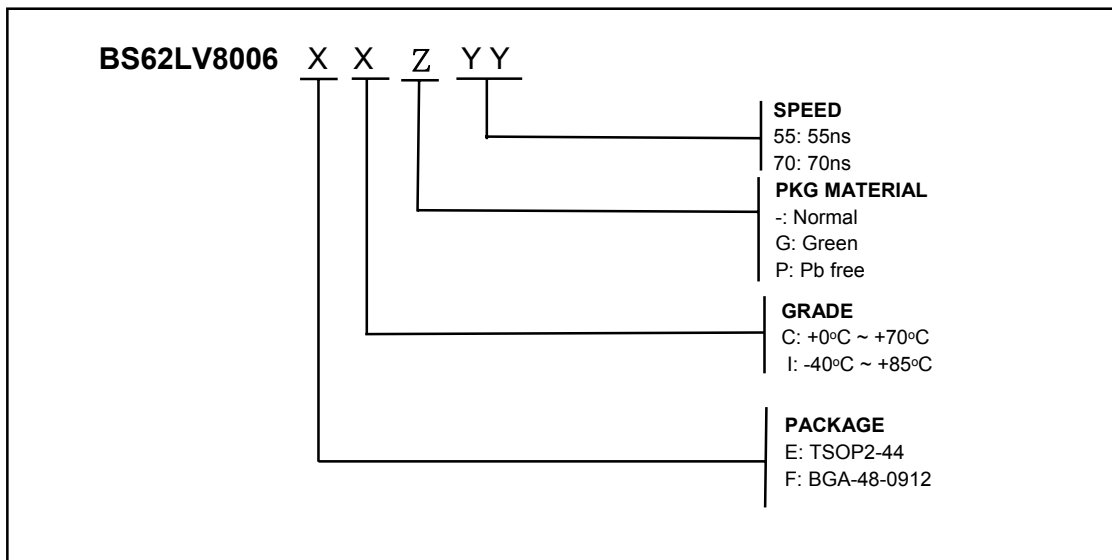
1.  $\overline{WE}$  must be high during address transitions.
2. The internal write time of the memory is defined by the overlap of CE2,  $\overline{CE1}$  and  $\overline{WE}$  low. All signals must be active to initiate a write and any one signal can terminate a write by going inactive. The data input setup and hold timing should be referenced to the second transition edge of the signal that terminates the write.
3.  $t_{wr}$  is measured from the earlier of CE2 going low, or  $\overline{CE1}$  or  $\overline{WE}$  going high at the end of write cycle.
4. During this period, DQ pins are in the output state so that the input signals of opposite phase to the outputs must not be applied.
5. If the  $\overline{CE2}$  high transition or CE1 low transition occurs simultaneously with the  $\overline{WE}$  low transitions or after the  $\overline{WE}$  transition, output remain in a high impedance state.
6. OE is continuously low ( $OE = V_{IL}$ ).
7. D<sub>OUT</sub> is the same phase of write data of this write cycle.
8. D<sub>OUT</sub> is the read data of next address.
9. If CE2 is high or  $\overline{CE1}$  is low during this period, DQ pins are in the output state. Then the data input signals of opposite phase to the outputs must not be applied to them.
10. The parameter is guaranteed but not 100% tested.
11.  $t_{cw}$  is measured from the later of CE2 going high or  $\overline{CE1}$  going low to the end of write.

**ORDERING INFORMATION**

Note:

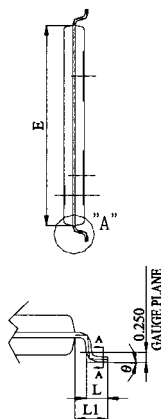
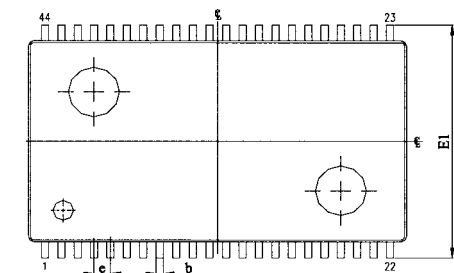
BSI (Brilliance Semiconductor Inc.) assumes no responsibility for the application or use of any product or circuit described herein. BSI does not authorize its products for use as critical components in any application in which the failure of the BSI product may be expected to result in significant injury or death, including life-support systems and critical medical instruments.

**PACKAGE DIMENSIONS**

SYMBOL	UNIT	INCH	MM
A		0.0433± 0.004	1.10± 0.10
A1		0.004± 0.002	0.10± 0.05
A2		0.039± 0.002	1.00± 0.05
b		0.012 ~ 0.018	0.30 ~ 0.45
b1		0.012 ~ 0.016	0.30 ~ 0.40
c		0.005 ~ 0.008	0.12 ~ 0.21
c1		0.005 ~ 0.006	0.12 ~ 0.16
D		0.725± 0.004	18.41± 0.10
E		0.400± 0.004	10.16± 0.10
E1		0.463± 0.008	11.76± 0.20
e		0.0315± 0.004	0.80± 0.10
L		0.0197± 0.004	0.50± 0.10
L1		0.0315± 0.004	0.80± 0.10
y		0.004 Max.	0.1 Max.
θ		0° ~ 8°	0° ~ 8°

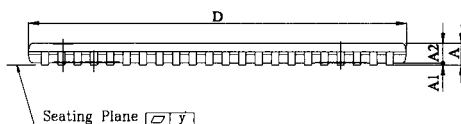

DETAIL "A" (2:1)

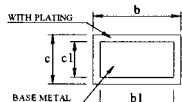

SECTION A-A

**TSOP2-44**

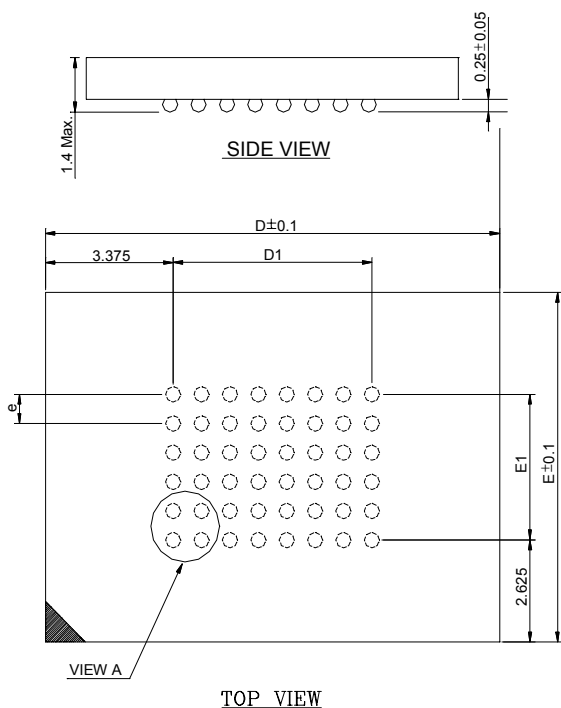

**■ PACKAGE DIMENSIONS (continued)**

**NOTES:**

- 1: CONTROLLING DIMENSIONS ARE IN MILLIMETERS.
- 2: PIN#1 DOT MARKING BY LASER OR PAD PRINT.
- 3: SYMBOL "N" IS THE NUMBER OF SOLDER BALLS.

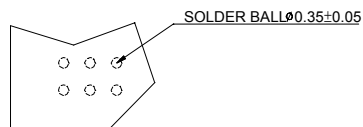
N	D	E	D1	E1	e
48	12.0	9.0	5.25	3.75	0.75

**VIEW A**

**48 mini-BGA (9mm x 12mm)**