

Ceramic Capacitors

For Smoothing SMD

C Series

FEATURES

- Providing capacitance values in the range of electrolytic types and long service life, this product is recommended for high-reliability power supply applications.
- Low ESR and excellent frequency characteristics make this capacitor a superior choice for high-frequency and high-density power supplies.

APPLICATIONS

DC to DC converters, switching power supplies.

PRODUCT IDENTIFICATION

C 3225 X7R 1E 105 M □
(1) (2) (3) (4) (5) (6) (7)

(1) Series name

(2) Dimensions L×W

3225	3.2×2.5mm
4532	4.5×3.2mm
5750	5.7×5.0mm

(3) Capacitance temperature characteristics
Class 2

Temperature characteristics	Capacitance change	Temperature range
X7R	±15%	-55 to +125°C
X5R	±15%	-55 to +85°C
Y5V	+22, -82%	-30 to +85°C

(4) Rated voltage E_{dc}

0J	6.3V
1A	10V
1C	16V
1E	25V
1H	50V

(5) Nominal capacitance

The capacitance is expressed in three digit codes and in units of pico farads (pF).

The first and second digits identify the first and second significant figures of the capacitance.

The third digit identifies the multiplier.

R designates a decimal point.

105	100000pF[1μF]
-----	---------------

(6) Capacitance tolerance

K	±10%
M	±20%
Z	+80, -20%

(7) Packaging style

T	Taping (reel)
B	Bulk

Ceramic Capacitors

For Smoothing

SMD

C Series

C3225 (EIA:CC1210) TYPE SHAPES AND DIMENSIONS

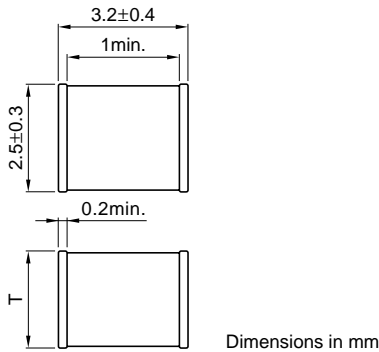

CAPACITANCE RANGES:

CLASS 2

TEMPERATURE CHARACTERISTICS: X7R(±15%), X5R(±15%)

RATED VOLTAGE Edc: 50V

Capacitance (pF)	Tolerance	Thickness (mm)	Part No.
680000	±10%	1.6±0.2	C3225X7R1H684K
	±20%	1.6±0.2	C3225X7R1H684M
1000000	±10%	1.6±0.2	C3225X7R1H105K
[1μF]	±20%	1.6±0.2	C3225X7R1H105M
1500000	±10%	2.0±0.2	C3225X7R1H155K
[1.5μF]	±20%	2.0±0.2	C3225X7R1H155M
2200000*	±10%	2.5±0.3	C3225X5R1H225K
[2.5μF]	±20%	2.5±0.3	C3225X5R1H225M
3300000*	±10%	2.5±0.3	C3225X5R1H335K
[3.3μF]	±20%	2.5±0.3	C3225X5R1H335M

* X5R only

RATED VOLTAGE Edc: 25V

Capacitance (pF)	Tolerance	Thickness (mm)	Part No.
3300000	±10%	1.6±0.2	C3225X7R1E335K
[3.3μF]	±20%	1.6±0.2	C3225X7R1E335M
4700000	±10%	2.0±0.2	C3225X7R1E475K
[4.7μF]	±20%	2.0±0.2	C3225X7R1E475M

RATED VOLTAGE Edc: 16V

Capacitance (pF)	Tolerance	Thickness (mm)	Part No.
6800000	±10%	2.0±0.2	C3225X5R1C685K
[6.8μF]	±20%	2.0±0.2	C3225X5R1C685M
10000000	±10%	2.0±0.2	C3225X5R1C106K
[10μF]	±20%	2.0±0.2	C3225X5R1C106M

TEMPERATURE CHARACTERISTICS: X5R(±15%)

RATED VOLTAGE Edc: 10V

Capacitance (pF)	Tolerance	Thickness (mm)	Part No.
15000000	±20%	2.3±0.2	C3225X5R1A156M
[15μF]			
22000000	±20%	2.3±0.2	C3225X5R1A226M
[22μF]			

RATED VOLTAGE Edc: 6.3V

Capacitance (pF)	Tolerance	Thickness (mm)	Part No.
22000000	±20%	2.5±0.3	C3225X5R0J226M
[22μF]			
33000000	±20%	2.5±0.3	C3225X5R0J336M
[33μF]			
47000000	±20%	2.5±0.3	C3225X5R0J476M
[47μF]			

TEMPERATURE CHARACTERISTICS: Y5V(+22, -82%)

RATED VOLTAGE Edc:50V

Capacitance (pF)	Tolerance	Thickness (mm)	Part No.
4700000	+80, -20%	1.6±0.2	C3225Y5V1H475Z
[4.7μF]			

RATED VOLTAGE Edc:25V

Capacitance (pF)	Tolerance	Thickness (mm)	Part No.
10000000	+80, -20%	1.6±0.2	C3225Y5V1E106Z
[10μF]			

RATED VOLTAGE Edc:16V

Capacitance (pF)	Tolerance	Thickness (mm)	Part No.
22000000	+80, -20%	2.0±0.2	C3225Y5V1C226Z
[22μF]			

RATED VOLTAGE Edc:10V

Capacitance (pF)	Tolerance	Thickness (mm)	Part No.
47000000	+80, -20%	2.0±0.2	C3225Y5V1A476Z
[47μF]			

- For more information about products with other capacitance or other data, please contact us.
- Please contact us for the capacitance tolerance ±10% products over 10μF. with temperature characteristics B, X7R and X5R.

Ceramic Capacitors

For Smoothing

SMD

C Series

C4532 (EIA:CC1812) TYPE SHAPES AND DIMENSIONS

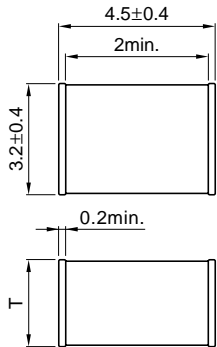

Dimensions in mm

CAPACITANCE RANGES:

CLASS 2

TEMPERATURE CHARACTERISTICS: X7R(±15%), X5R(±15%)

RATED VOLTAGE Edc: 50V

Capacitance (pF)	Tolerance	Thickness (mm)	Part No.
2200000 [2.2μF]	±10% ±20%	1.6±0.2	C4532X7R1H225K C4532X7R1H225M
3300000 [3.3μF]	±10% ±20%	2.0±0.2	C4532X7R1H335K C4532X7R1H335M

RATED VOLTAGE Edc: 25V

Capacitance (pF)	Tolerance	Thickness (mm)	Part No.
4700000 [4.7μF]	±10% ±20%	1.6±0.2	C4532X7R1E475K C4532X7R1E475M
6800000 [6.8μF]	±10% ±20%	2.0±0.2	C4532X7R1E685K C4532X7R1E685M
10000000 [10μF]	±10% ±20%	2.5±0.3	C4532X7R1E106K C4532X7R1E106M
15000000 [15μF]	±20%	2.8±0.3	C4532X5R1E156M

RATED VOLTAGE Edc: 16V

Capacitance (pF)	Tolerance	Thickness (mm)	Part No.
15000000 [15μF]	±20%	2.5±0.3	C4532X5R1C156M
22000000 [22μF]	±20%	2.5±0.3	C4532X5R1C226M

TEMPERATURE CHARACTERISTICS: X5R(±15%)

RATED VOLTAGE Edc: 6.3V

Capacitance (pF)	Tolerance	Thickness (mm)	Part No.
47000000 [47μF]	±20%	2.5±0.3	C4532X5R0J476M
68000000 [68μF]	±20%	2.8±0.3	C4532X5R0J686M
100000000 [100μF]	±20%	2.8±0.3	C4532X5R0J107M

TEMPERATURE CHARACTERISTICS: Y5V(+22, -82%)

RATED VOLTAGE Edc:50V

Capacitance (pF)	Tolerance	Thickness (mm)	Part No.
10000000 [10μF]	+80, -20%	2.0±0.2	C4532Y5V1H106Z

RATED VOLTAGE Edc:25V

Capacitance (pF)	Tolerance	Thickness (mm)	Part No.
22000000 [22μF]	+80, -20%	2.0±0.2	C4532Y5V1E226Z

RATED VOLTAGE Edc:16V

Capacitance (pF)	Tolerance	Thickness (mm)	Part No.
47000000 [47μF]	+80, -20%	2.5±0.3	C4532Y5V1C476Z

RATED VOLTAGE Edc:10V

Capacitance (pF)	Tolerance	Thickness (mm)	Part No.
100000000 [100μF]	+80, -20%	2.5±0.3	C4532Y5V1A107Z

- For more information about products with other capacitance or other data, please contact us.
- Please contact us for the capacitance tolerance ±10% products over 10μF. with temperature characteristics B, X7R and X5R.

Ceramic Capacitors

For Smoothing

SMD

C Series

C5750 (EIA:CC2220) TYPE SHAPES AND DIMENSIONS

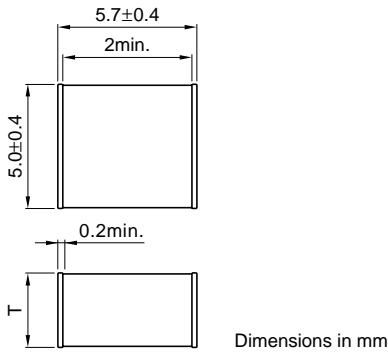

CAPACITANCE RANGES:

CLASS 2 (TEMPERATURE STABLE)

TEMPERATURE CHARACTERISTICS: X7R(±15%), X5R(±5%)

RATED VOLTAGE Edc: 50V

Capacitance (pF)	Tolerance	Thickness (mm)	Part No.
47000000	±10%	2.0±0.2	C5750X7R1H475K
[4.7μF]	±20%	2.0±0.2	C5750X7R1H475M
68000000	±10%	2.5±0.3	C5750X7R1H685K
[6.8μF]	±20%	2.5±0.3	C5750X7R1H685M
100000000*	±10%	2.3±0.2	C5750X5R1H106K
[10μF]	±20%	2.3±0.2	C5750X5R1H106M

* X5R only

RATED VOLTAGE Edc: 25V

Capacitance (pF)	Tolerance	Thickness (mm)	Part No.
10000000	±10%	2.0±0.2	C5750X7R1E106K
[10μF]	±20%	2.0±0.2	C5750X7R1E106M
15000000	±20%	2.3±0.2	C5750X7R1E156M
[15μF]	±20%	2.3±0.2	C5750X7R1E156M
22000000	±20%	2.5±0.3	C5750X7R1E226M
[22μF]	±20%	2.5±0.3	C5750X7R1E226M

TEMPERATURE CHARACTERISTICS: X5R(±15%)

RATED VOLTAGE Edc: 16V

Capacitance (pF)	Tolerance	Thickness (mm)	Part No.
33000000	±20%	2.0±0.2	C5750X5R1C336M
[33μF]	±20%	2.0±0.2	C5750X5R1C336M
47000000	±20%	2.3±0.2	C5750X5R1C476M
[47μF]	±20%	2.3±0.2	C5750X5R1C476M

RATED VOLTAGE Edc: 10V

Capacitance (pF)	Tolerance	Thickness (mm)	Part No.
68000000	±20%	2.3±0.2	C5750X5R1A686M
[68μF]	±20%	2.3±0.2	C5750X5R1A686M

RATED VOLTAGE Edc: 6.3V

Capacitance (pF)	Tolerance	Thickness (mm)	Part No.
100000000	±20%	2.8±0.3	C5750X5R0J107M
[100μF]	±20%	2.8±0.3	C5750X5R0J107M

TEMPERATURE CHARACTERISTICS: Y5V(+22, -82%)

RATED VOLTAGE Edc:50V

Capacitance (pF)	Tolerance	Thickness (mm)	Part No.
22000000	+80, -20%	2.0±0.2	C5750Y5V1H226Z
[22μF]	+80, -20%	2.0±0.2	C5750Y5V1H226Z

RATED VOLTAGE Edc:25V

Capacitance (pF)	Tolerance	Thickness (mm)	Part No.
47000000	+80, -20%	2.0±0.2	C5750Y5V1E476Z
[47μF]	+80, -20%	2.0±0.2	C5750Y5V1E476Z

RATED VOLTAGE Edc:16V

Capacitance (pF)	Tolerance	Thickness (mm)	Part No.
100000000	+80, -20%	2.5±0.3	C5750Y5V1C107Z
[100μF]	+80, -20%	2.5±0.3	C5750Y5V1C107Z

- For more information about products with other capacitance or other data, please contact us.
- Please contact us for the capacitance tolerance ±10% products over 10μF with temperature characteristics B, X7R and X5R.

• All specifications are subject to change without notice.