



LA4145

0.6 to 0.9 W AF Power Amplifier for Radio Cassette Recorders

Features

- The LA4145 is especially suited for use in cassette tape recorder, radio-cassette, recorder, stereo cassette player applications.
- 0.6 W typ/ $V_{CC} = 6.0$ V, $R_L = 8 \Omega$, THD = 10%
- 0.9 W typ/ $V_{CC} = 6.0$ V, $R_L = 4 \Omega$, THD = 10%
- Minimum number of external parts required
- Soft clip
- Small pop noise at V_{CC} ON/OFF mode
- Voltage gain fixed at 50 dB.
An external resistor can be connected to reduce this value.

Package Dimensions

unit : mm

3017C-SIP9

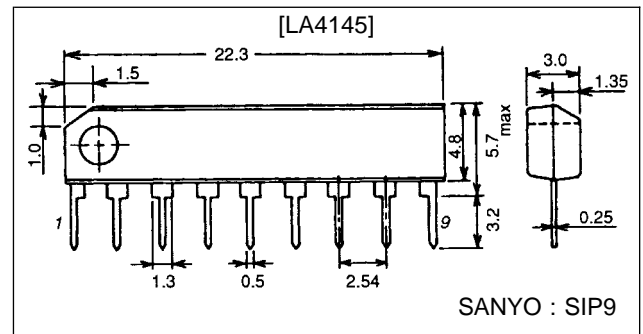

Specifications

Maximum Ratings at $T_a = 25^\circ\text{C}$

Parameter	Symbol	Conditions	Ratings	Unit
Maximum supply voltage	V_{CC} max	Quiescent mode	9	V
		Operating mode $R_L = 8 \Omega$	8	V
Maximum output current	I_O peak		500	mA
Allowable power dissipation	P_d max	$50 \times 50 \text{ mm}^2$ with PCB	0.9	W
Operating temperature	T_{opr}		-20 to +70	$^\circ\text{C}$
Storage temperature	T_{stg}		-40 to +150	$^\circ\text{C}$

Operating Conditions at $T_a = 25^\circ\text{C}$

Parameter	Symbol	Conditions	Ratings	Unit
Recommended supply voltage	V_{CC}		6	V
Recommended load resistance	R_L		4 to 8	Ω
Operating voltage range	V_{CC}		3.6 to 8	V

■ Any and all SANYO products described or contained herein do not have specifications that can handle applications that require extremely high levels of reliability, such as life-support systems, aircraft's control systems, or other applications whose failure can be reasonably expected to result in serious physical and/or material damage. Consult with your SANYO representative nearest you before using any SANYO products described or contained herein in such applications.

■ SANYO assumes no responsibility for equipment failures that result from using products at values that exceed, even momentarily, rated values (such as maximum ratings, operating condition ranges, or other parameters) listed in products specifications of any and all SANYO products described or contained herein.

SANYO Electric Co., Ltd. Semiconductor Business Headquarters

TOKYO OFFICE Tokyo Bldg., 1-10, 1 Chome, Ueno, Taito-ku, TOKYO, 110-8534 JAPAN

LA4145

Operating Characteristics at $T_a = 25^\circ\text{C}$, $V_{CC} = 6.0\text{ V}$, $R_L = 8\ \Omega$, $R_g = 600\ \Omega$, $f = 1\text{ kHz}$

Parameter	Symbol	Conditions	min	typ	max	Unit
Quiescent current	I_{CCO}	LA4145		10	20	mA
Voltage gain	VG		48	50	52	dB
Output power	P_O	THD = 10%, $R_L = 4\ \Omega$		0.9		W
		THD = 10%, $R_L = 8\ \Omega$	0.45	0.6		W
Total harmonic distortion	THD	$P_O = 0.1\text{ W}$		0.2	1.0	%
Input resistance	r_i			30		k Ω
Output noise voltage	V_{NO}	$R_g = 10\text{ k}\Omega$, B.P.F. = 20 Hz to 20 kHz		0.6	1.2	mV
Ripple rejection ratio	SVRR	$R_g = 0$, $f_R = 100\text{ Hz}$, $V_R = 150\text{ mV}$	-35	-40		dB

Proper care in changing voltage gain

An external resistor can be connected in series with the feedback capacitor at pin 2 to reduce the voltage gain. (See RNF-VG characteristic.)

IC usage notes

- Maximum ratings**
 If the IC is used in the vicinity of the maximum ratings, even a slight variation in conditions may cause the maximum ratings to be exceeded, thereby leading to breakdown. Allow an ample margin of variation for supply voltage, etc. and use the IC in the range where the maximum ratings are not exceeded.
- Pin-to-pin short**
 If power is applied when the space between pins is shorted, breakdown or deterioration may occur. When mounting the IC on the board or applying power, make sure that the space between pins is not shorted with solder, etc.
- Radio applications**
 For use in radio applications, keep a good distance between IC and bar antenna.
- Printed circuit pattern**
 When designing the printed circuit pattern, make the power supply, output, and ground lines thicker and shorter and determine the pattern and parts placement so that no feedback loop is formed between input and output. Place power capacitor C_6 , oscillation blocking capacitor C_3 as close to the IC pin as possible to prevent oscillation from occurring. (See the sample printed circuit pattern.)

Description of external parts

C_1 (47 μF)	Feedback capacitor (NF capacitor)	Low cutoff frequency f_L depends on this capacitor. $f_L = 90\text{ Hz}$ for $C_1 = 47\ \mu\text{F}$. Decreasing the capacitor value makes the starting time earlier.
C_2 (100 μF)	Bootstrap capacitor	
C_3 (0.15 μF)	Oscillation blocking capacitor	It is recommended to use a polyester film capacitor being good in temperature characteristic, high frequency characteristic.
C_4 (470 μF)	Output capacitor	
C_5 (47 μF)	Decoupling capacitor	Serves to reject ripple. The starting time depends on this capacitor. Increasing the capacitor value makes the starting time later.
C_6 (470 μF)	Power capacitor	Place as close to the power pin of the IC as possible.
R_1 (30 k Ω)	Input bias resistor	Serves to apply input bias. The input impedance almost entirely depends on this resistor value. If a variable resistor also serves for this purpose, this resistor can be omitted. In this case, it is recommended to use a resistor of 30 k Ω .

Sample Application Circuit:
AF power amplifier

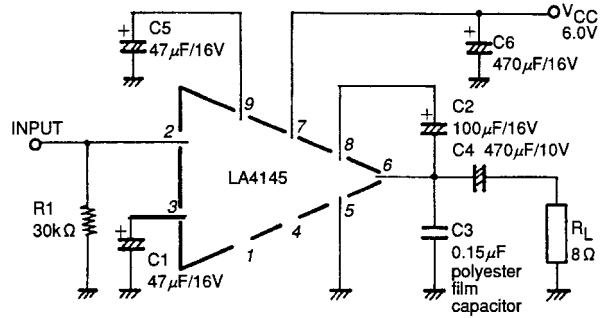
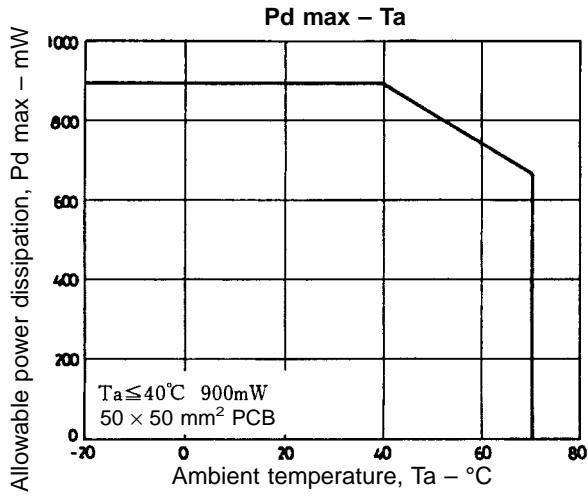

Sample Printed Circuit Pattern (Cu-foiled area)

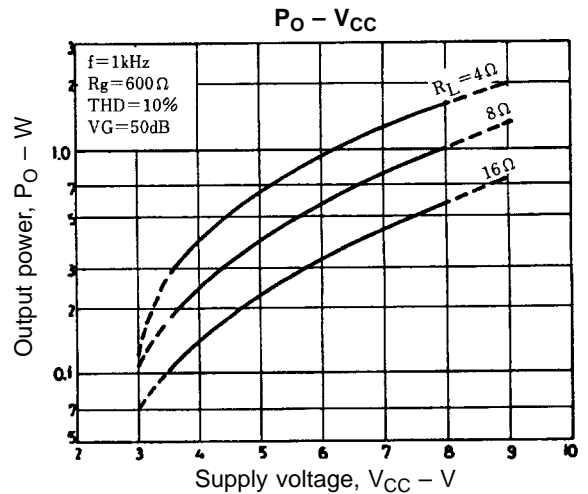
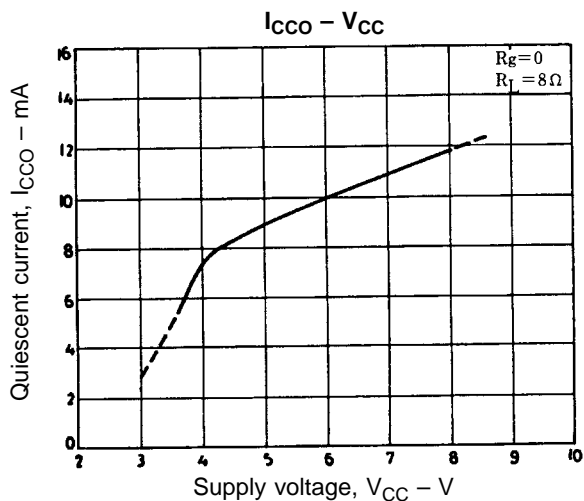
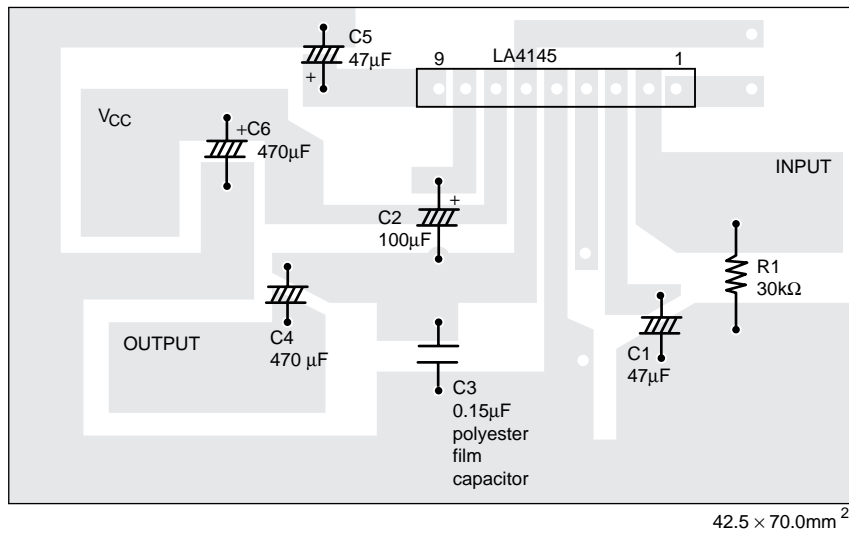

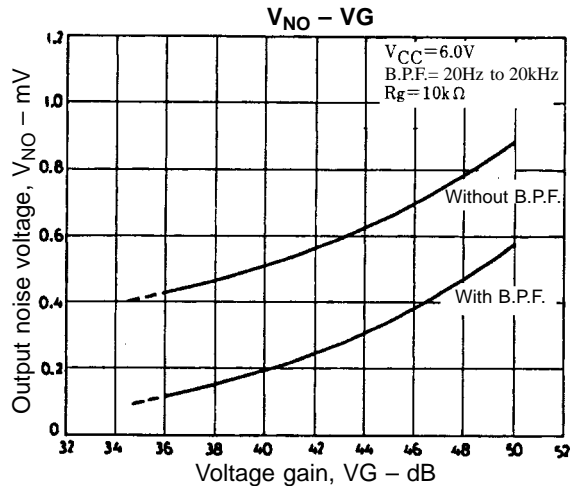
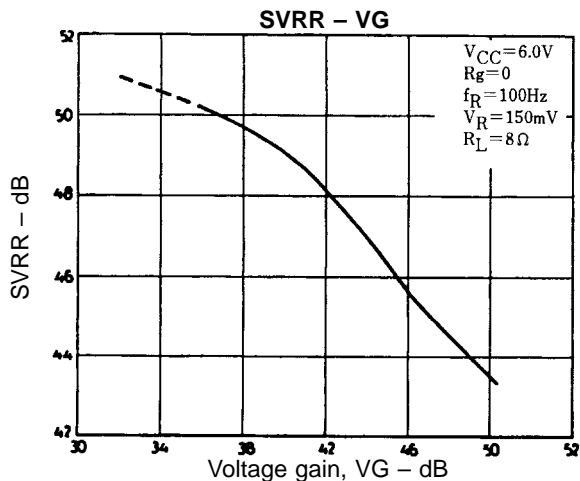
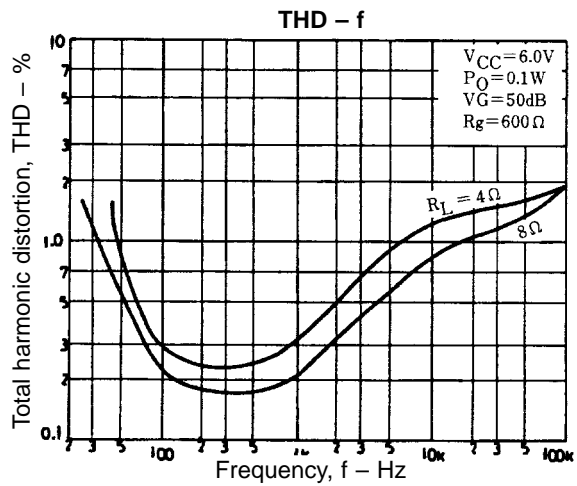
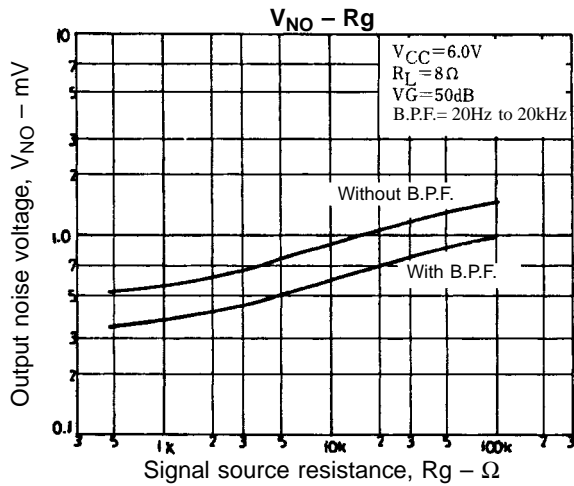
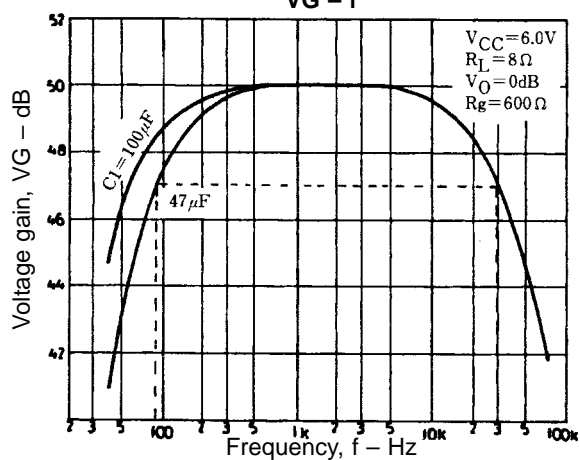
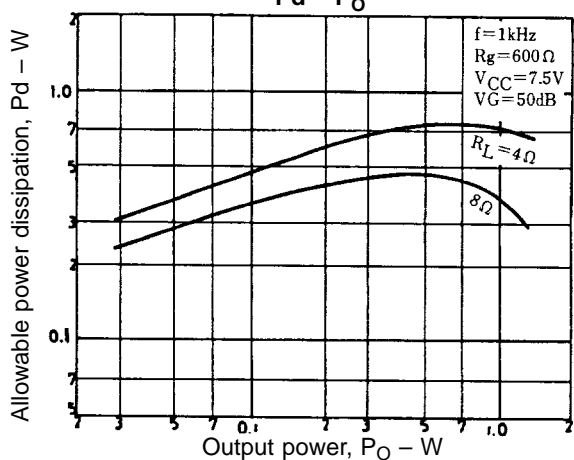
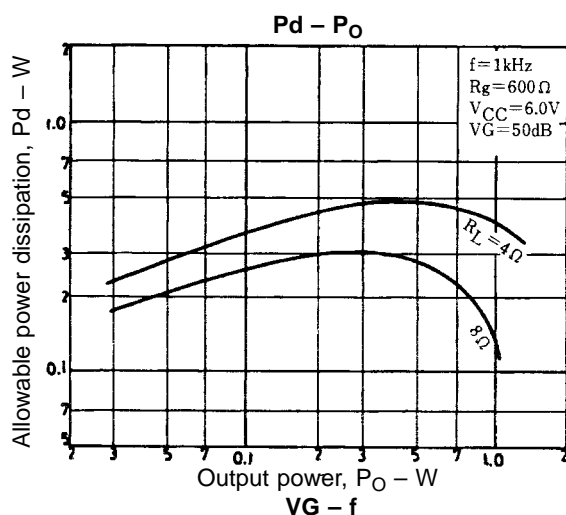
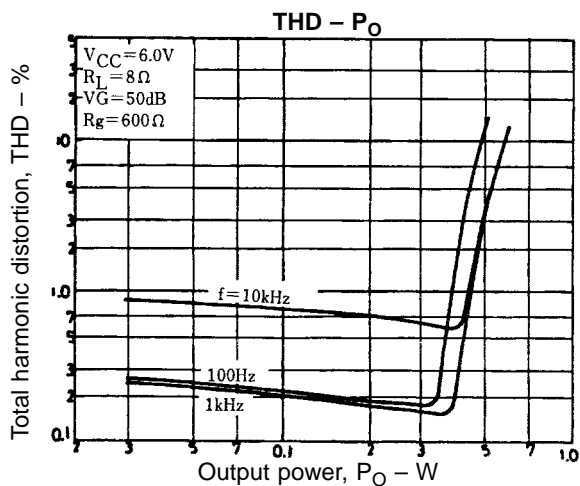

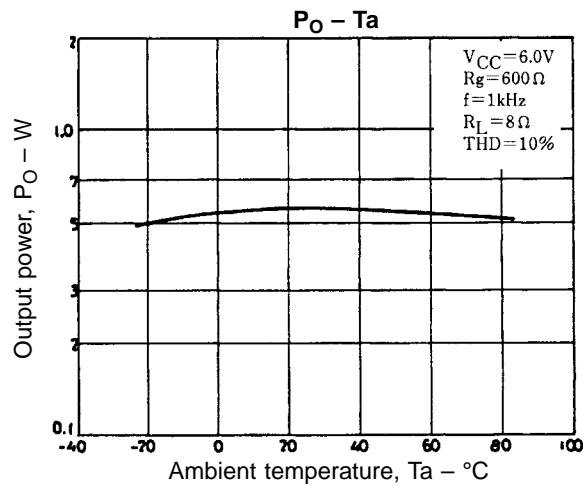
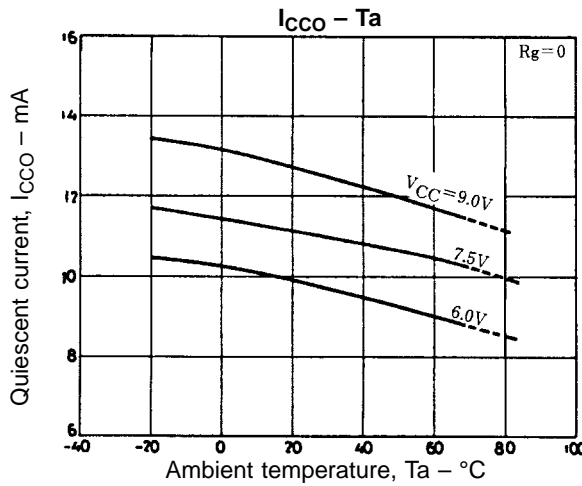
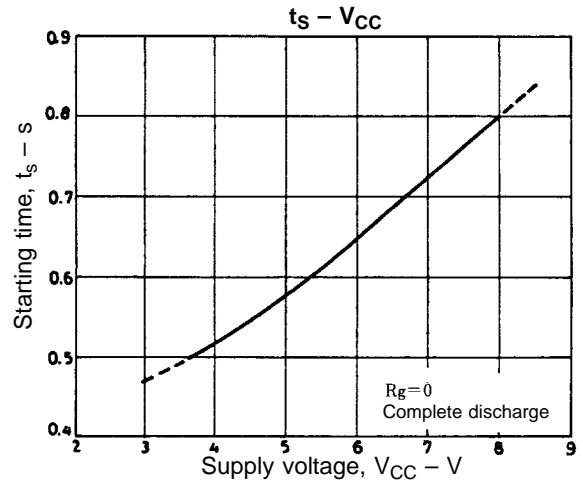
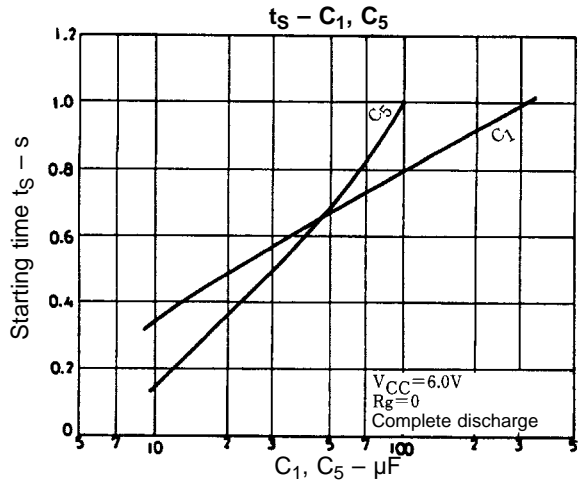
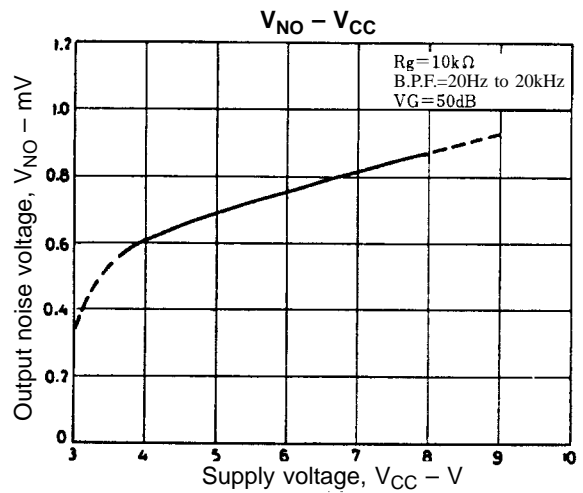
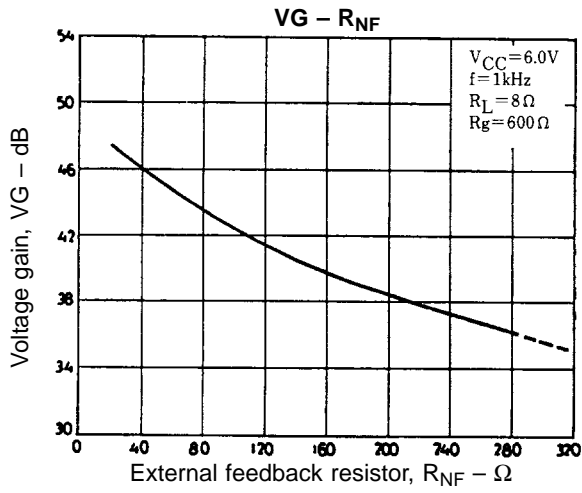

- Specifications of any and all SANYO products described or contained herein stipulate the performance, characteristics, and functions of the described products in the independent state, and are not guarantees of the performance, characteristics, and functions of the described products as mounted in the customer's products or equipment. To verify symptoms and states that cannot be evaluated in an independent device, the customer should always evaluate and test devices mounted in the customer's products or equipment.
- SANYO Electric Co., Ltd. strives to supply high-quality high-reliability products. However, any and all semiconductor products fail with some probability. It is possible that these probabilistic failures could give rise to accidents or events that could endanger human lives, that could give rise to smoke or fire, or that could cause damage to other property. When designing equipment, adopt safety measures so that these kinds of accidents or events cannot occur. Such measures include but are not limited to protective circuits and error prevention circuits for safe design, redundant design, and structural design.
- In the event that any or all SANYO products(including technical data, services) described or contained herein are controlled under any of applicable local export control laws and regulations, such products must not be exported without obtaining the export license from the authorities concerned in accordance with the above law.
- No part of this publication may be reproduced or transmitted in any form or by any means, electronic or mechanical, including photocopying and recording, or any information storage or retrieval system, or otherwise, without the prior written permission of SANYO Electric Co., Ltd.
- Any and all information described or contained herein are subject to change without notice due to product/technology improvement, etc. When designing equipment, refer to the "Delivery Specification" for the SANYO product that you intend to use.
- Information (including circuit diagrams and circuit parameters) herein is for example only ; it is not guaranteed for volume production. SANYO believes information herein is accurate and reliable, but no guarantees are made or implied regarding its use or any infringements of intellectual property rights or other rights of third parties.

This catalog provides information as of May, 1996. Specifications and information herein are subject to change without notice.