

International IOR Rectifier

MBRA120TR

SCHOTTKY RECTIFIER

1.0 Amp

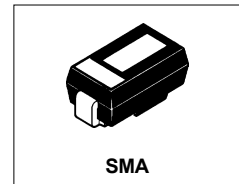

Major Ratings and Characteristics

Characteristics	MBRA120TR	Units
I_{FAV} Rect. Waveform	1.0	A
V_{RRM}	20	V
I_{FSM} @ $t_p = 5 \mu s$ sine	310	A
V_F @1.0Apk, $T_J = 125^\circ C$	0.34	V
T_J range	- 65 to 150	$^\circ C$

Description/ Features

The MBRA120TR surface mount Schottky rectifier has been designed for applications requiring low forward drop and very small foot prints on PC boards. Typical applications are in disk drives, switching power supplies, converters, free-wheeling diodes, battery charging, and reverse battery protection.

- Small foot print, surface mountable
- Low forward voltage drop
- High frequency operation
- Guard ring for enhanced ruggedness and long term reliability

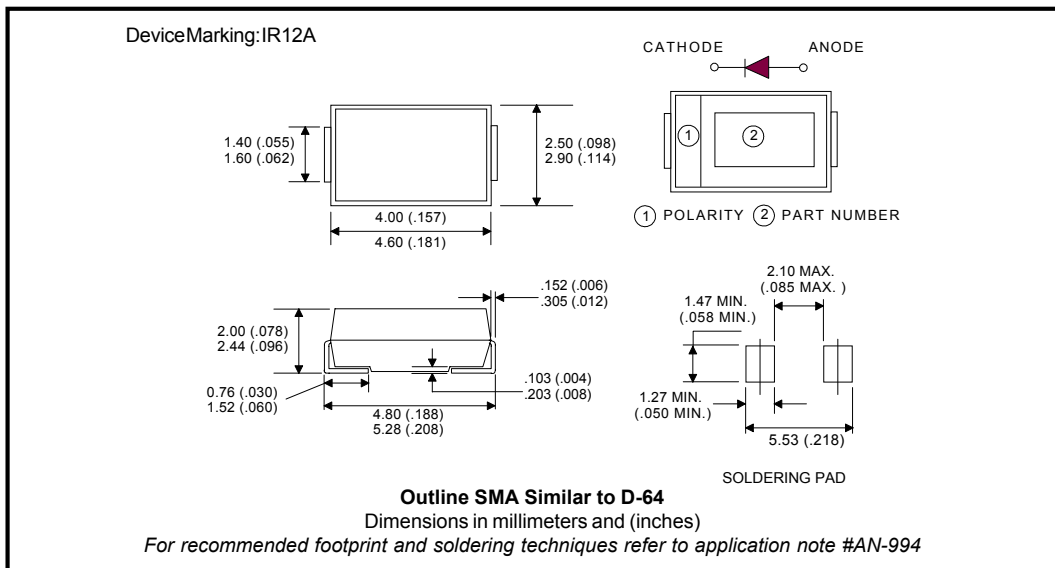

Voltage Ratings

Part number	MBRA120TR
V _R Max. DC Reverse Voltage (V)	20
V _{RWM} Max. Working Peak Reverse Voltage (V)	

Absolute Maximum Ratings

Parameters	Value	Units	Conditions
I _{F(AV)} Max. Average Forward Current	1.0	A	50% duty cycle @ T _L = 136°C, rectangular wave form
I _{FSM} Max. Peak One Cycle Non-Repetitive Surge Current	310	A	Following any rated load condition and with rated V _{RRM} applied
	40		
E _{AS} Non Repetitive Avalanche Energy	3	mJ	T _J = 25 °C, I _{AS} = 1A, L = 10mH
I _{AR} Repetitive Avalanche Current	0.8	A	

Electrical Specifications

Parameters	Typ.	Max.	Units	Conditions
V _{FM} Max. Forward Voltage Drop (1)	0.42	0.45	V	@ 1A
	0.46	0.52	V	@ 2A
	0.33	0.37	V	@ 1A
	0.39	0.45	V	@ 2A
	0.30	0.35	V	@ 1A
	0.36	0.43	V	@ 2A
I _{RM} Max. Reverse Leakage Current (1)	0.015	0.2	mA	T _J = 25 °C
	2.0	6.0	mA	T _J = 100 °C
	7.0	20	mA	T _J = 125 °C
C _T Typical Junction Capacitance	110	-	pF	V _R = 5V _{DC} (test signal range 100kHz to 1Mhz), @ 25°C
L _S Typical Series Inductance	2.0	-	nH	Measured lead to lead 5mm from package body
dv/dt Max. Voltage Rate of Change	-	10000	V/ μs	(Rated V _R)

(1) Pulse Width < 300μs, Duty Cycle < 2%

Thermal-Mechanical Specifications

Parameters	Value	Units	Conditions
T _J Max. Junction Temperature Range (*)	-65 to 150	°C	
T _{stg} Max. Storage Temperature Range	-65 to 150	°C	
R _{thJL} Max. Thermal Resistance Junction to Lead (**)	35	°C/W	DC operation
R _{thJA} Max. Thermal Resistance Junction to Ambient	80	°C/W	
Wt Approximate Weight	0.07(0.002)	gr(oz)	
Case Style	SMA		Similar D-64
Device Marking	IR12A		

(*) $\frac{dP_{tot}}{dT_j} < \frac{1}{R_{th(j-a)}}$ thermal runaway condition for a diode on its own heatsink

(**) Mounted 1 inch square PCB

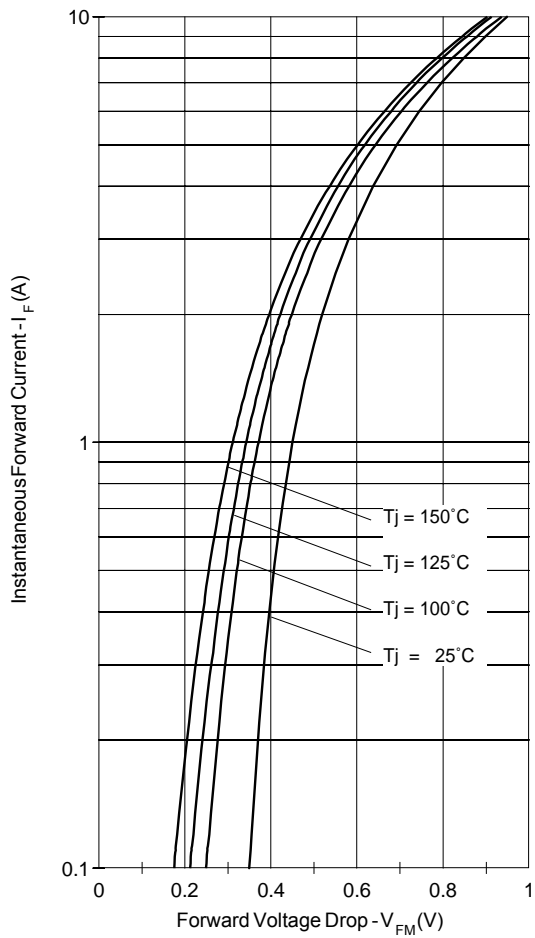

Fig. 1 - Maximum Forward Voltage Drop Characteristics

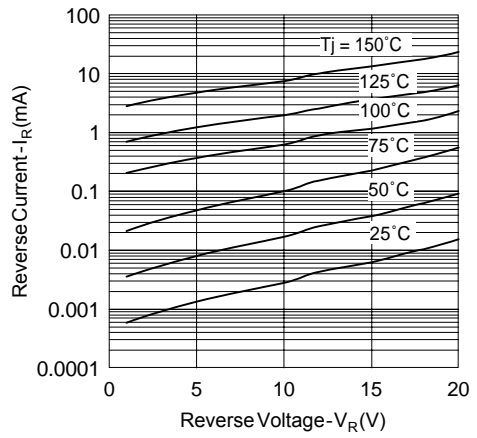

Fig. 2 - Typical Peak Reverse Current Vs. Reverse Voltage

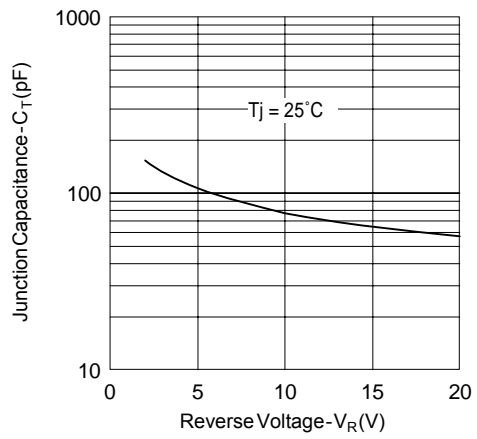

Fig. 3 - Typical Junction Capacitance Vs. Reverse Voltage

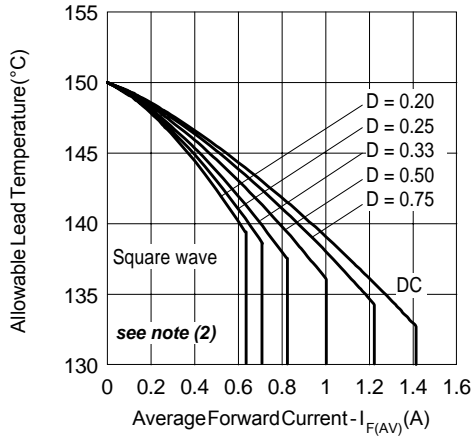

Fig. 4- Maximum Average Forward Current Vs. Allowable Lead Temperature

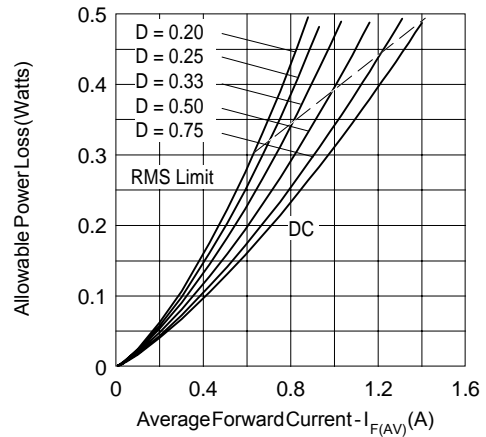

Fig. 5- Maximum Average Forward Dissipation Vs. Average Forward Current

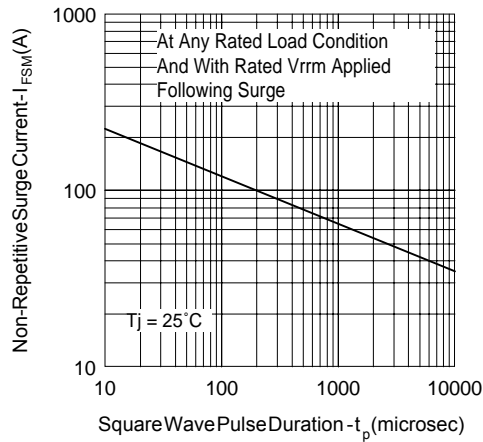
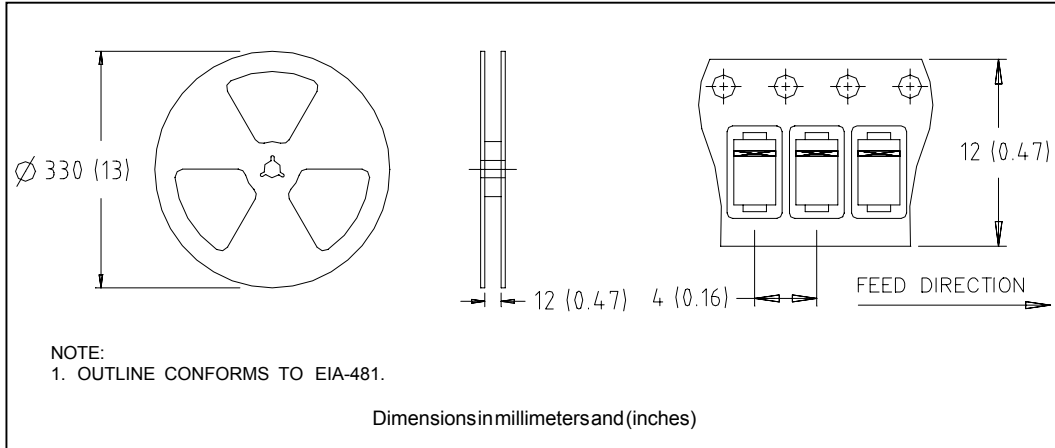

Fig. 6- Maximum Peak Surge Forward Current Vs. Pulse Duration

(2) Formula used: $T_C = T_J - (Pd + Pd_{REV}) \times R_{thJC}$;
 $Pd = \text{Forward Power Loss} = I_{F(AV)} \times V_{FM} @ (I_{F(AV)} / D)$ (see Fig. 6);
 $Pd_{REV} = \text{Inverse Power Loss} = V_{R1} \times I_R (1 - D)$

Tape & Reel Information



Marking & Identification

Each device has marking and identification on two rows.
 - The first row designates the device as manufactured by International Rectifier as indicated by the letters "IR", then Current, Voltage.
 - The second row shows the data code: Year and Week.

See below marking diagram.

FIRST ROW
 IR 12A

SECOND ROW
 Date Code
 YY WW

Ordering Information

MBRA120TR - TAPE AND REEL

WHEN ORDERING, INDICATE THE PART NUMBER AND THE QUANTITY (IN MULTIPLES OF 7500 PIECES).

EXAMPLE: MBRA120TR - 15000PIECES

Data and specifications subject to change without notice.
 This product has been designed for Industrial Level.
 Qualification Standards can be found on IR's Web site.