

PIN Silicon Photodiode

Type OP955

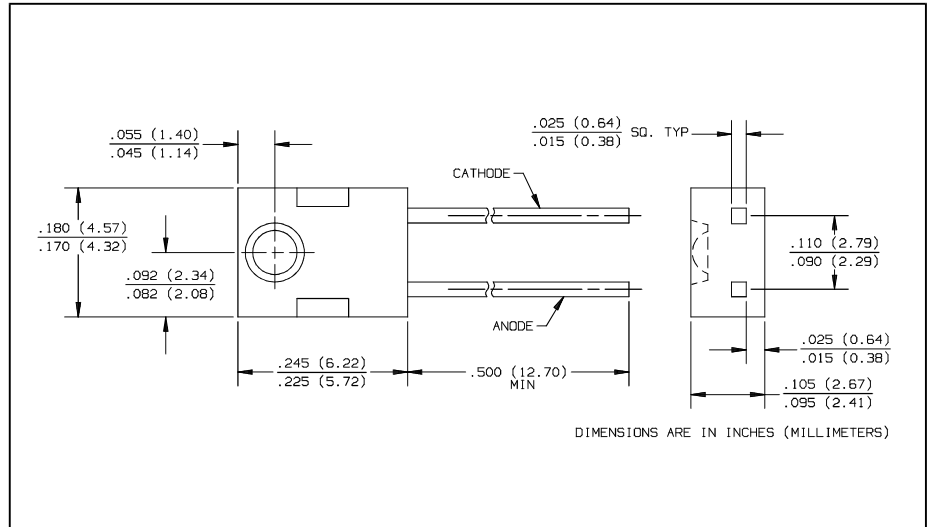
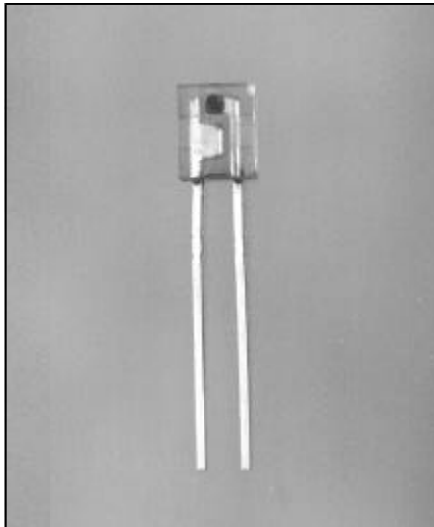

Features

- Wide receiving angle
- Linear response vs. irradiance
- Fast switching time
- Side-looking package ideal for space limited applications

Description

The OP955 devices consists of a PIN silicon photodiode molded in a clear epoxy package which allows spectral response from visible to infrared wavelengths. The wide receiving angle provides relatively even reception over a large area. The side-looking package is designed for easy PC board mounting. The lensing effect of the package allows an acceptance half angle of 45° measured from the optical axis to the half power point. These devices are 100% production tested using infrared light for close correlation with Optek's GaAs and GaAlAs emitters.

Absolute Maximum Ratings ($T_A = 25^\circ\text{C}$ unless otherwise noted)

Reverse Breakdown Voltage	60 V
Storage and Operating Temperature Range	-40°C to $+100^\circ\text{C}$
Lead Soldering Temperature [1/16 inch (1.6 mm) from case for 5 sec. with soldering iron]	$260^\circ\text{C}^{(1)}$
Power Dissipation	$100\text{ mW}^{(2)}$

Notes:

- (1) RMA flux is recommended. Duration can be extended to 10 sec. max. when flow soldering. Max. 20 grams force may be applied to leads when soldering.
- (2) Derate linearly $1.67\text{ mW}/^\circ\text{C}$ above 25°C .
- (3) Light source is an unfiltered GaAs LED with a peak emission wavelength of 935nm and a radiometric intensity level which varies less than 10% over the entire lens surface of the photodiode being tested.
- (4) To calculate typical dark current in μA , use the formula $I_D = 10^{(0.042 T_A - 1.5)}$ where T_A is ambient temperature in $^\circ\text{C}$.

Typical Performance Curves

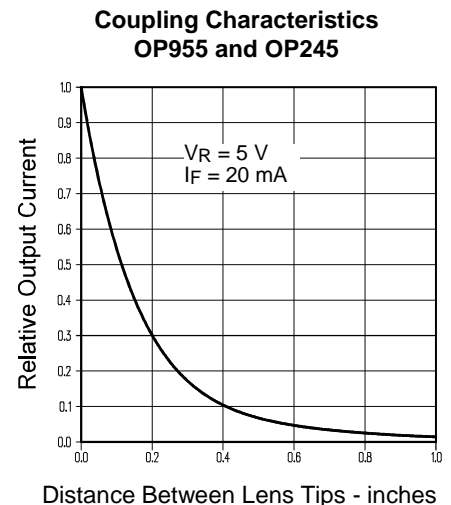
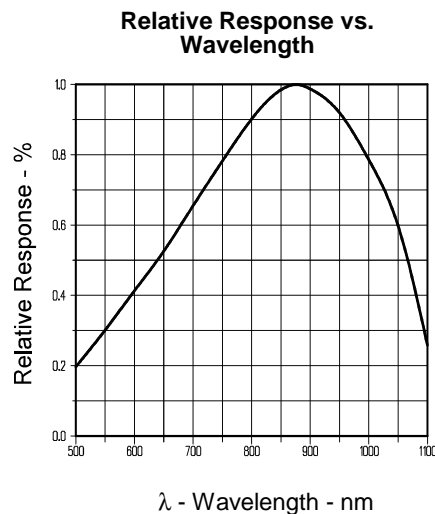

Type OP955

Electrical Characteristics ($T_A = 25^\circ\text{C}$ unless otherwise noted)

SYMBOL	PARAMETER	MIN	TYP	MAX	UNITS	TEST CONDITIONS
I_L	Reverse Light Current	8		18	μA	$V_R = 5\text{ V}$, $E_e = 1\text{ mW/cm}^2(3)$
I_D	Reverse Dark Current		1	60	nA	$V_R = 30\text{ V}$, $E_e = 0$
$V_{(BR)}$	Reverse Breakdown Voltage	60			V	$I_R = 100\text{ }\mu\text{A}$
V_F	Forward Voltage			1.2	V	$I_F = 1\text{ mA}$
C_T	Total Capacitance		4		pF	$V_R = 20\text{ V}$, $E_e = 0$, $f = 1.0\text{ MHz}$
t_r, t_f	Rise Time, Fall Time		5		ns	$V_R = 20\text{ V}$, $\lambda = 850\text{ nm}$, $R_L = 50\text{ }\Omega$

Typical Performance Curves

PHOTOSENSORS

Normalized Light Current vs Reverse Voltage

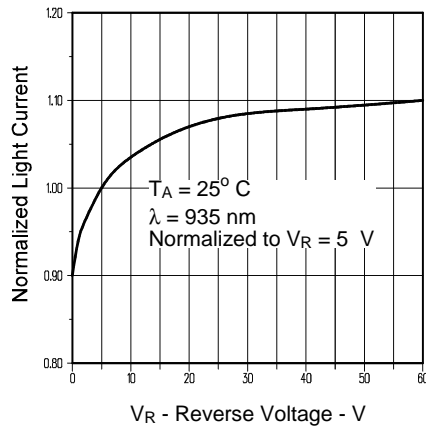

Total Capacitance vs Reverse Voltage

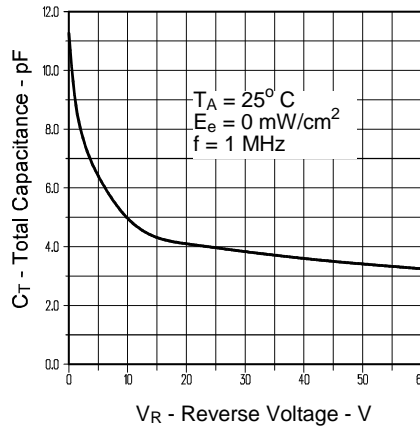

Normalized Light and Dark Current vs Ambient Temperature

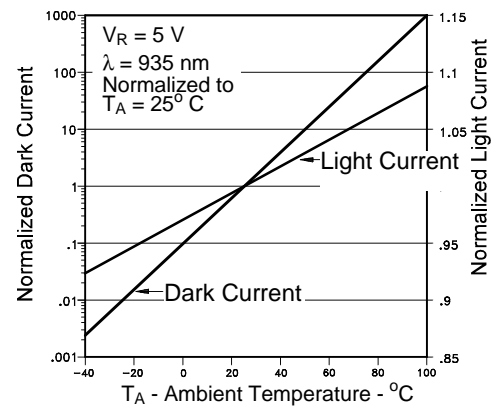

Light Current vs. Irradiance

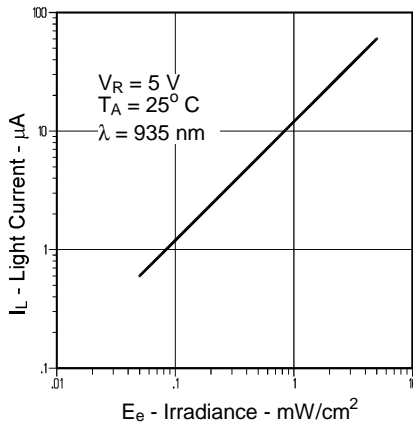

Switching Time Test Circuit

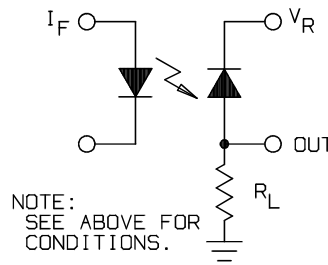

Light Current vs. Angular Displacement

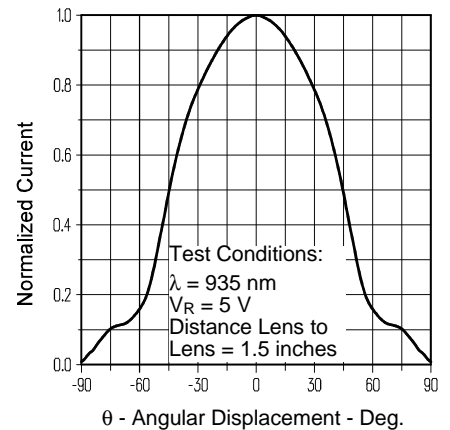

Optek reserves the right to make changes at any time in order to improve design and to supply the best product possible.

Optek Technology, Inc. 1215 W. Crosby Road Carrollton, Texas 75006 (972)323-2200 Fax (972)323-2396