

**Description**

- RF amplifier

**Features**

- High current transition frequency  
 $f_T=550\text{MHz(Typ.)}$ , [ $V_{CE}=6\text{V}$ ,  $I_E=-1\text{mA}$ ]
- Low output capacitance :  
 $C_{ob}=1.4\text{pF(Typ.)}$  [ $V_{CB}=6\text{V}$ ,  $I_E=0$ ]
- Low base time constant and high gain
- Excellent noise response

**Ordering Information**

Type NO.	Marking	Package Code
2SC5345	C5345	TO-92

**Outline Dimensions**

unit : mm

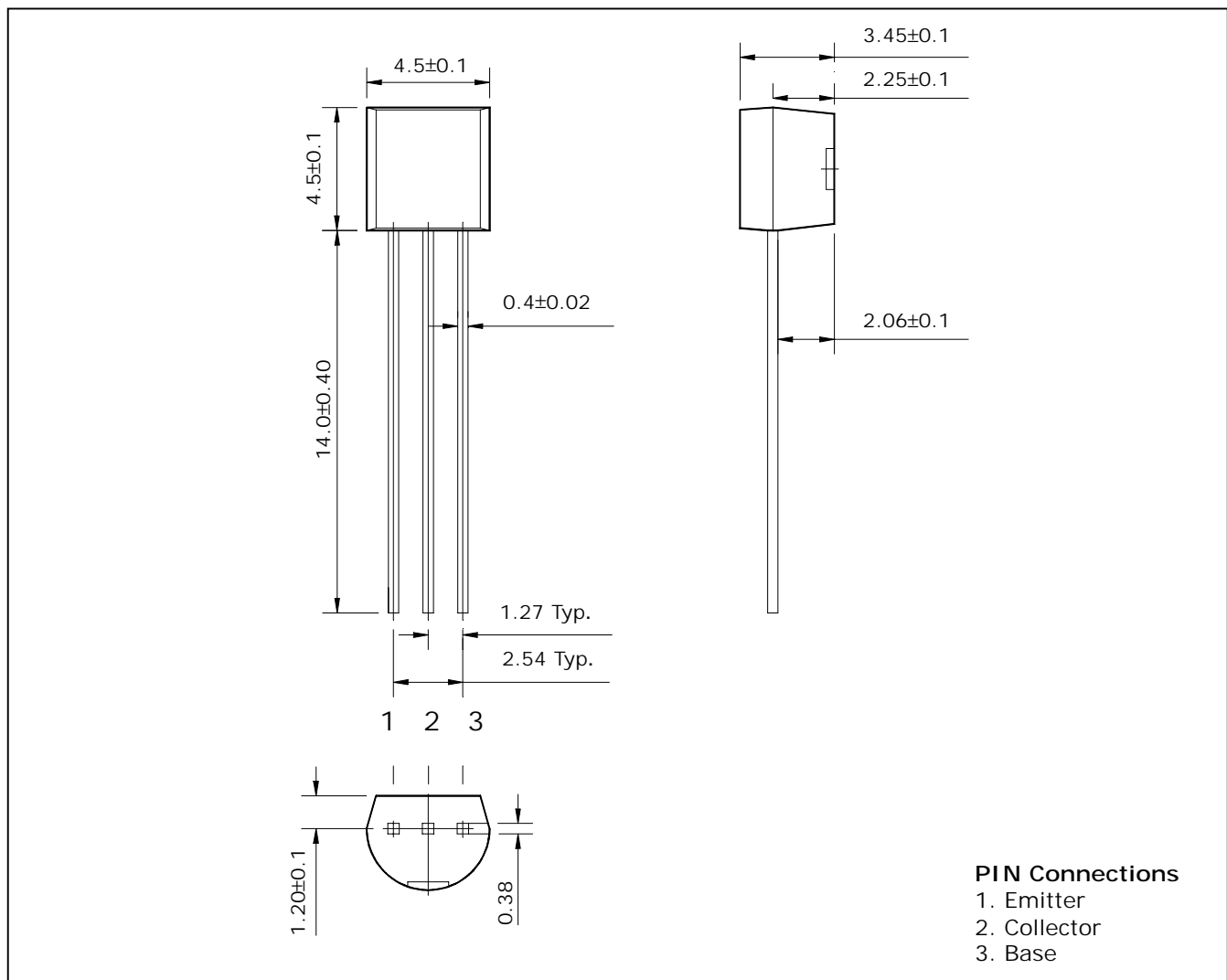

## Absolute maximum ratings

Ta=25°C

Characteristic	Symbol	Ratings	Unit
Collector-Base voltage	$V_{CBO}$	30	V
Collector-Emitter voltage	$V_{CEO}$	20	V
Emitter-Base voltage	$V_{EBO}$	4	V
Collector current	$I_C$	20	mA
Collector dissipation	$P_C$	625	mW
Junction temperature	$T_J$	150	°C
Storage temperature range	$T_{stg}$	-55 ~ 150	°C

## Electrical Characteristics

Ta=25°C

Characteristic	Symbol	Test Condition	Min.	Typ.	Max.	Unit
Collector-Base breakdown voltage	$BV_{CBO}$	$I_C=10\mu A, I_E=0$	30	-	-	V
Collector-Emitter breakdown voltage	$BV_{CEO}$	$I_C=5mA, I_B=0$	20	-	-	V
Emitter-Base breakdown voltage	$BV_{EBO}$	$I_E=10\mu A, I_C=0$	4	-	-	V
Collector cut-off current	$I_{CBO}$	$V_{CB}=30V, I_E=0$	-	-	0.5	$\mu A$
Emitter cut-off current	$I_{EBO}$	$V_{EB}=4V, I_C=0$	-	-	0.5	$\mu A$
DC current gain	$h_{FE}^*$	$V_{CE}=6V, I_C=1mA$	40	-	240	-
Collector-Emitter saturation voltage	$V_{CE(sat)}$	$I_C=10mA, I_B=1mA$	-	-	0.3	V
Transition frequency	$f_T$	$V_{CE}=6V, I_E=-1mA$	-	550	-	MHz
Collector output capacitance	$C_{ob}$	$V_{CB}=6V, I_E=0, f=1MHz$	-	1.4	-	pF

\* :  $h_{FE}$  rank / R : 40~80, O : 70~140, Y : 120~240

Electrical Characteristic Curves

Fig. 1  $P_C - T_a$

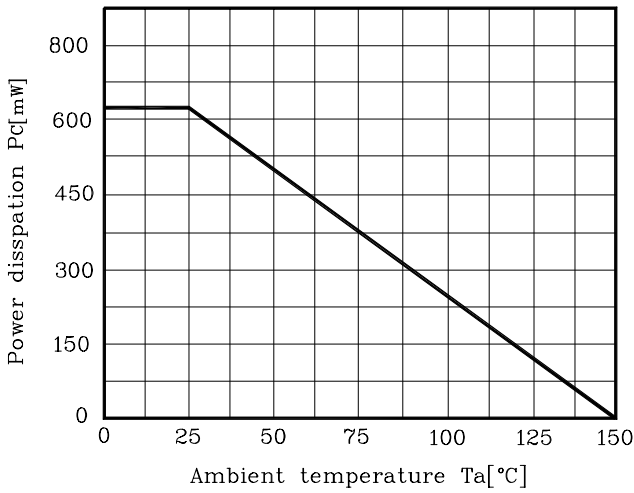

Fig. 2  $I_C - V_{CE}$

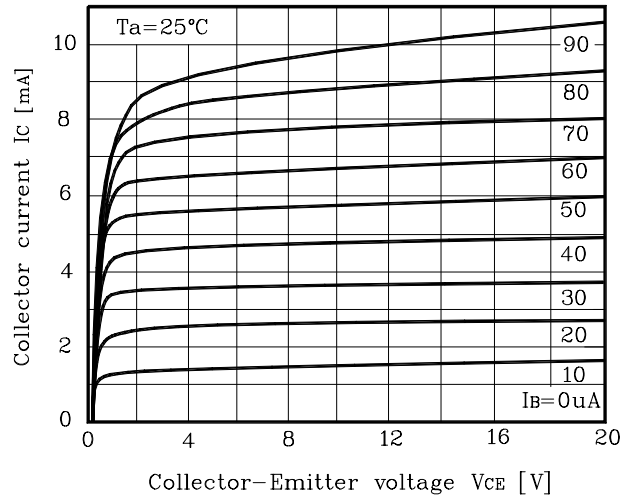

Fig. 3  $h_{FE} - I_C$

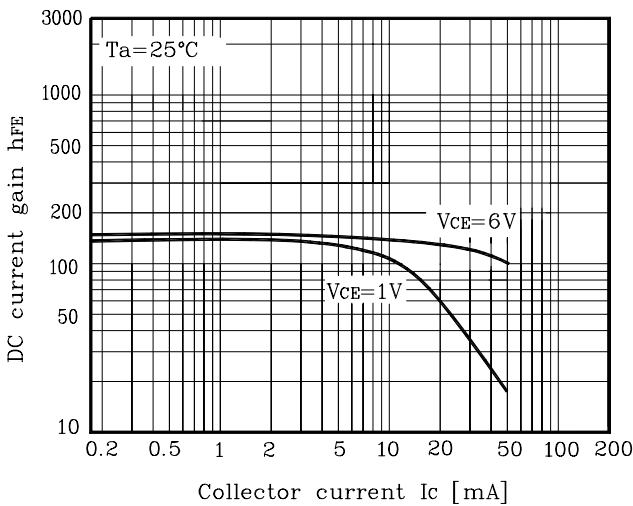

Fig. 4  $f_T - I_E$

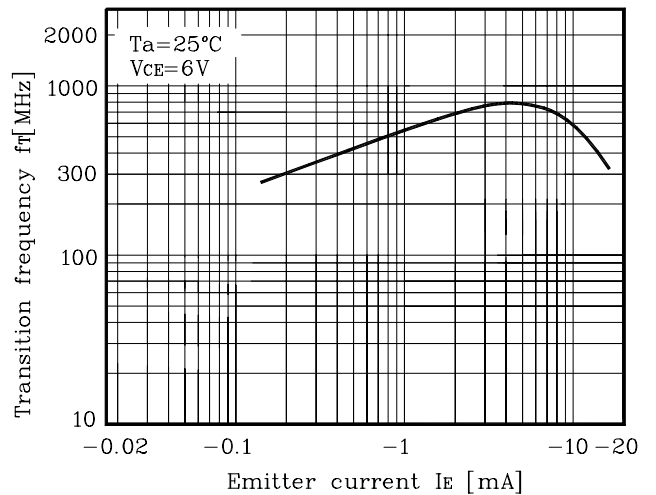

Fig. 5  $C_{ob} - V_{CB}$ ,  $C_{ib} - V_{EB}$

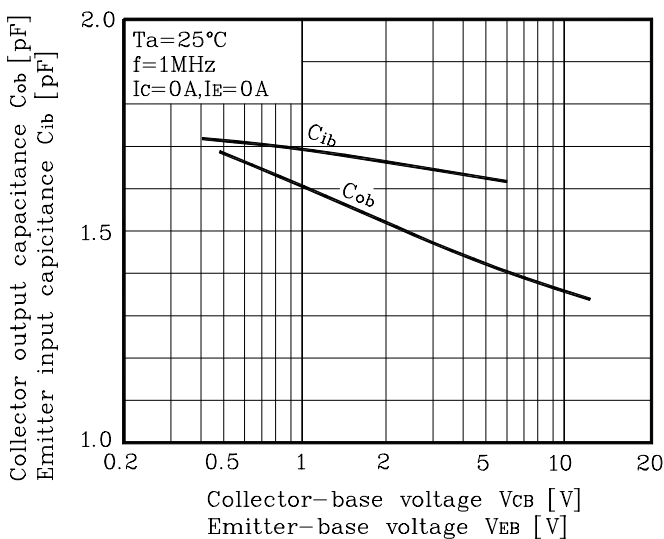
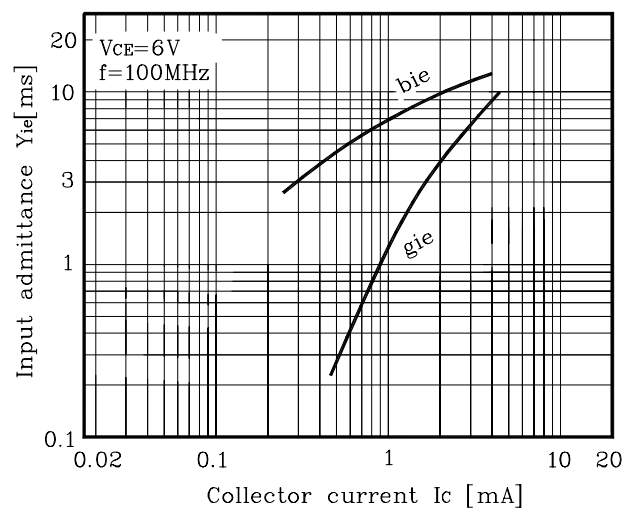

Fig. 6  $Y_{ie} - I_C$



Electrical Characteristic Curves

Fig. 7  $I_C$ - $Y_{oe}$

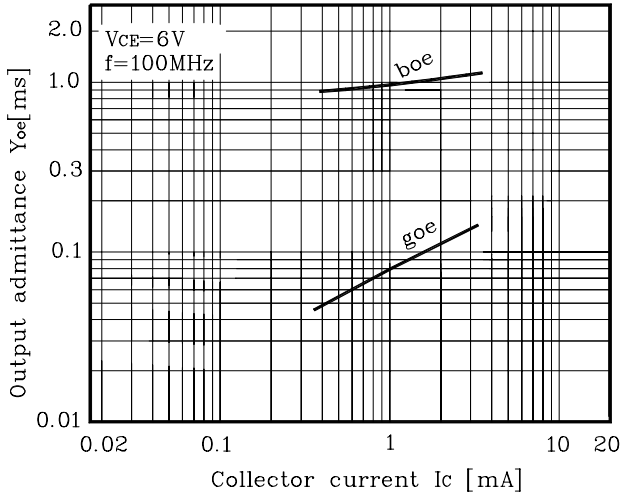

Fig. 8  $I_C$ - $Y_{fe}$

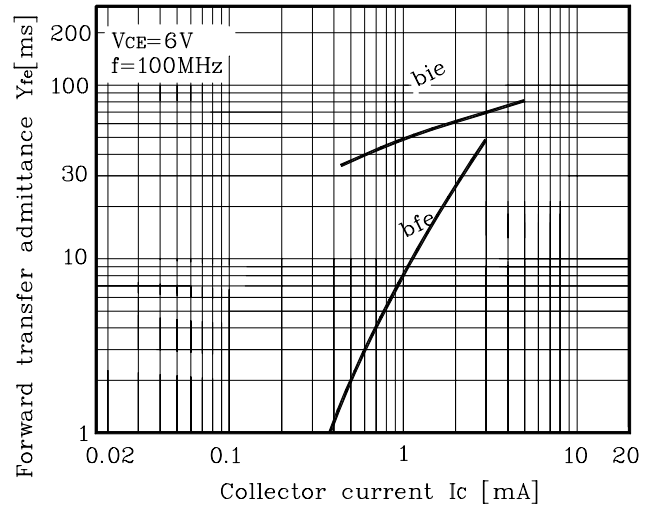

Fig. 9  $I_C$ - $Y_{re}$

