

AN2512S

Electronic View-finder Driving IC

Overview

The AN2512S is an integrated circuit designed for driving the monochrome monitor (view-finder) of the video camera, and it is possible to easily make up a 1.5-inch electronic view finder driving circuit by inputting a video signal.

Features

- Video amp, synchronous separation circuit, horizontal/vertical oscillation circuit, AFC circuit, and vertical driving circuit built-in
- A vertical deflection coil can be driven directly.
- Horizontal oscillating and vertical synchronous separating capacitors built-in
- Low current consumption (I_{CC} 14mA typ. with no load)

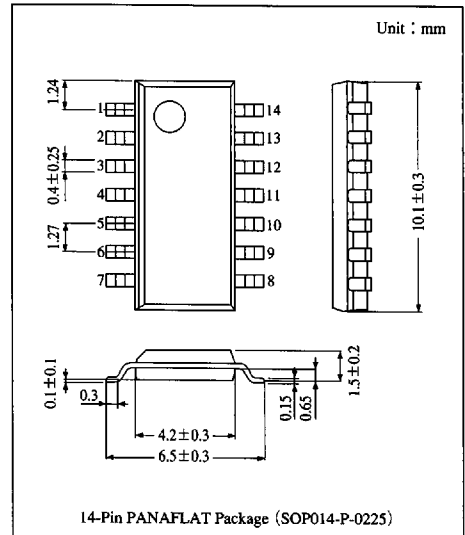

Block Diagram

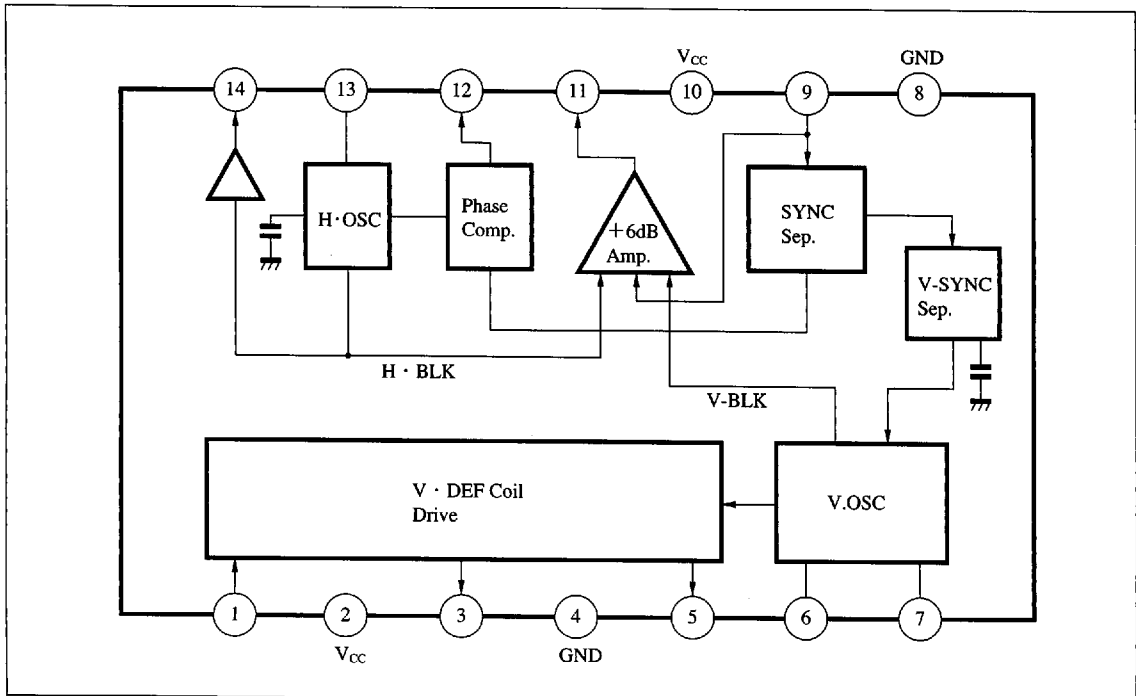

ICs for
Video
Camera

■ Absolute Maximum Ratings (Ta = 25°C)

Parameter	Symbol	Rating	Unit
Supply voltage	V _{CC1} /V _{CC2}	5.5	V
Power dissipation (Ta = 75°C)	P _d	260 *	mW
Operating ambient temperature	T _{opr}	-20 to +75	°C
Storage temperature	T _{stg}	-55 to +125	°C

* Value when mounted on the printed circuit board

■ Recommended Operating Range (Ta = 25°C)

Parameter	Symbol	Range
Operating supply voltage range	V _{CC1} , V _{CC2}	4.5V to 5.3V

■ Electrical Characteristics (V_{CC1} = 5V, V_{CC2} = 5V, Ta = 25°C)

Parameter	Symbol	Condition	min	typ	max	Unit
Circuit current	I _{CC1(2)}	No load	0.35	4.5	8	mA
	I _{CC2(10)}		5.5	10	14	mA
Video amp gain	G _v	Input a video signal (1V _{PP}) to Pin ^⑨ , measure the output of Pin ^⑪	5.1	6.5	7.9	dB
Video amp dynamic range	DR _v	Input a video signal (1.3V _{PP}) to Pin ^⑨ , measure the output of Pin ^⑪	1.7	2.1	2.5	V
Synchronous separating capability (1)	H _{Sep1}	Input only SYNC to Pin ^⑨ and measure the minimum level at which synchronization is provided.	0.2	—	—	V
Synchronous separating capability (2)	H _{Sep2}	Input SYNC (0.29V _{PP}) plus video component to Pin ^⑨ and measure the maximum video level at which synchronization is provided.	—	—	1.3	V
Video signal HD width	τ _{HD}	Measure the time from the falling of input HD to blanking OFF of Pin ^⑪ output.	7.5	8.5	9.5	μs
AFC output HD width	τ _{ARCHD}	Input a signal to Pin ^⑨ and measure while Pin ^⑭ is Lo.	11	12	13	μs
Horizontal free-oscillation frequency	f _{HO}	Measure the output frequency of Pin ^⑭ in the horizontal free oscillation mode.	13.75	15.75	17.75	kHz
AFC lock range	f _{AFC}	Change the frequency of input signal to Pin ^⑨ and measure the synchronizing frequency.	15.25	15.75	16.25	kHz
AFC control sensitivity	β	Flow in and out current to Pin ^⑬ and measure the difference in frequency of Pin ^⑭ output.	720	840	960	Hz/μA
Vertical separating time	t _{Vsep}	Input a signal from Pin ^⑨ and measure the difference in falling between Pin ^⑤ output and input VD.	750	850	950	μs
Video signal VD width	τ _{VD}	Measure the time from the falling of input VD signal to blanking OFF of Pin ^⑪ output.	1	1.2	1.4	ms
Vertical free-oscillation frequency	f _{VO}	Measure the oscillation frequency of Pin ^③ in the vertical free-oscillation mode.	50	54	58	Hz
Vertical deflection output amplitude (1)	v _{VDEF(1)}	Input a signal (1V _{PP}) from Pin ^⑨ and measure the output of Pin ^⑤ .	1.4	1.7	2	V
Vertical deflection output amplitude (2)	v _{VDEF(2)}	Input a signal (1V _{PP}) from Pin ^⑨ and measure the output of Pin ^③ .	1.4	1.7	2	V
Vertical output dynamic range (1)	DR _{VDEF(1)}	Input a signal (1V _{PP}) from Pin ^⑨ and measure the output of Pin ^⑤ .	2.1	2.5	2.9	V
Vertical output dynamic range (2)	DR _{VDEF(2)}	Input a signal (1V _{PP}) from Pin ^⑨ and measure the output of Pin ^③ .	2.1	2.5	2.9	V

■ 6932852 0014679 42T ■

Panasonic

Application Circuit

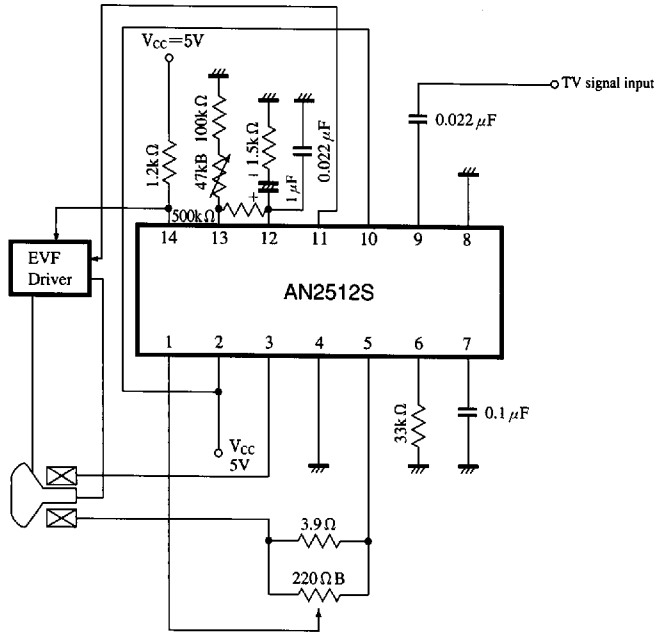

Pin Descriptions







Pin No.	Pin name	Typ. waveform	Description	Equivalent circuit
1	Vertical size control input		Control the V size of the vertical deflection coil driving pin.	
2	Power Pin		Vertical deflection driving circuit V _{cc}	
3	Vertical deflection coil driving Pin①		Vertical deflection coil driving output	
4	GND		Vertical deflection driving circuit GND	
5	Vertical deflection coil driving Pin②		Vertical deflection coil driving output (inversion of Pin③)	
6	Vertical oscillating resistor pin		Vertical oscillating resistor pin	

ICs for Video Camera

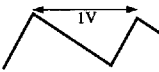
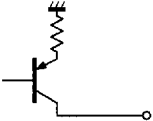
6932852 0014680 141

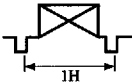
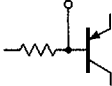
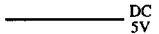
Panasonic

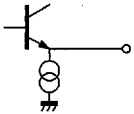
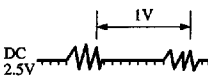
■ Pin Descriptions (cont.)

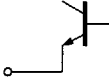
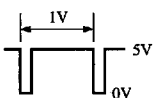
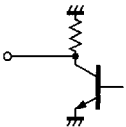
Pin No.	Pin name	Typ. waveform	Description	Equivalent circuit
7	Vertical oscillating capacitor pin		Determines the vertical free-oscillation frequency by the resistor of Pin⑥ and capacitor of Pin⑦.	
8	GND		Main circuit GND	
9	Video input		Clamped to the video signal input pin (1.6V).	
10	Power pin		Main circuit V _{CC}	
11	Video amp output pin		Amplified to the video amp signal output (6.5dB).	
12	Phase comparator output		The output DC of the phase comparator changes and AFC operates.	
13	Horizontal oscillating resistor pin		Horizontal free-oscillation frequency determining resistor.	
14	Horizontal AFC output		A pulse waveform synchronized with a horizontal oscillation waveform is output.	

■ Supplementary Explanation

• Instructions for Using IC

1. Horizontal free-oscillation frequency adjusting method

The frequency of Pin⑬ should essentially be adjusted to 15.75kHz by the counter, changing the resistor of Pin⑭ at no signal input. But this causes the voltage of Pin⑫ (AFC detecting pin) to be about 2V when a signal is input. Because supply voltage is 5V (typ.), it is desirable to use a digital voltmeter so that the voltage of Pin⑫ may be 2.5V, considering dispersion, etc.

2. External constant of Pin⑬

The following value is recommended to take in the dispersion of horizontal free-oscillation frequency of IC.

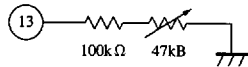

3. Vertical oscillating R.C.

High-precision parts should be used for the grounding resistor of Pin⑥ and grounding capacitor of Pin⑦ which determine vertical free-oscillation frequency. Because of 54Hz (typ.) at $C_7=0.1\mu\text{F}$ and $R_6=30\text{k}\Omega$, the value of R_6 is desirable to be 33 to 36kΩ, considering the dispersion and temperature characteristics of IC in order not to be out of vertical synchronization.

4. Power filter

It is recommended to use the following filter for power pins of Pins② and ⑩, to prevent from being out of vertical synchronization and horizontal noise. C2 of good temperature characteristics should be used.

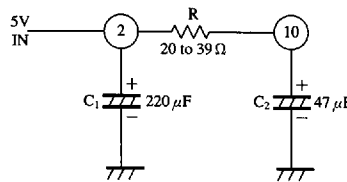

ICs for Video Camera

• Characteristics Curve

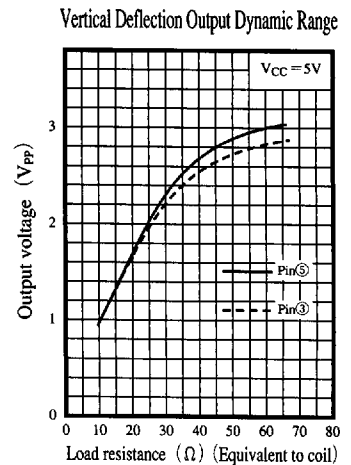
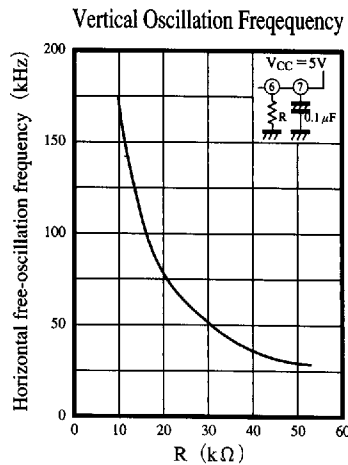
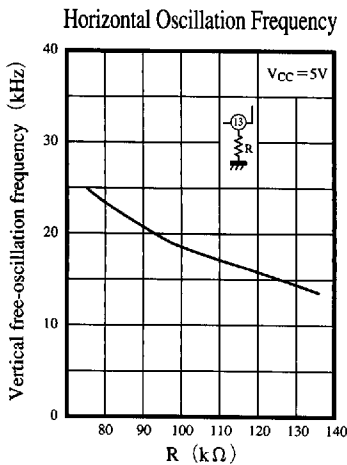

6932852 0014682 T14