



COLOR MONITOR

SyncMaster 770TFT

SERVICE *Manual*

COLOR MONITOR

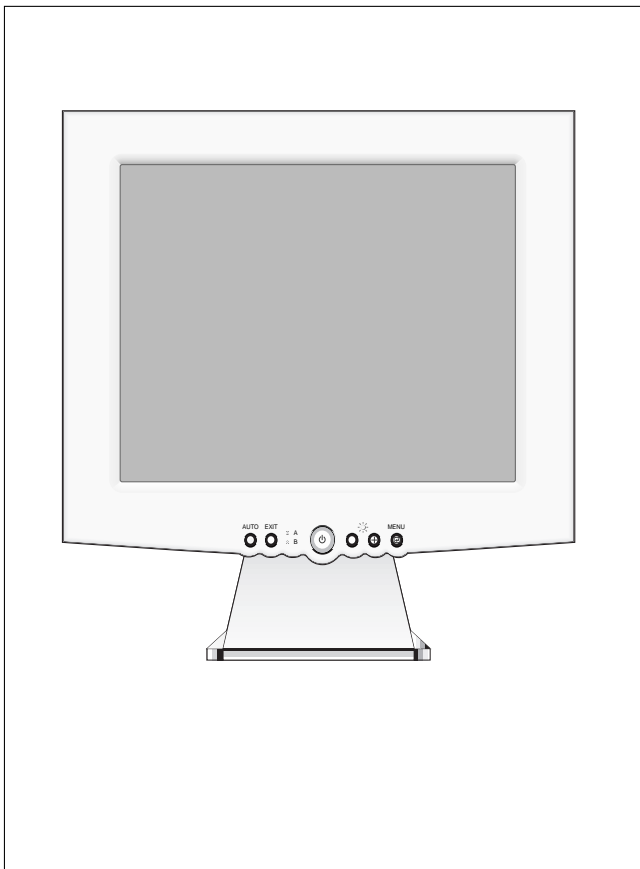

CONTENTS

1. Precautions
2. Product Specifications
3. Disassembly & Reassembly
4. Alignments & Adjustments
5. Troubleshooting
6. Exploded View & Parts List
7. Electrical Parts List
8. Block Diagram
9. Wiring Diagram
10. Schematic Diagrams



Samsung Electronics Co., Ltd. September 1999
Printed in Korea
Code No.: BN68-00097A

1 Precautions

Follow these safety, servicing and ESD precautions to prevent damage and to protect against potential hazards such as electrical shock.

1-1 Safety Precautions

1-1-1 Warnings

1. For continued safety, do not attempt to modify the circuit board.
2. Disconnect the AC power and DC power jack before servicing.

1-1-2 Servicing the LCD Monitor

1. When servicing the LCD Monitor, Disconnect the AC line cord from the AC outlet.
2. It is essential that service technicians have an accurate voltage meter available at all times. Check the calibration of this meter periodically.

1-1-3 Fire and Shock Hazard

Before returning the monitor to the user, perform the following safety checks:

1. Inspect each lead dress to make certain that the leads are not pinched or that hardware is not lodged between the chassis and other metal parts in the monitor.
2. Inspect all protective devices such as nonmetallic control knobs, insulating materials, cabinet backs, adjustment and compartment covers or shields, isolation resistor-capacitor networks, mechanical insulators, etc.
3. Leakage Current Hot Check (Figure 1-1): **WARNING: Do not use an isolation transformer during this test.** Use a leakage current tester or a metering system that complies with American National Standards Institute (*ANSI C101.1, Leakage Current for Appliances*), and Underwriters Laboratories (*UL Publication UL1410, 59.7*).

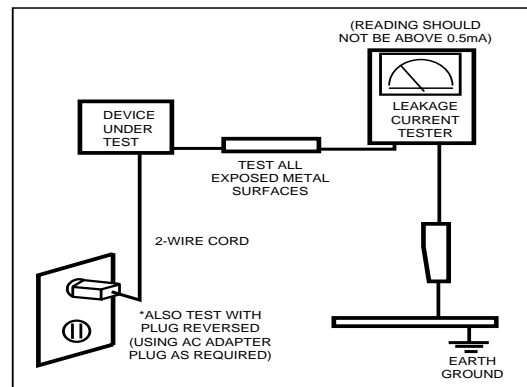

Figure 1-1. Leakage Current Test Circuit

4. With the unit completely reassembled, plug the AC line cord directly into a 120V AC outlet. With the unit's AC switch first in the ON position and then OFF, measure the current between a known earth ground (metal water pipe, conduit, etc.) and all exposed metal parts, including: metal cabinets, screwheads and control shafts. The current measured should not exceed 0.5 milliamp. Reverse the power-plug prongs in the AC outlet and repeat the test.

1-1-4 Product Safety Notices

Some electrical and mechanical parts have special safety-related characteristics which are often not evident from visual inspection. The protection they give may not be obtained by replacing them with components rated for higher voltage, wattage, etc. Parts that have special safety characteristics are identified by \triangle on schematics and parts lists. A substitute replacement that does not have the same safety characteristics as the recommended replacement part might create shock, fire and / or other hazards. Product safety is under review continuously and new instructions are issued whenever appropriate.

1-2 Servicing Precautions

WARNING: An electrolytic capacitor installed with the wrong polarity might explode.

Caution: Before servicing units covered by this service manual, read and follow the Safety Precautions section of this manual.

Note: If unforeseen circumstances create conflict between the following servicing precautions and any of the safety precautions, always follow the safety precautions.

1-2-1 General Servicing Precautions

1. Always unplug the unit's AC power cord from the AC power source and disconnect the DC Power Jack before attempting to:
 - (a) remove or reinstall any component or assembly,
 - (b) disconnect PCB plugs or connectors, (c) connect a test component in parallel with an electrolytic capacitor.
2. Some components are raised above the printed circuit board for safety. An insulation tube or tape is sometimes used. The internal wiring is sometimes clamped to prevent contact with thermally hot components. Reinstall all such elements to their original position.
3. After servicing, always check that the screws, components and wiring have been correctly reinstalled. Make sure that the area around the serviced part has not been damaged.
4. Check the insulation between the blades of the AC plug and accessible conductive parts (examples: metal panels, input terminals and earphone jacks).
5. Insulation Checking Procedure: Disconnect the power cord from the AC source and turn the power switch ON. Connect an insulation resistance meter (500 V) to the blades of the AC plug.

The insulation resistance between each blade of the AC plug and accessible conductive parts (see above) should be greater than 1 megohm.
6. Always connect a test instrument's ground lead to the instrument chassis ground *before* connecting the positive lead; always remove the instrument's ground lead last.

1-3 Electrostatically Sensitive Devices (ESD) Precautions

Some semiconductor (solid state) devices can be easily damaged by static electricity. Such components are commonly called Electrostatically Sensitive Devices (ESD). Examples of typical ESD devices are integrated circuits and some field-effect transistors. The following techniques will reduce the incidence of component damage caused by static electricity.

1. Immediately before handling any semiconductor components or assemblies, drain the electrostatic charge from your body by touching a known earth ground. Alternatively, wear a discharging wrist-strap device. To avoid a shock hazard, be sure to remove the wrist strap before applying power to the monitor.
2. After removing an ESD-equipped assembly, place it on a conductive surface such as aluminum foil to prevent accumulation of an electrostatic charge.
3. Do not use freon-propelled chemicals. These can generate electrical charges sufficient to damage ESDs.
4. Use only a grounded-tip soldering iron to solder or desolder ESDs.
5. Use only an anti-static solder removal device. Some solder removal devices not classified as "anti-static" can generate electrical charges sufficient to damage ESDs.
6. Do not remove a replacement ESD from its protective package until you are ready to install it. Most replacement ESDs are packaged with leads that are electrically shorted together by conductive foam, aluminum foil or other conductive materials.
7. Immediately before removing the protective material from the leads of a replacement ESD, touch the protective material to the chassis or circuit assembly into which the device will be installed.

Caution: Be sure no power is applied to the chassis or circuit and observe all other safety precautions.
8. Minimize body motions when handling unpackaged replacement ESDs. Motions such as brushing clothes together, or lifting your foot from a carpeted floor can generate enough static electricity to damage an ESD.

2 Product Specifications

2-1 Specifications

Item	Description
LCD Panel	TFT-LCD panel, RGB vertical stripe, normally black transmissive, 17-Inch viewable, 0.264 (H) x 0.264 (V) mm pixel pitch
Scanning Frequency	Horizontal : 30 kHz to 81 kHz (Automatic) Vertical : 56 Hz to 85 Hz (~XGA), 76 Hz (SXGA)
Display Colors	16,7 Million colors
Maximum Resolution	Horizontal : 1280 Pixels @ 81 kHz Vertical : 1024 Pixels @ 76 Hz
Input Video Signal	Analog, 0.714 Vp-p \pm 5% positive at 75 Ω , internally terminated
Input Sync Signal	Type: Separate H/V sync, Composite H/V, Sync-on-Green Level: TTL level (V high \geq 2.0 V, V low \leq 0.8 V), Sync-on-Green (\leq -0.25 V)
Maximum Pixel Clock rate	135 MHz
Active Display Horizontal/Vertical	338 \pm 3 mm / 270 \pm 3 mm
AC power voltage & Frequency	AC 90 to 264 Volts, 60/50 Hz \pm 3 Hz
Power Consumption	42 W (max.), 40W (normal)
Dimensions Unit (W x D x H) Carton (W x D x H)	17.32 x 7.16 x 18.19 Inches (440 x 182 x 462 mm) 22.91 x 22.51 x 12.48 Inches (582 x 572 x 317 mm)
Weight (Net/Gross)	8.4 kg (18.51 lbs) / 10.8 kg (23.80 lbs)
Environmental Considerations	Operating Temperature : 50°F to 104°F (10°C to 35°C) Humidity : 10 % to 80 % Storage Temperature : -68°F to 113°F (-20°C to 45°C) Humidity : 5 % to 95 %
<ul style="list-style-type: none"> • SyncMaster 770TFT comply with SWEDAC (MPR II) recommendations for reduced electromagnetic fields. • Designs and specifications are subject to change without prior notice. 	

2-2 Pin Assignments

Pin No.	Sync Type	15-Pin D-Sub & 13W3 Signal Cable Connector			
		13W3	Separate	Composite	Sync-on-green
1		A1	Red	Red	Red
2		A2	Green	Green	Green + H/V Sync
3		A3	Blue	Blue	Blue
4		4	GND	GND	GND
5		4	DDC Return (GND)	DDC Return (GND)	DDC Return (GND)
6		A1-GND	GND-R	GND-R	GND-R
7		A2-GND	GND-G	GND-G	GND-G
8		A3-GND	GND-B	GND-B	GND-B
9		3, 8	No Connection	No Connection	No Connection
10		10	Self Raster	Self Raster	Self Raster
11		4	GND	GND	GND
12		6	Bi-Dr Data (SDA)	Bi-Dr Data (SDA)	Bi-Dr Data (SDA)
13		5	H-Sync	H/V-Sync	Not Used
14		7	V-Sync	Not Used	Not Used
15		1, 2	DDC Clock (SCL)	DDC Clock (SCL)	DDC Clock (SCL)

2-3 Timing Chart

This section of the service manual describes the timing that the computer industry recognizes as standard for computer-generated video signals.

Table 2-1. Timing Chart

Mode Timing	IBM		VESA								
	VGA2/ 70 Hz 720 x 400	VGA3/ 60 Hz 640 x 480	640/75 Hz 640 x 480	640/85 Hz 640 x 480	800/75 Hz 800 x 600	800/85 Hz 800 x 600	1024/60Hz 1024 x 768	1024/75Hz 1024 x 768	1024/85Hz 1024x768	1280/76Hz 1280x1024	1280/75Hz 1280x1024
fH (kHz)	31.469	31.469	37.500	43.269	46.875	53.674	48.363	60.023	68.677	81.129	79.976
A μsec	31.777	31.778	26.667	23.111	21.333	18.631	20.677	16.660	14.561	16.640	12.504
B μsec	3.813	3.813	2.032	1.556	1.616	1.138	2.092	1.219	1.016	6.400	1.067
C μsec	1.589	1.589	3.810	2.222	3.232	2.702	2.462	2.235	2.201	2.880	1.837
D μsec	26.058	26.058	20.317	17.778	16.162	14.222	15.754	13.003	10.836		9.481
E μsec	0.318	0.318	0.508	1.556	0.323	0.569	0.369	0.203	0.508	3.200	0.119
fV (Hz)	70.087	59.940	75.000	85.008	75.000	85.061	60.004	75.029	84.997	76.106	75.025
O msec	14.268	16.683	13.333	11.764	13.333	11.756	16.666	13.328	11.765	10.660	13.329
P msec	0.064	0.064	0.080	0.671	0.064	0.056	0.124	0.050	0.044	0.080	0.038
Q msec	0.858	0.794	0.427	0.578	0.448	0.503	0.600	0.466	0.524	3.200	0.475
R msec	13.155	15.761	12.800	11.093	12.800	11.179	15.880	12.795	11.183		12.804
S msec	0.191	0.064	0.027	0.023	0.021	0.019	0.062	0.017	0.015	0.020	0.013
Clock Freq. (MHz)	28.322	25.175	31.500	49.500	49.500	56.250	75.000	78.750	94.500	135.000	135.000
Polarity H.Sync	Negative	Negative	Negative	Negative	Positive	Positive	Negative	Positive	Positive	Negative	Positive
V.Sync	Positive	Negative	Negative	Negative	Positive	Positive	Negative	Positive	Positive	Negative	Positive
Remark	Separate	Separate	Separate	Separate	Separate	Separate	Separate	Separate	Separate	Com.	Separate

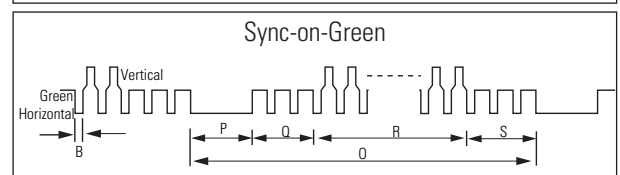
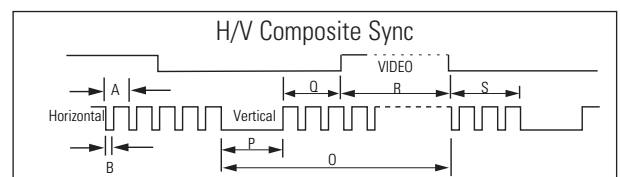
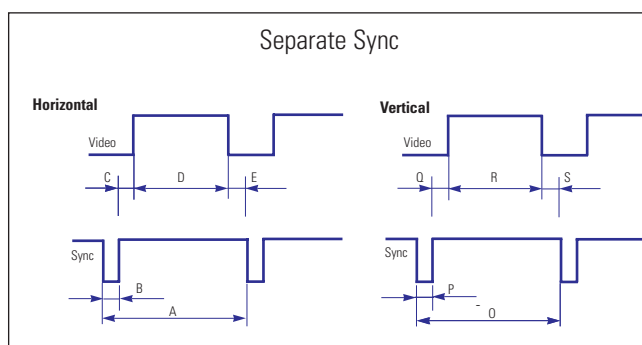

A : Line time total	B : Horizontal sync width	O : Frame time total	P : Vertical sync width
C : Back porch	D : Active time	Q : Back porch	R : Active time
E : Front porch		S : Front porch	

Memo

3 Disassembly and Reassembly

This section of the service manual describes the disassembly and reassembly procedures for the SyncMaster 770TFT TFT-LCD monitors.

WARNING: This monitor contains electrostatically sensitive devices. Use caution when handling these components.

3-1 Disassembly

- Cautions:**
1. Disconnect the monitor from the power source before disassembly.
 2. Follow these directions carefully; never use metal instruments to pry apart the cabinet.

3-1-1 Removing the Stand

1. With a pad beneath it, stand the monitor on its front with the screen facing downward and the base close to you. Make sure nothing will damage the screen.
2. Remove the 4 screws on the Stand.

Caution: Be careful. The signal cable and power cable are still attached to the monitor.

3. Disconnect the Signal Cable and Power Cord.

3-1-2 Main Body Disassembly

1. Remove 2 screws on the Rear Cover.
2. Pull the Rear Cover up and off the monitor.
3. Remove 15 screws on the PCB Shield and remove the Shield.
4. Remove 4 screws on the Main PCB and 2 screws on the Inverter PCB and 2 screws on the 10P Harness.

5. Disconnect the interface wire (31P) between the Panel and the CN601 connector on the Main PCB.
6. Disconnect the Function PCB wire (10P) between the Function PCB and the CN102 connector on the Main PCB.
7. Disconnect 2 Inverter wires between the Panel and the CN2, 3 connectors on the Inverter PCB and disconnect the 12P harness between CN1 connector on the inverter and CN103 connector on the Main PCB.
8. Carefully lift the Main PCB Assembly and Inverter PCB and place them on a flat, level surface that is protected from static electricity.
9. Remove 4 screws on the PCB Bracket.
10. Remove the Bracket Assembly from the Front Cover.
11. Remove the 3 screws on the Function PCB from the Front Cover and remove the Function PCB and Function Knob.
12. Remove 4 screws on the Front Shield and remove the PCB Bracket and the Front Shield.

3-2 Reassembly

Reassembly procedures are in the reverse order of Disassembly procedures.

Memo

4 Alignments and Adjustments

This section of the service manual explains how to use the DDC JIG to adjust the black, red, green, and blue levels of the FPD when you replace the AD Board, and how to update the microprocessor when you change the Panel or Lamp(s).

4-1 Required Equipment

The following equipment is necessary for adjusting the monitor:

- Oscilloscope with probe tool
- Computer with Windows 95[®], Windows 98[®], or Windows NT[®].
- DV17AS.exe software
- DDC Control JIG

4-2 Using the DDC Control JIG

After replacing the LCD Panel, Lamp(s), and / or AD Board, use the DDC Control JIG to complete your service. Attach the DDC Control JIG to the flat panel display (FPD) as shown in the diagrams, below.

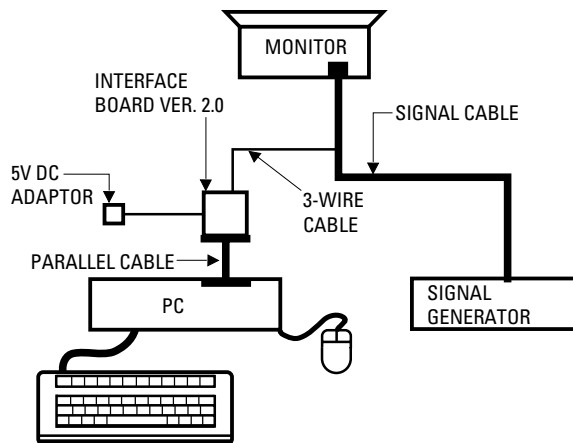

Figure 4-1. Setup 1, With Signal Generator

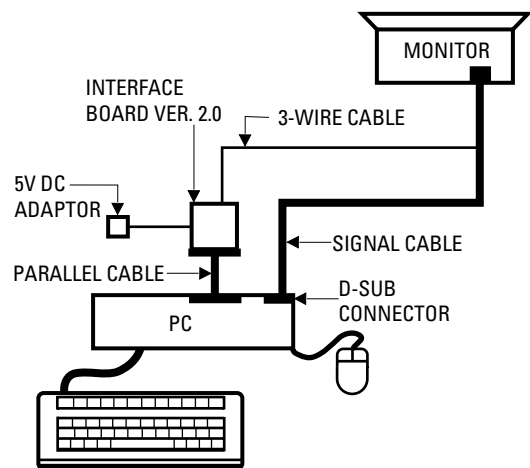

Figure 4-2. Setup 2, Without Signal Generator

4-2-1 Main Menu

4-2-1 (a) Service JIG : DV17

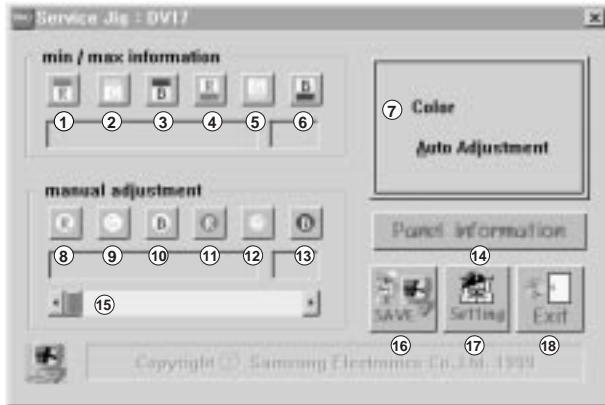

Figure 4-3. Service JIG Menu

No	Label	Definition
①	Red max value	Shows the red video signal max value
②	Green max value	Shows the green video signal max value
③	Blue max value	Shows the blue video signal max value
④	Red min value	Shows the red video signal min value
⑤	Green min value	Shows the green video signal min value
⑥	Blue min value	Shows the blue video signal min value
⑦	Color Auto Adjustment	Automatical screen contrast setting
⑧	Red gain control	Adjusts the red video signal gain control
⑨	Green gain control	Adjusts the green video signal gain control
⑩	Blue gain control	Adjusts the blue video signal gain control
⑪	Red cutoff control	Adjusts the red video signal cutoff control
⑫	Green cutoff control	Adjusts the green video signal cutoff control
⑬	Blue cutoff control	Adjusts the blue video signal cutoff control
⑭	Panel information	Shows the sub menu to panel information (4-2-2 (a))
⑮	Scroll bar	Changes the value or level of the selected item. The window to the right shows the value as it changes.
⑯	SAVE	Saves the current adjustment value of the R,G,B video contrast gain and cutoff level
⑰	Setting	Displays and allows you to adjust the PC and Control JIG communication environment. Use this button to change the Delay parameter and Port Address of your PC system and to test the connection between the Control JIG and your computer
⑱	Exit	Quits the DDC Control JIG

4-2-2 Sub Menu

4-2-2 (a) Panel Information

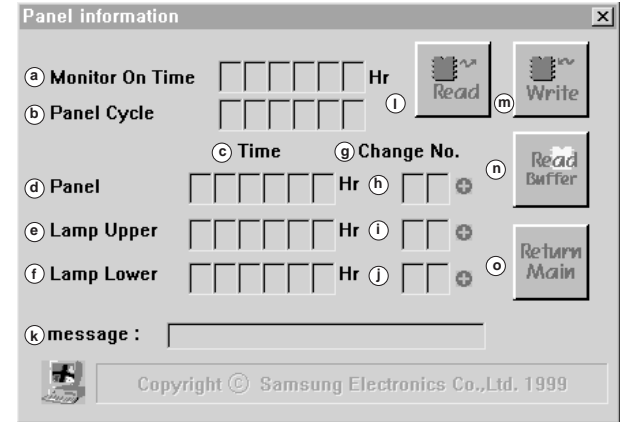

Figure 4-4. Control JIG Menu

No	Label	Definition
Ⓐ	Monitor On Time	Total hours that the monitor has been actively functioning.
Ⓑ	Panel Cycle	The total number of times the Panel has been turned ON.
Ⓒ	Time	Total in Hours that this Panel or Lamp has been ON. Reset this number to 000000 after replacing the part.
Ⓓ	Panel	Total number of hours that this Panel has been ON.
Ⓔ	Lamp, Upper	Total number of hours that this Upper Lamp has been ON.
Ⓕ	Lamp, Lower	Total number of hours that this Lower Lamp has been ON.
Ⓖ	Change No.	The number of times this Panel or Lamp has been replaced. The numbers are 00 if the item is the original factory part installed during manufacture of this monitor.
Ⓗ	Panel	Replacement times. This value is 00 if original equipment.
Ⓘ	Lamp, Upper	Replacement times. This value is 00 if original equipment.
⓫	Lamp, Lower	Replacement times. This value is 00 if original equipment.
Ⓚ	Message	Shows the message.
Ⓛ	Read	Reads all Panel information data from the AD Board
Ⓜ	Write	Writes the Panel Parameter Control values to the AD Board
Ⓝ	Read buffer	Reload the Panel Parameter Control values from the Program buffer
Ⓞ	Return Main	Returns to the Main menu

4-2-3 Adjustment Procedures

Use the following procedures whenever you replace the AD Board, Panel, or one or both of the Lamps.

4-2-3 (a) When Replacing the AD Board

1. Before replacing the AD Board, read all Panel information data by using the Read button on the DDC Control JIG.
2. Remove the old AD Board and replace it with a new board.
3. Perform the procedures described in section 4-2-3 (b).
4. Write the Panel information data to the new AD Board by using the Write button.
5. Perform other procedures using the DDC Control JIG, if necessary.
6. When all procedures are complete, select the Exit button (Ⓜ) to quit the DDC Control JIG software.

4-2-3 (b) Color Auto Adjustment

1. After displaying 16-Gray pattern or black and white mixed pattern, click “Color Auto Adjustment” button.
2. During normal execution of Auto Algorithm the screen image may flicker. If Auto Algorithm does not execute properly, check DDC Control JIG.
3. After normal execution of Auto Algorithm, confirm optimal settings by observing the contrast of several different patterns on the display.
4. If you want to check each color value, click the button from ① to ⑥ and from ⑧ to ⑬

4-2-3 (c) When Replacing the Panel

1. Select the Read Buffer button (Ⓜ) to gather the current information about this monitor.
2. Increment the number by clicking on the (+) button on the Panel row in the Change No. column. If they were not already 00, the numbers for the Upper and Lower Lamps will automatically change to 00.
3. Check all values. If there is an error, select Read Buffer again and increment the Change No. column to the correct number. When all values are correct, select the Write button (Ⓜ) to record the data in the firmware.
4. Select the Return Menu button (Ⓜ) to Return Main Menu.

4-2-3 (d) When Replacing the Upper and/or Lower Lamp

1. Select the Read Buffer button (Ⓜ) to gather current information about this monitor.
2. Increment the number by clicking on the (+) button on the Lamp Upper and/or Lamp Lower row in the Change No. column.
3. Check all values. If there is an error, select Read Buffer again and increment the Change No. column to the correct number(s). When all values are correct, select the Write button (Ⓜ) to record the data in the firmware.
4. Select the Return Menu button (Ⓜ) to Return Main Menu.

Memo

5 Troubleshooting

- Notes:**
- Before troubleshooting, setup the PC's display as below.
 - Resolution: 1280 x 1024
 - H-frequency: 64 kHz
 - V-frequency: 60 Hz
 - If no picture appears, make sure the power cord is correctly connected.
 - Check the following circuits.
 - No raster appears: Stand PCB, Main PCB
 - 14V develop but no screen: Main PCB
 - 14V does not develop: Main PCB
 - If you push and hold the EXIT button for more than 5 seconds, the monitor automatically turns back to the factory preset.

5-1 No Power

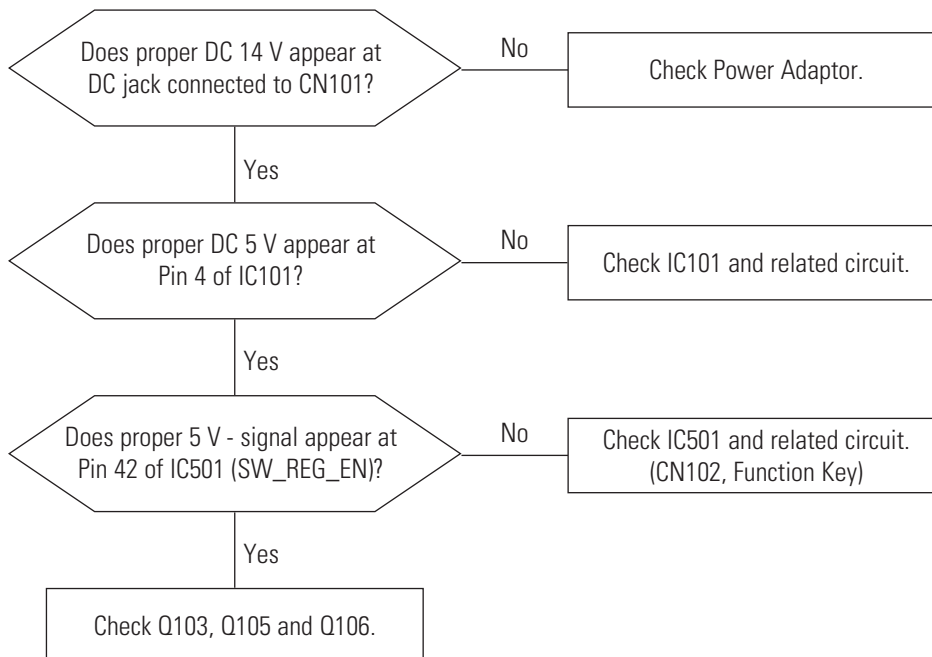

5-2 No Video

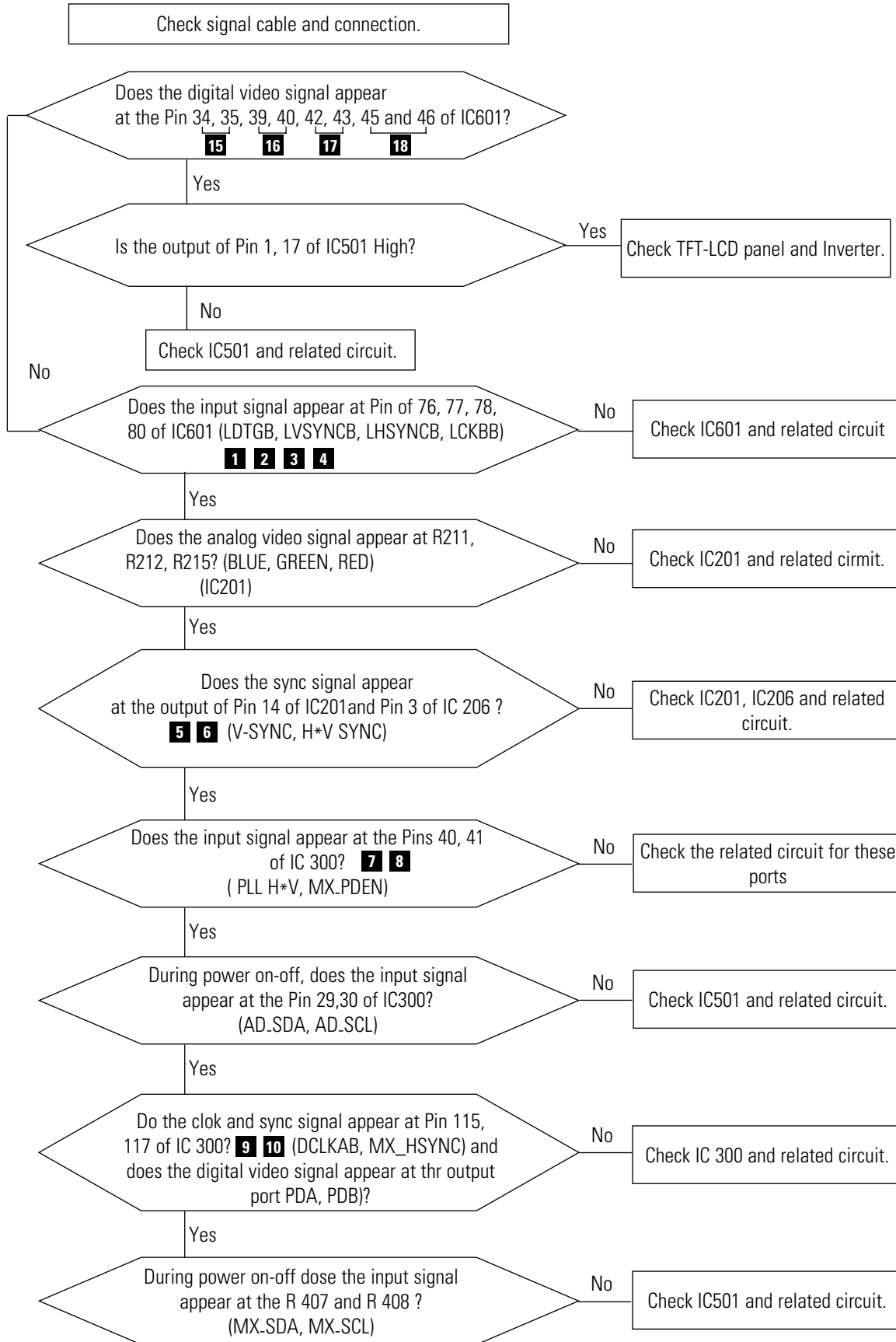

WAVEFORMS

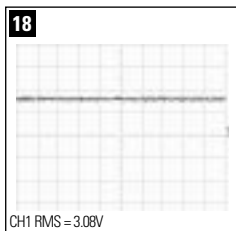
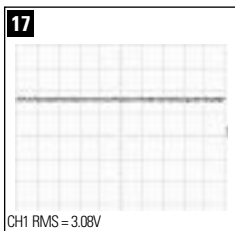
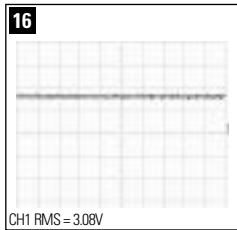
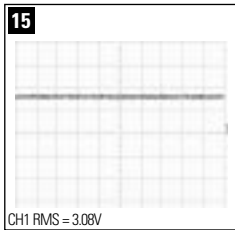
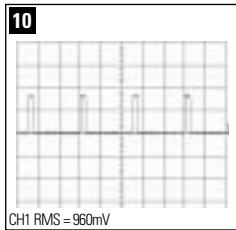
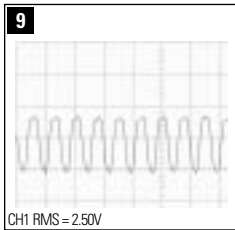
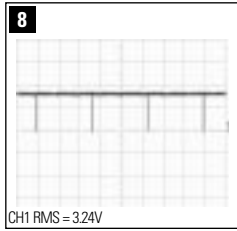
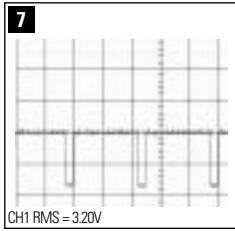
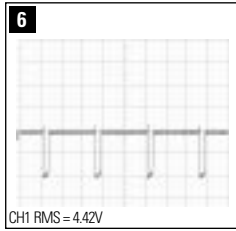
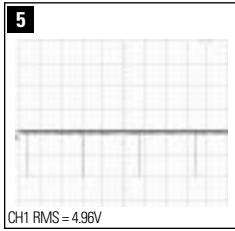
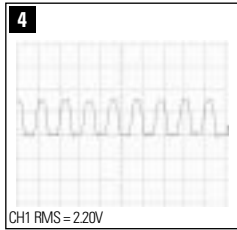
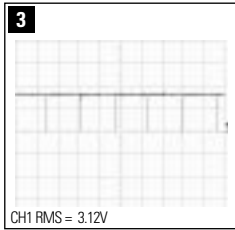
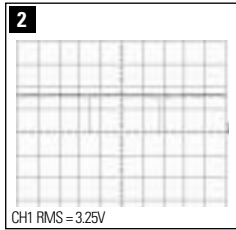
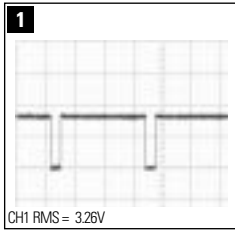

5-3 No OSD

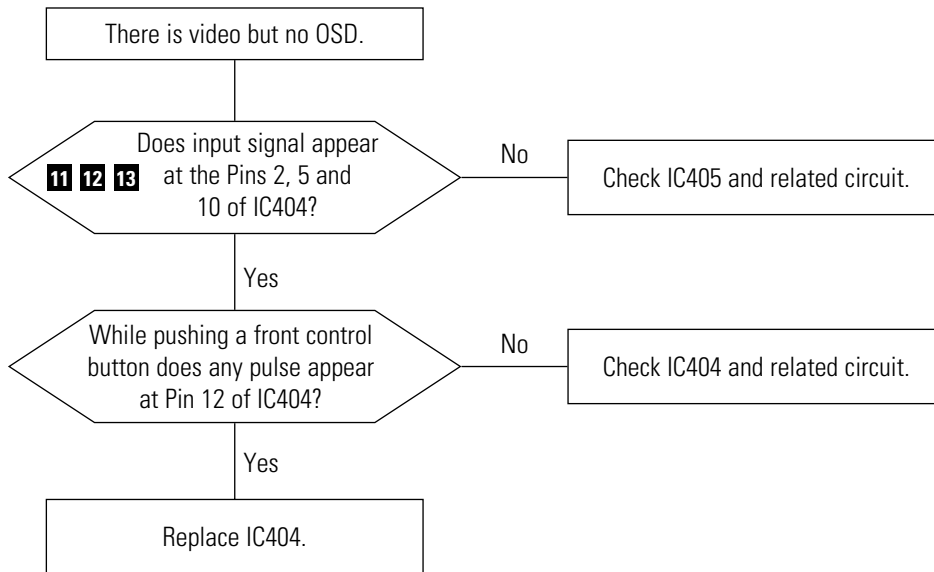

WAVEFORMS

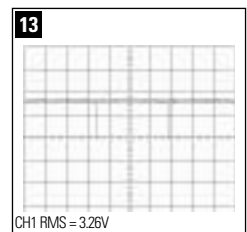
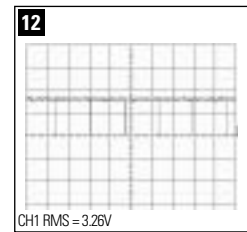
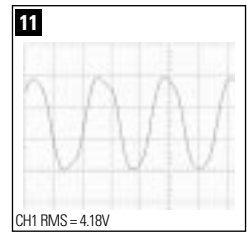

Memo

7 Electrical Parts List

7-1 Main PCB Parts

Loc. No.	Code No.	Description	Specification	Remarks
C101	2402-000176	C-AL,SMD	10uF,20%,16V,GP,TP,4.3x4.3x5.4	
C102	2203-000257	C-CERAMIC,CHIP	10nF,10%,50V,X7R,TP,1608	
C103	2203-000257	C-CERAMIC,CHIP	10nF,10%,50V,X7R,TP,1608	
C104	2402-001044	C-AL,SMD	100uF,20%,25V,TP,8.3x8.3x6.3	
C105	2404-001075	C-TA,CHIP	100uF,20%,16V,GP,TP,7343	
C106	2203-005005	C-CERAMIC,CHIP	100nF,15%,16V,W5R,TP,1608,1.6m	
C108	2404-001075	C-TA,CHIP	100uF,20%,16V,GP,TP,7343	
C109	2409-000124	C-ORGANIC	100uF,10%,16V,LZ,BK,8x10.5	
C110	2203-000257	C-CERAMIC,CHIP	10nF,10%,50V,X7R,TP,1608	
C111	2203-000257	C-CERAMIC,CHIP	10nF,10%,50V,X7R,TP,1608	
C118	2203-000257	C-CERAMIC,CHIP	10nF,10%,50V,X7R,TP,1608	
C119	2203-000257	C-CERAMIC,CHIP	10nF,10%,50V,X7R,TP,1608	
C120	2402-001044	C-AL,SMD	100uF,20%,25V,TP,8.3x8.3x6.3	
C121	2404-001075	C-TA,CHIP	100uF,20%,16V,GP,TP,7343	
C122	2402-001042	C-AL,SMD	100uF,20%,16V,GP,TP,6.6x6.6x5.	
C123	2203-005005	C-CERAMIC,CHIP	100nF,15%,16V,W5R,TP,1608,1.6m	
C124	2402-001042	C-AL,SMD	100uF,20%,16V,GP,TP,6.6x6.6x5.	
C125	2203-005005	C-CERAMIC,CHIP	100nF,15%,16V,W5R,TP,1608,1.6m	
C126	2203-005005	C-CERAMIC,CHIP	100nF,15%,16V,W5R,TP,1608,1.6m	
C127	2203-005005	C-CERAMIC,CHIP	100nF,15%,16V,W5R,TP,1608,1.6m	
C128	2203-005005	C-CERAMIC,CHIP	100nF,15%,16V,W5R,TP,1608,1.6m	
C129	2203-005005	C-CERAMIC,CHIP	100nF,15%,16V,W5R,TP,1608,1.6m	
C130	2203-005005	C-CERAMIC,CHIP	100nF,15%,16V,W5R,TP,1608,1.6m	
C131	2203-005005	C-CERAMIC,CHIP	100nF,15%,16V,W5R,TP,1608,1.6m	
C132	2203-005005	C-CERAMIC,CHIP	100nF,15%,16V,W5R,TP,1608,1.6m	
C133	2203-005005	C-CERAMIC,CHIP	100nF,15%,16V,W5R,TP,1608,1.6m	
C135	2402-001044	C-AL,SMD	100uF,20%,25V,TP,8.3x8.3x6.3	
C136	2203-000257	C-CERAMIC,CHIP	10nF,10%,50V,X7R,TP,1608	
C137	2203-005005	C-CERAMIC,CHIP	100nF,15%,16V,W5R,TP,1608,1.6m	
C150	2404-000123	C-TA,CHIP	10uF,20%,16V,6032,2.9mm,TP	
C201	2203-000257	C-CERAMIC,CHIP	10nF,10%,50V,X7R,TP,1608	
C202	2402-000176	C-AL,SMD	10uF,20%,16V,GP,TP,4.3x4.3x5.4	
C203	2203-000257	C-CERAMIC,CHIP	10nF,10%,50V,X7R,TP,1608	
C204	2402-000176	C-AL,SMD	10uF,20%,16V,GP,TP,4.3x4.3x5.4	
C205	2203-001656	C-CERAMIC,CHIP	470pF,5%,50V,CH,TP,1608,1.6mm	
C207	2402-000176	C-AL,SMD	10uF,20%,16V,GP,TP,4.3x4.3x5.4	
C208	2203-000257	C-CERAMIC,CHIP	10nF,10%,50V,X7R,TP,1608	
C209	2203-000257	C-CERAMIC,CHIP	10nF,10%,50V,X7R,TP,1608	
C210	2402-000176	C-AL,SMD	10uF,20%,16V,GP,TP,4.3x4.3x5.4	
C211	2203-005005	C-CERAMIC,CHIP	100nF,15%,16V,W5R,TP,1608,1.6m	
C213	2402-000176	C-AL,SMD	10uF,20%,16V,GP,TP,4.3x4.3x5.4	
C214	2203-000257	C-CERAMIC,CHIP	10nF,10%,50V,X7R,TP,1608	
C217	2402-000176	C-AL,SMD	10uF,20%,16V,GP,TP,4.3x4.3x5.4	
C218	2203-000257	C-CERAMIC,CHIP	10nF,10%,50V,X7R,TP,1608	
C219	2402-000176	C-AL,SMD	10uF,20%,16V,GP,TP,4.3x4.3x5.4	

7 Electrical Parts List

Loc. No.	Code No.	Description	Specification	Remarks
C222	2203-000257	C-CERAMIC,CHIP	10nF,10%,50V,X7R,TP,1608	
C223	2402-000176	C-AL,SMD	10uF,20%,16V,GP,TP,4.3x4.3x5.4	
C226	2203-005005	C-CERAMIC,CHIP	100nF,15%,16V,W5R,TP,1608,1.6m	
C230	2203-005005	C-CERAMIC,CHIP	100nF,15%,16V,W5R,TP,1608,1.6m	
C232	2203-001607	C-CERAMIC,CHIP	220pF,5%,50V,CH,TP,1608,1.6mm	
C233	2203-000998	C-CERAMIC,CHIP	47pF,5%,50V,NPO,TP,1608	
C234	2203-001607	C-CERAMIC,CHIP	220pF,5%,50V,CH,TP,1608,1.6mm	
C235	2203-005005	C-CERAMIC,CHIP	100nF,15%,16V,W5R,TP,1608,1.6m	
C236	2203-001607	C-CERAMIC,CHIP	220pF,5%,50V,CH,TP,1608,1.6mm	
C238	2203-001607	C-CERAMIC,CHIP	220pF,5%,50V,CH,TP,1608,1.6mm	
C239	2203-000998	C-CERAMIC,CHIP	47pF,5%,50V,NPO,TP,1608	
C240	2203-001607	C-CERAMIC,CHIP	220pF,5%,50V,CH,TP,1608,1.6mm	
C241	2203-001607	C-CERAMIC,CHIP	220pF,5%,50V,CH,TP,1608,1.6mm	
C242	2203-001607	C-CERAMIC,CHIP	220pF,5%,50V,CH,TP,1608,1.6mm	
C243	2402-000176	C-AL,SMD	10uF,20%,16V,GP,TP,4.3x4.3x5.4	
C244	2203-001607	C-CERAMIC,CHIP	220pF,5%,50V,CH,TP,1608,1.6mm	
C245	2402-000176	C-AL,SMD	10uF,20%,16V,GP,TP,4.3x4.3x5.4	
C246	2203-000257	C-CERAMIC,CHIP	10nF,10%,50V,X7R,TP,1608	
C247	2203-000257	C-CERAMIC,CHIP	10nF,10%,50V,X7R,TP,1608	
C248	2402-000176	C-AL,SMD	10uF,20%,16V,GP,TP,4.3x4.3x5.4	
C249	2203-005005	C-CERAMIC,CHIP	100nF,15%,16V,W5R,TP,1608,1.6m	
C301	2203-005005	C-CERAMIC,CHIP	100nF,15%,16V,W5R,TP,1608,1.6m	
C302	2203-005005	C-CERAMIC,CHIP	100nF,15%,16V,W5R,TP,1608,1.6m	
C303	2203-005005	C-CERAMIC,CHIP	100nF,15%,16V,W5R,TP,1608,1.6m	
C304	2203-005005	C-CERAMIC,CHIP	100nF,15%,16V,W5R,TP,1608,1.6m	
C305	2203-005005	C-CERAMIC,CHIP	100nF,15%,16V,W5R,TP,1608,1.6m	
C306	2203-005005	C-CERAMIC,CHIP	100nF,15%,16V,W5R,TP,1608,1.6m	
C307	2203-005005	C-CERAMIC,CHIP	100nF,15%,16V,W5R,TP,1608,1.6m	
C308	2203-005005	C-CERAMIC,CHIP	100nF,15%,16V,W5R,TP,1608,1.6m	
C309	2203-005005	C-CERAMIC,CHIP	100nF,15%,16V,W5R,TP,1608,1.6m	
C310	2203-005005	C-CERAMIC,CHIP	100nF,15%,16V,W5R,TP,1608,1.6m	
C311	2203-005005	C-CERAMIC,CHIP	100nF,15%,16V,W5R,TP,1608,1.6m	
C312	2203-005005	C-CERAMIC,CHIP	100nF,15%,16V,W5R,TP,1608,1.6m	
C313	2203-005005	C-CERAMIC,CHIP	100nF,15%,16V,W5R,TP,1608,1.6m	
C314	2203-005005	C-CERAMIC,CHIP	100nF,15%,16V,W5R,TP,1608,1.6m	
C315	2203-005005	C-CERAMIC,CHIP	100nF,15%,16V,W5R,TP,1608,1.6m	
C316	2203-005005	C-CERAMIC,CHIP	100nF,15%,16V,W5R,TP,1608,1.6m	
C317	2203-005005	C-CERAMIC,CHIP	100nF,15%,16V,W5R,TP,1608,1.6m	
C318	2203-005005	C-CERAMIC,CHIP	100nF,15%,16V,W5R,TP,1608,1.6m	
C319	2203-005005	C-CERAMIC,CHIP	100nF,15%,16V,W5R,TP,1608,1.6m	
C320	2203-005005	C-CERAMIC,CHIP	100nF,15%,16V,W5R,TP,1608,1.6m	
C321	2203-005005	C-CERAMIC,CHIP	100nF,15%,16V,W5R,TP,1608,1.6m	
C322	2203-005005	C-CERAMIC,CHIP	100nF,15%,16V,W5R,TP,1608,1.6m	
C323	2203-005005	C-CERAMIC,CHIP	100nF,15%,16V,W5R,TP,1608,1.6m	
C324	2203-005005	C-CERAMIC,CHIP	100nF,15%,16V,W5R,TP,1608,1.6m	
C325	2203-005005	C-CERAMIC,CHIP	100nF,15%,16V,W5R,TP,1608,1.6m	
C326	2203-005005	C-CERAMIC,CHIP	100nF,15%,16V,W5R,TP,1608,1.6m	

Loc. No.	Code No.	Description	Specification	Remarks
C327	2203-000257	C-CERAMIC,CHIP	10nF,10%,50V,X7R,TP,1608	
C328	2203-000257	C-CERAMIC,CHIP	10nF,10%,50V,X7R,TP,1608	
C329	2203-000257	C-CERAMIC,CHIP	10nF,10%,50V,X7R,TP,1608	
C330	2203-000257	C-CERAMIC,CHIP	10nF,10%,50V,X7R,TP,1608	
C332	2203-005005	C-CERAMIC,CHIP	100nF,15%,16V,W5R,TP,1608,1.6m	
C333	2402-000176	C-AL,SMD	10uF,20%,16V,GP,TP,4.3x4.3x5.4	
C334	2402-000176	C-AL,SMD	10uF,20%,16V,GP,TP,4.3x4.3x5.4	
C335	2402-000176	C-AL,SMD	10uF,20%,16V,GP,TP,4.3x4.3x5.4	
C354	2203-000384	C-CERAMIC,CHIP	15pF,5%,50V,NPO,TP,1608	
C355	2203-000384	C-CERAMIC,CHIP	15pF,5%,50V,NPO,TP,1608	
C356	2203-000384	C-CERAMIC,CHIP	15pF,5%,50V,NPO,TP,1608	
C357	2203-000257	C-CERAMIC,CHIP	10nF,10%,50V,X7R,TP,1608	
C401	2203-005005	C-CERAMIC,CHIP	100nF,15%,16V,W5R,TP,1608,1.6m	
C402	2203-005005	C-CERAMIC,CHIP	100nF,15%,16V,W5R,TP,1608,1.6m	
C403	2203-005005	C-CERAMIC,CHIP	100nF,15%,16V,W5R,TP,1608,1.6m	
C404	2203-005005	C-CERAMIC,CHIP	100nF,15%,16V,W5R,TP,1608,1.6m	
C405	2203-005005	C-CERAMIC,CHIP	100nF,15%,16V,W5R,TP,1608,1.6m	
C406	2203-005005	C-CERAMIC,CHIP	100nF,15%,16V,W5R,TP,1608,1.6m	
C407	2203-005005	C-CERAMIC,CHIP	100nF,15%,16V,W5R,TP,1608,1.6m	
C408	2203-005005	C-CERAMIC,CHIP	100nF,15%,16V,W5R,TP,1608,1.6m	
C409	2203-005005	C-CERAMIC,CHIP	100nF,15%,16V,W5R,TP,1608,1.6m	
C410	2203-005005	C-CERAMIC,CHIP	100nF,15%,16V,W5R,TP,1608,1.6m	
C411	2203-005005	C-CERAMIC,CHIP	100nF,15%,16V,W5R,TP,1608,1.6m	
C412	2203-005005	C-CERAMIC,CHIP	100nF,15%,16V,W5R,TP,1608,1.6m	
C413	2203-005005	C-CERAMIC,CHIP	100nF,15%,16V,W5R,TP,1608,1.6m	
C414	2203-005005	C-CERAMIC,CHIP	100nF,15%,16V,W5R,TP,1608,1.6m	
C415	2203-005005	C-CERAMIC,CHIP	100nF,15%,16V,W5R,TP,1608,1.6m	
C416	2203-005005	C-CERAMIC,CHIP	100nF,15%,16V,W5R,TP,1608,1.6m	
C417	2203-005005	C-CERAMIC,CHIP	100nF,15%,16V,W5R,TP,1608,1.6m	
C418	2203-005005	C-CERAMIC,CHIP	100nF,15%,16V,W5R,TP,1608,1.6m	
C419	2203-005005	C-CERAMIC,CHIP	100nF,15%,16V,W5R,TP,1608,1.6m	
C420	2404-000123	C-TA,CHIP	10uF,20%,16V,6032,2.9mm,TP	
C421	2203-000384	C-CERAMIC,CHIP	15pF,5%,50V,NPO,TP,1608	
C422	2203-005005	C-CERAMIC,CHIP	100nF,15%,16V,W5R,TP,1608,1.6m	
C423	2203-000292	C-CERAMIC,CHIP	10pF,5%,50V,NPO,TP,1608	
C424	2203-005005	C-CERAMIC,CHIP	100nF,15%,16V,W5R,TP,1608,1.6m	
C425	2203-005005	C-CERAMIC,CHIP	100nF,15%,16V,W5R,TP,1608,1.6m	
C426	2203-005005	C-CERAMIC,CHIP	100nF,15%,16V,W5R,TP,1608,1.6m	
C427	2203-005005	C-CERAMIC,CHIP	100nF,15%,16V,W5R,TP,1608,1.6m	
C428	2402-000176	C-AL,SMD	10uF,20%,16V,GP,TP,4.3x4.3x5.4	
C429	2203-005005	C-CERAMIC,CHIP	100nF,15%,16V,W5R,TP,1608,1.6m	
C430	2203-000292	C-CERAMIC,CHIP	10pF,5%,50V,NPO,TP,1608	
C431	2404-000123	C-TA,CHIP	10uF,20%,16V,6032,2.9mm,TP	
C432	2203-005005	C-CERAMIC,CHIP	100nF,15%,16V,W5R,TP,1608,1.6m	
C433	2203-005005	C-CERAMIC,CHIP	100nF,15%,16V,W5R,TP,1608,1.6m	
C434	2203-005005	C-CERAMIC,CHIP	100nF,15%,16V,W5R,TP,1608,1.6m	
C435	2203-000384	C-CERAMIC,CHIP	15pF,5%,50V,NPO,TP,1608	

7 Electrical Parts List

Loc. No.	Code No.	Description	Specification	Remarks
C436	2203-000292	C-CERAMIC,CHIP	10pF,5%,50V,NPO,TP,1608	
C437	2203-000292	C-CERAMIC,CHIP	10pF,5%,50V,NPO,TP,1608	
C438	2203-000292	C-CERAMIC,CHIP	10pF,5%,50V,NPO,TP,1608	
C439	2203-000292	C-CERAMIC,CHIP	10pF,5%,50V,NPO,TP,1608	
C440	2203-005005	C-CERAMIC,CHIP	100nF,15%,16V,W5R,TP,1608,1.6m	
C441	2402-000176	C-AL,SMD	10uF,20%,16V,GP,TP,4.3x4.3x5.4	
C442	2203-005005	C-CERAMIC,CHIP	100nF,15%,16V,W5R,TP,1608,1.6m	
C443	2203-005005	C-CERAMIC,CHIP	100nF,15%,16V,W5R,TP,1608,1.6m	
C444	2203-005005	C-CERAMIC,CHIP	100nF,15%,16V,W5R,TP,1608,1.6m	
C445	2203-005005	C-CERAMIC,CHIP	100nF,15%,16V,W5R,TP,1608,1.6m	
C446	2203-005005	C-CERAMIC,CHIP	100nF,15%,16V,W5R,TP,1608,1.6m	
C448	2203-005005	C-CERAMIC,CHIP	100nF,15%,16V,W5R,TP,1608,1.6m	
C449	2203-005005	C-CERAMIC,CHIP	100nF,15%,16V,W5R,TP,1608,1.6m	
C450	2203-005005	C-CERAMIC,CHIP	100nF,15%,16V,W5R,TP,1608,1.6m	
C451	2203-000626	C-CERAMIC,CHIP	22pF,5%,50V,NPO,TP,1608	
C452	2402-000176	C-AL,SMD	10uF,20%,16V,GP,TP,4.3x4.3x5.4	
C453	2203-000626	C-CERAMIC,CHIP	22pF,5%,50V,NPO,TP,1608	
C454	2203-005005	C-CERAMIC,CHIP	100nF,15%,16V,W5R,TP,1608,1.6m	
C455	2203-005005	C-CERAMIC,CHIP	100nF,15%,16V,W5R,TP,1608,1.6m	
C456	2402-000176	C-AL,SMD	10uF,20%,16V,GP,TP,4.3x4.3x5.4	
C457	2203-005005	C-CERAMIC,CHIP	100nF,15%,16V,W5R,TP,1608,1.6m	
C458	2402-001042	C-AL,SMD	100uF,20%,16V,GP,TP,6.6x6.6x5.	
C459	2203-005005	C-CERAMIC,CHIP	100nF,15%,16V,W5R,TP,1608,1.6m	
C460	2203-005005	C-CERAMIC,CHIP	100nF,15%,16V,W5R,TP,1608,1.6m	
C461	2203-000292	C-CERAMIC,CHIP	10pF,5%,50V,NPO,TP,1608	
C501	2203-000257	C-CERAMIC,CHIP	10nF,10%,50V,X7R,TP,1608	
C502	2203-000257	C-CERAMIC,CHIP	10nF,10%,50V,X7R,TP,1608	
C503	2402-000176	C-AL,SMD	10uF,20%,16V,GP,TP,4.3x4.3x5.4	
C504	2402-000176	C-AL,SMD	10uF,20%,16V,GP,TP,4.3x4.3x5.4	
C506	2203-000626	C-CERAMIC,CHIP	22pF,5%,50V,NPO,TP,1608	
C507	2203-000626	C-CERAMIC,CHIP	22pF,5%,50V,NPO,TP,1608	
C508	2402-000176	C-AL,SMD	10uF,20%,16V,GP,TP,4.3x4.3x5.4	
C509	2203-000257	C-CERAMIC,CHIP	10nF,10%,50V,X7R,TP,1608	
C510	2203-000236	C-CERAMIC,CHIP	100pF,5%,50V,NPO,TP,1608	
C511	2203-000236	C-CERAMIC,CHIP	100pF,5%,50V,NPO,TP,1608	
C512	2203-000257	C-CERAMIC,CHIP	10nF,10%,50V,X7R,TP,1608	
C513	2402-000176	C-AL,SMD	10uF,20%,16V,GP,TP,4.3x4.3x5.4	
C514	2203-005005	C-CERAMIC,CHIP	100nF,15%,16V,W5R,TP,1608,1.6m	
C515	2402-001042	C-AL,SMD	100uF,20%,16V,GP,TP,6.6x6.6x5.	
C516	2203-000491	C-CERAMIC,CHIP	2.2nF,10%,50V,X7R,TP,1608	
C517	2402-000176	C-AL,SMD	10uF,20%,16V,GP,TP,4.3x4.3x5.4	
C601	2404-001075	C-TA,CHIP	100uF,20%,16V,GP,TP,7343	
C602	2203-005005	C-CERAMIC,CHIP	100nF,15%,16V,W5R,TP,1608,1.6m	
C603	2203-005005	C-CERAMIC,CHIP	100nF,15%,16V,W5R,TP,1608,1.6m	
C604	2203-005005	C-CERAMIC,CHIP	100nF,15%,16V,W5R,TP,1608,1.6m	
C605	2203-005005	C-CERAMIC,CHIP	100nF,15%,16V,W5R,TP,1608,1.6m	
C607	2203-005005	C-CERAMIC,CHIP	100nF,15%,16V,W5R,TP,1608,1.6m	

Loc. No.	Code No.	Description	Specification	Remarks
C608	2203-005005	C-CERAMIC,CHIP	100nF,15%,16V,W5R,TP,1608,1.6m	
C609	2203-005005	C-CERAMIC,CHIP	100nF,15%,16V,W5R,TP,1608,1.6m	
C610	2404-000123	C-TA,CHIP	10uF,20%,16V,6032,2.9mm,TP	
C611	2203-005005	C-CERAMIC,CHIP	100nF,15%,16V,W5R,TP,1608,1.6m	
C612	2203-005005	C-CERAMIC,CHIP	100nF,15%,16V,W5R,TP,1608,1.6m	
C613	2203-005005	C-CERAMIC,CHIP	100nF,15%,16V,W5R,TP,1608,1.6m	
C614	2203-005005	C-CERAMIC,CHIP	100nF,15%,16V,W5R,TP,1608,1.6m	
C615	2203-005005	C-CERAMIC,CHIP	100nF,15%,16V,W5R,TP,1608,1.6m	
C616	2203-005005	C-CERAMIC,CHIP	100nF,15%,16V,W5R,TP,1608,1.6m	
C617	2203-005005	C-CERAMIC,CHIP	100nF,15%,16V,W5R,TP,1608,1.6m	
C618	2203-005005	C-CERAMIC,CHIP	100nF,15%,16V,W5R,TP,1608,1.6m	
C619	2404-000123	C-TA,CHIP	10uF,20%,16V,6032,2.9mm,TP	
C620	2203-005005	C-CERAMIC,CHIP	100nF,15%,16V,W5R,TP,1608,1.6m	
C621	2404-001075	C-TA,CHIP	100uF,20%,16V,GP,TP,7343	
C622	2203-005005	C-CERAMIC,CHIP	100nF,15%,16V,W5R,TP,1608,1.6m	
C623	2203-005005	C-CERAMIC,CHIP	100nF,15%,16V,W5R,TP,1608,1.6m	
C624	2203-005005	C-CERAMIC,CHIP	100nF,15%,16V,W5R,TP,1608,1.6m	
C625	2402-001042	C-AL,SMD	100uF,20%,16V,GP,TP,6.6x6.6x5.	
C626	2203-005005	C-CERAMIC,CHIP	100nF,15%,16V,W5R,TP,1608,1.6m	
CA300	2503-001018	C-NETWORK	15PFX4,10%,50V	
CA301	2503-001018	C-NETWORK	15PFX4,10%,50V	
CA302	2503-001018	C-NETWORK	15PFX4,10%,50V	
CA303	2503-001018	C-NETWORK	15PFX4,10%,50V	
CA304	2503-001018	C-NETWORK	15PFX4,10%,50V	
CA305	2503-001018	C-NETWORK	15PFX4,10%,50V	
CA306	2503-001018	C-NETWORK	15PFX4,10%,50V	
CA307	2503-001018	C-NETWORK	15PFX4,10%,50V	
CA308	2503-001018	C-NETWORK	15PFX4,10%,50V	
CA309	2503-001018	C-NETWORK	15PFX4,10%,50V	
CA310	2503-001018	C-NETWORK	15PFX4,10%,50V	
CA311	2503-001018	C-NETWORK	15PFX4,10%,50V	
CA401	2503-001018	C-NETWORK	15PFX4,10%,50V	
CA402	2503-001018	C-NETWORK	15PFX4,10%,50V	
CA403	2503-001018	C-NETWORK	15PFX4,10%,50V	
CA404	2503-001018	C-NETWORK	15PFX4,10%,50V	
CA405	2503-001018	C-NETWORK	15PFX4,10%,50V	
CA406	2503-001018	C-NETWORK	15PFX4,10%,50V	
CA407	2503-001018	C-NETWORK	15PFX4,10%,50V	
CA408	2503-001018	C-NETWORK	15PFX4,10%,50V	
CA409	2503-001018	C-NETWORK	15PFX4,10%,50V	
CA410	2503-001018	C-NETWORK	15PFX4,10%,50V	
CA411	2503-001018	C-NETWORK	15PFX4,10%,50V	
CA412	2503-001018	C-NETWORK	15PFX4,10%,50V	
CN101	3722-000117	JACK-DC POWER	3P,3.5mm,AG,BLK,NO	
CN102	3711-002050	CONNECTOR-HEADER	BOX,10P,1R,1.25mm,SMD-A,SN	
CN103	3711-000556	CONNECTOR-HEADER	BOX,12P,1R,1.25mm,SMD-A,SN	
CN201	3701-001129	CONNECTOR-DSUB	15P,3R,FEMALE,ANGLE,AUF	

7 Electrical Parts List

Loc. No.	Code No.	Description	Specification	Remarks
CN202	3701-001137	CONNECTOR-DSUB	10P+3P,2R,FEMALE,ANGLE,AUF	
CN601	3711-004130	CONNECTOR-HEADER	BOX,31P,2R,0.625mm,SMD-A,AUF	
CN602	3711-003942	CONNECTOR-HEADER	BOX,2P,1R,2mm,STRAIGHT,SN	
D3	0401-001056	DIODE-SWITCHING	MMBD4148SE,75V,600mA,SOT-23,TP	
D101	0402-001098	DIODE-RECTIFIER	SK34,40V,3.0A,SMC,TP	
D102	0402-001098	DIODE-RECTIFIER	SK34,40V,3.0A,SMC,TP	
D103	0401-001056	DIODE-SWITCHING	MMBD4148SE,75V,600mA,SOT-23,TP	
D104	0401-001056	DIODE-SWITCHING	MMBD4148SE,75V,600mA,SOT-23,TP	
D201	0401-001056	DIODE-SWITCHING	MMBD4148SE,75V,600mA,SOT-23,TP	
D202	0401-001056	DIODE-SWITCHING	MMBD4148SE,75V,600mA,SOT-23,TP	
D203	0401-001056	DIODE-SWITCHING	MMBD4148SE,75V,600mA,SOT-23,TP	
D204	0401-001056	DIODE-SWITCHING	MMBD4148SE,75V,600mA,SOT-23,TP	
D205	0401-001056	DIODE-SWITCHING	MMBD4148SE,75V,600mA,SOT-23,TP	
D206	0401-001056	DIODE-SWITCHING	MMBD4148SE,75V,600mA,SOT-23,TP	
D207	0401-001056	DIODE-SWITCHING	MMBD4148SE,75V,600mA,SOT-23,TP	
D208	0401-001056	DIODE-SWITCHING	MMBD4148SE,75V,600mA,SOT-23,TP	
D209	0401-001056	DIODE-SWITCHING	MMBD4148SE,75V,600mA,SOT-23,TP	
D211	0401-001056	DIODE-SWITCHING	MMBD4148SE,75V,600mA,SOT-23,TP	
D212	0401-001056	DIODE-SWITCHING	MMBD4148SE,75V,600mA,SOT-23,TP	
D213	0401-001056	DIODE-SWITCHING	MMBD4148SE,75V,600mA,SOT-23,TP	
D214	0401-001056	DIODE-SWITCHING	MMBD4148SE,75V,600mA,SOT-23,TP	
D215	0401-001056	DIODE-SWITCHING	MMBD4148SE,75V,600mA,SOT-23,TP	
D216	0401-001056	DIODE-SWITCHING	MMBD4148SE,75V,600mA,SOT-23,TP	
D501	0403-000579	DIODE-ZENER	BZX84C5V1,5.1V,5%,200mW,SOT-23	
FT43	2901-001114	FILTER-EMI SMD	25VDC,2.0ADC,100nF,3.2x1.6x1	
FT101	3301-001145	CORE-FERRITE BEAD	AB,4.5x1.6x1.6mm	
FT102	3301-001145	CORE-FERRITE BEAD	AB,4.5x1.6x1.6mm	
FT103	3301-001145	CORE-FERRITE BEAD	AB,4.5x1.6x1.6mm	
FT108	3301-001145	CORE-FERRITE BEAD	AB,4.5x1.6x1.6mm	
FT109	3301-001145	CORE-FERRITE BEAD	AB,4.5x1.6x1.6mm	
FT110	2901-001130	FILTER-EMI SMD	25V,4A,6.8nF,4.5x3.2x1.5,TP	
FT202	2901-001114	FILTER-EMI SMD	25VDC,2.0ADC,100nF,3.2x1.6x1	
FT203	2901-001114	FILTER-EMI SMD	25VDC,2.0ADC,100nF,3.2x1.6x1	
FT204	2901-001114	FILTER-EMI SMD	25VDC,2.0ADC,100nF,3.2x1.6x1	
FT205	2901-001114	FILTER-EMI SMD	25VDC,2.0ADC,100nF,3.2x1.6x1	
FT206	2901-001114	FILTER-EMI SMD	25VDC,2.0ADC,100nF,3.2x1.6x1	
FT301	2703-001070	INDUCTOR-SMD	100uH,10%,4.5x3.2x3.2mm	
FT302	2703-001070	INDUCTOR-SMD	100uH,10%,4.5x3.2x3.2mm	
FT401	2901-001114	FILTER-EMI SMD	25VDC,2.0ADC,100nF,3.2x1.6x1	
FT402	2901-001114	FILTER-EMI SMD	25VDC,2.0ADC,100nF,3.2x1.6x1	
FT403	2901-001114	FILTER-EMI SMD	25VDC,2.0ADC,100nF,3.2x1.6x1	
FT404	2901-001114	FILTER-EMI SMD	25VDC,2.0ADC,100nF,3.2x1.6x1	
FT406	2901-001114	FILTER-EMI SMD	25VDC,2.0ADC,100nF,3.2x1.6x1	
FT407	2901-001114	FILTER-EMI SMD	25VDC,2.0ADC,100nF,3.2x1.6x1	
FT408	2901-001114	FILTER-EMI SMD	25VDC,2.0ADC,100nF,3.2x1.6x1	
FT410	2901-001114	FILTER-EMI SMD	25VDC,2.0ADC,100nF,3.2x1.6x1	
FT411	2901-001114	FILTER-EMI SMD	25VDC,2.0ADC,100nF,3.2x1.6x1	

Loc. No.	Code No.	Description	Specification	Remarks
FT501	2901-001114	FILTER-EMI SMD	25VDC,2.0ADC,100nF,3.2x1.6x1	
FT502	2901-001114	FILTER-EMI SMD	25VDC,2.0ADC,100nF,3.2x1.6x1	
FT503	2901-001114	FILTER-EMI SMD	25VDC,2.0ADC,100nF,3.2x1.6x1	
FT601	3301-001145	CORE-FERRITE BEAD	AB,4.5x1.6x1.6mm	
FT602	2901-001114	FILTER-EMI SMD	25VDC,2.0ADC,100nF,3.2x1.6x1	
FT603	3301-001145	CORE-FERRITE BEAD	AB,4.5x1.6x1.6mm	
FT604	2901-001114	FILTER-EMI SMD	25VDC,2.0ADC,100nF,3.2x1.6x1	
FT605	2901-001114	FILTER-EMI SMD	25VDC,2.0ADC,100nF,3.2x1.6x1	
FT606	2901-001114	FILTER-EMI SMD	25VDC,2.0ADC,100nF,3.2x1.6x1	
FT607	2901-001114	FILTER-EMI SMD	25VDC,2.0ADC,100nF,3.2x1.6x1	
FT608	3301-001145	CORE-FERRITE BEAD	AB,4.5x1.6x1.6mm	
IC13	1203-001801	IC-POSI.FIXED REG.	3300,SOT-23,6P,70MIL,PLASTIC,3	
IC101	1203-001448	IC-POSI.FIXED REG.	2596,TO-263,5P,PLASTIC,4.750	
IC102	1203-001447	IC-POSI.FIXED REG.	2596,TO-263,5P,PLASTIC,3.135	
IC201	1001-001082	IC-VIDEO SWITCH	BA7657F,SOP,24P,300MIL,SINGL	
IC204	0803-000106	IC-TTL	74F132,TRIGGER,SOP,14P,150MIL	
IC205	0803-000106	IC-TTL	74F132,TRIGGER,SOP,14P,150MIL	
IC206	0803-000122	IC-TTL	74F125,BUFFER,SOP,14P,150MIL,Q	
IC207	0801-002171	IC-CMOS LOGIC	74LCX125,BUS BUFFER,SOP,14P,15	
IC208	0803-000117	IC-TTL	74F14,INVERTER,SOP,14P,150MIL,	
IC209	0801-002404	IC-CMOS LOGIC	74VHC4066,ANALOG SWITCH,SOP,14	
IC300	1002-001171	IC-A/D CONVERTER	AD9884,8BIT,QFP,128P,1/2LSB,	
IC401	1105-001165	IC-DRAM	416S1020B,2x512Kx16BIT,SOP,50P	
IC402	1105-001165	IC-DRAM	416S1020B,2x512Kx16BIT,SOP,50P	
IC403	1105-001165	IC-DRAM	416S1020B,2x512Kx16BIT,SOP,50P	
IC404	BN09-00001A	IC-OSD PROCESSOR	MTV 121P-131, 16P	
IC405	0801-002237	IC-CMOS LOGIC	74HC04,INVERTER GATE,SOP,5P,49	
IC406	1003-001243	IC-LCD CONTROLLER	MX88L282FC,QFP,256P,1102MIL,DU	
IC501	0903-001063	IC-MICROCONTROLLER	72E75,8BIT,DIP,42P,600MIL,24MH	
IC502	1103-001164	IC-EEPROM	24LC21A,128X8BIT,SOP,8P,150MIL	
IC503	1103-001163	IC-EEPROM	24LC041,512X8BIT,SOP,8P,150MIL	
IC504	1203-001109	IC-VOL. DETECTOR	7045,SOT-89,3P,PLASTIC,4.3/4	
IC601	1006-001130	IC-LINE TRANSCEIVER	150,QFP,100P,-,TR,PLASTIC,-0	
L101	2703-001778	INDUCTOR-SMD	3.3UH,20%,3.2X2.5X2.2MM	
L102	2703-001778	INDUCTOR-SMD	3.3UH,20%,3.2X2.5X2.2MM	
L103	2703-001778	INDUCTOR-SMD	3.3UH,20%,3.2X2.5X2.2MM	
L104	BN27-20001C	COIL-SMD	105UH,20%,SMD,TAPING	
L105	2703-001778	INDUCTOR-SMD	3.3UH,20%,3.2X2.5X2.2MM	
L106	2703-001778	INDUCTOR-SMD	3.3UH,20%,3.2X2.5X2.2MM	
L107	BN27-20001A	COIL-CHOKE	53.0UH,20%,DR10*5,TRAY	
L108	2703-001778	INDUCTOR-SMD	3.3UH,20%,3.2X2.5X2.2MM	
L109	2703-001334	INDUCTOR-SMD	1.5uH,10%,2x1.25x0.85mm	
L110	2703-001334	INDUCTOR-SMD	1.5uH,10%,2x1.25x0.85mm	
L111	2703-001778	INDUCTOR-SMD	3.3UH,20%,3.2X2.5X2.2MM	
L112	2703-001334	INDUCTOR-SMD	1.5uH,10%,2x1.25x0.85mm	
L113	2703-001334	INDUCTOR-SMD	1.5uH,10%,2x1.25x0.85mm	
L114	2703-001334	INDUCTOR-SMD	1.5uH,10%,2x1.25x0.85mm	

7 Electrical Parts List

Loc. No.	Code No.	Description	Specification	Remarks
L115	2703-001334	INDUCTOR-SMD	1.5uH,10%,2x1.25x0.85mm	
L116	2703-001334	INDUCTOR-SMD	1.5uH,10%,2x1.25x0.85mm	
L117	2703-001334	INDUCTOR-SMD	1.5uH,10%,2x1.25x0.85mm	
L119	2703-001334	INDUCTOR-SMD	1.5uH,10%,2x1.25x0.85mm	
L120	2703-001334	INDUCTOR-SMD	1.5uH,10%,2x1.25x0.85mm	
L121	2703-001778	INDUCTOR-SMD	3.3UH,20%,3.2X2.5X2.2MM	
L122	2703-001334	INDUCTOR-SMD	1.5uH,10%,2x1.25x0.85mm	
L123	2703-001334	INDUCTOR-SMD	1.5uH,10%,2x1.25x0.85mm	
L124	2703-001334	INDUCTOR-SMD	1.5uH,10%,2x1.25x0.85mm	
L125	2703-001334	INDUCTOR-SMD	1.5uH,10%,2x1.25x0.85mm	
L126	2703-001334	INDUCTOR-SMD	1.5uH,10%,2x1.25x0.85mm	
L127	2703-001070	INDUCTOR-SMD	100uH,10%,4.5x3.2x3.2mm	
L129	2703-001070	INDUCTOR-SMD	100uH,10%,4.5x3.2x3.2mm	
L201	2703-001070	INDUCTOR-SMD	100uH,10%,4.5x3.2x3.2mm	
L202	2703-001334	INDUCTOR-SMD	1.5uH,10%,2x1.25x0.85mm	
L203	2703-001334	INDUCTOR-SMD	1.5uH,10%,2x1.25x0.85mm	
L204	2703-001334	INDUCTOR-SMD	1.5uH,10%,2x1.25x0.85mm	
L205	2703-001334	INDUCTOR-SMD	1.5uH,10%,2x1.25x0.85mm	
L206	2703-001334	INDUCTOR-SMD	1.5uH,10%,2x1.25x0.85mm	
L207	2703-001334	INDUCTOR-SMD	1.5uH,10%,2x1.25x0.85mm	
L401	2703-001778	INDUCTOR-SMD	3.3UH,20%,3.2X2.5X2.2MM	
L402	2703-001778	INDUCTOR-SMD	3.3UH,20%,3.2X2.5X2.2MM	
L601	2703-001334	INDUCTOR-SMD	1.5uH,10%,2x1.25x0.85mm	
L602	2703-001334	INDUCTOR-SMD	1.5uH,10%,2x1.25x0.85mm	
L603	2703-001778	INDUCTOR-SMD	3.3UH,20%,3.2X2.5X2.2MM	
Q101	0505-001170	FET-SILICON	SI9933ADY-T1,P,-20V,3.4A,0.075	
Q102	0501-002080	TR-SMALL SIGNAL	2SC2412K,NPN,200mW,SOT-23,TP,1	
Q103	0501-002080	TR-SMALL SIGNAL	2SC2412K,NPN,200mW,SOT-23,TP,1	
Q105	0501-002080	TR-SMALL SIGNAL	2SC2412K,NPN,200mW,SOT-23,TP,1	
Q501	0501-002080	TR-SMALL SIGNAL	2SC2412K,NPN,200mW,SOT-23,TP,1	
Q502	0501-002080	TR-SMALL SIGNAL	2SC2412K,NPN,200mW,SOT-23,TP,1	
Q503	0501-002080	TR-SMALL SIGNAL	2SC2412K,NPN,200mW,SOT-23,TP,1	
R101	2007-000084	R-CHIP	4.7Kohm,5%,1/16W,DA,TP,1608	
R102	2007-000102	R-CHIP	100Kohm,5%,1/16W,DA,TP,1608	
R103	2007-000090	R-CHIP	10Kohm,5%,1/16W,DA,TP,1608	
R104	2007-000102	R-CHIP	100Kohm,5%,1/16W,DA,TP,1608	
R105	2007-000090	R-CHIP	10Kohm,5%,1/16W,DA,TP,1608	
R106	2007-000084	R-CHIP	4.7Kohm,5%,1/16W,DA,TP,1608	
R107	2007-000102	R-CHIP	100Kohm,5%,1/16W,DA,TP,1608	
R108	2007-000090	R-CHIP	10Kohm,5%,1/16W,DA,TP,1608	
R114	2007-000102	R-CHIP	100Kohm,5%,1/16W,DA,TP,1608	
R201	2007-000113	R-CHIP	33ohm,5%,1/16W,DA,TP,1608	
R202	2007-000113	R-CHIP	33ohm,5%,1/16W,DA,TP,1608	
R203	2007-001167	R-CHIP	75ohm,5%,1/16W,DA,TP,1608	
R204	2007-000113	R-CHIP	33ohm,5%,1/16W,DA,TP,1608	
R205	2007-001167	R-CHIP	75ohm,5%,1/16W,DA,TP,1608	
R206	2007-000107	R-CHIP	470Kohm,5%,1/16W,DA,TP,1608	

Loc. No.	Code No.	Description	Specification	Remarks
R207	2007-001167	R-CHIP	75ohm,5%,1/16W,DA,TP,1608	
R208	2007-000113	R-CHIP	33ohm,5%,1/16W,DA,TP,1608	
R209	2007-001167	R-CHIP	75ohm,5%,1/16W,DA,TP,1608	
R211	2007-001167	R-CHIP	75ohm,5%,1/16W,DA,TP,1608	
R212	2007-001167	R-CHIP	75ohm,5%,1/16W,DA,TP,1608	
R214	2007-000074	R-CHIP	100ohm,5%,1/16W,DA,TP,1608	
R215	2007-001167	R-CHIP	75ohm,5%,1/16W,DA,TP,1608	
R216	2007-000113	R-CHIP	33ohm,5%,1/16W,DA,TP,1608	
R217	2007-001167	R-CHIP	75ohm,5%,1/16W,DA,TP,1608	
R218	2007-000113	R-CHIP	33ohm,5%,1/16W,DA,TP,1608	
R219	2007-001167	R-CHIP	75ohm,5%,1/16W,DA,TP,1608	
R224	2007-000070	R-CHIP	0ohm,5%,1/16W,DA,TP,1608	
R225	2007-000070	R-CHIP	0ohm,5%,1/16W,DA,TP,1608	
R227	2007-000116	R-CHIP	120ohm,5%,1/16W,DA,TP,1608	
R229	2007-001114	R-CHIP	680Kohm,5%,1/16W,DA,TP,1608	
R230	2007-000113	R-CHIP	33ohm,5%,1/16W,DA,TP,1608	
R233	2007-000070	R-CHIP	0ohm,5%,1/16W,DA,TP,1608	
R234	2007-000070	R-CHIP	0ohm,5%,1/16W,DA,TP,1608	
R236	2007-000070	R-CHIP	0ohm,5%,1/16W,DA,TP,1608	
R237	2007-000074	R-CHIP	100ohm,5%,1/16W,DA,TP,1608	
R238	2007-000074	R-CHIP	100ohm,5%,1/16W,DA,TP,1608	
R240	2007-000118	R-CHIP	390ohm,5%,1/16W,DA,TP,1608	
R241	2007-000070	R-CHIP	0ohm,5%,1/16W,DA,TP,1608	
R242	2007-000118	R-CHIP	390ohm,5%,1/16W,DA,TP,1608	
R243	2007-000070	R-CHIP	0ohm,5%,1/16W,DA,TP,1608	
R248	2007-000070	R-CHIP	0ohm,5%,1/16W,DA,TP,1608	
R249	2007-000118	R-CHIP	390ohm,5%,1/16W,DA,TP,1608	
R250	2007-000070	R-CHIP	0ohm,5%,1/16W,DA,TP,1608	
R252	2007-000070	R-CHIP	0ohm,5%,1/16W,DA,TP,1608	
R254	2007-000070	R-CHIP	0ohm,5%,1/16W,DA,TP,1608	
R255	2007-000074	R-CHIP	100ohm,5%,1/16W,DA,TP,1608	
R256	2007-000080	R-CHIP	2Kohm,5%,1/16W,DA,TP,1608	
R257	2007-000080	R-CHIP	2Kohm,5%,1/16W,DA,TP,1608	
R258	2007-000090	R-CHIP	10Kohm,5%,1/16W,DA,TP,1608	
R259	2007-000090	R-CHIP	10Kohm,5%,1/16W,DA,TP,1608	
R260	2007-000074	R-CHIP	100ohm,5%,1/16W,DA,TP,1608	
R261	2007-000074	R-CHIP	100ohm,5%,1/16W,DA,TP,1608	
R262	2007-000070	R-CHIP	0ohm,5%,1/16W,DA,TP,1608	
R263	2007-000070	R-CHIP	0ohm,5%,1/16W,DA,TP,1608	
R267	2007-000070	R-CHIP	0ohm,5%,1/16W,DA,TP,1608	
R269	2007-000070	R-CHIP	0ohm,5%,1/16W,DA,TP,1608	
R301	2007-000239	R-CHIP	1.5Kohm,1%,1/16W,DA,TP,1608	
R302	2007-000071	R-CHIP	22ohm,5%,1/16W,DA,TP,1608	
R303	2007-000071	R-CHIP	22ohm,5%,1/16W,DA,TP,1608	
R304	2007-000071	R-CHIP	22ohm,5%,1/16W,DA,TP,1608	
R305	2007-000071	R-CHIP	22ohm,5%,1/16W,DA,TP,1608	
R306	2007-000071	R-CHIP	22ohm,5%,1/16W,DA,TP,1608	

7 Electrical Parts List

Loc. No.	Code No.	Description	Specification	Remarks
R307	2007-000090	R-CHIP	10Kohm,5%,1/16W,DA,TP,1608	
R310	2007-000071	R-CHIP	22ohm,5%,1/16W,DA,TP,1608	
R311	2007-000071	R-CHIP	22ohm,5%,1/16W,DA,TP,1608	
R312	2007-000084	R-CHIP	4.7Kohm,5%,1/16W,DA,TP,1608	
R313	2007-000084	R-CHIP	4.7Kohm,5%,1/16W,DA,TP,1608	
R316	2007-000090	R-CHIP	10Kohm,5%,1/16W,DA,TP,1608	
R317	2007-000090	R-CHIP	10Kohm,5%,1/16W,DA,TP,1608	
R343	2007-000090	R-CHIP	10Kohm,5%,1/16W,DA,TP,1608	
R401	2007-000074	R-CHIP	100ohm,5%,1/16W,DA,TP,1608	
R402	2007-000090	R-CHIP	10Kohm,5%,1/16W,DA,TP,1608	
R403	2007-000074	R-CHIP	100ohm,5%,1/16W,DA,TP,1608	
R404	2007-000071	R-CHIP	22ohm,5%,1/16W,DA,TP,1608	
R405	2007-000084	R-CHIP	4.7Kohm,5%,1/16W,DA,TP,1608	
R406	2007-001002	R-CHIP	510ohm,5%,1/16W,DA,TP,1608	
R407	2007-001002	R-CHIP	510ohm,5%,1/16W,DA,TP,1608	
R408	2007-001002	R-CHIP	510ohm,5%,1/16W,DA,TP,1608	
R409	2007-000084	R-CHIP	4.7Kohm,5%,1/16W,DA,TP,1608	
R410	2007-000084	R-CHIP	4.7Kohm,5%,1/16W,DA,TP,1608	
R411	2007-000071	R-CHIP	22ohm,5%,1/16W,DA,TP,1608	
R412	2007-000084	R-CHIP	4.7Kohm,5%,1/16W,DA,TP,1608	
R413	2007-000084	R-CHIP	4.7Kohm,5%,1/16W,DA,TP,1608	
R414	2007-000084	R-CHIP	4.7Kohm,5%,1/16W,DA,TP,1608	
R415	2007-000074	R-CHIP	100ohm,5%,1/16W,DA,TP,1608	
R416	2007-000074	R-CHIP	100ohm,5%,1/16W,DA,TP,1608	
R417	2007-000074	R-CHIP	100ohm,5%,1/16W,DA,TP,1608	
R418	2007-000074	R-CHIP	100ohm,5%,1/16W,DA,TP,1608	
R419	2007-000071	R-CHIP	22ohm,5%,1/16W,DA,TP,1608	
R420	2007-000120	R-CHIP	680ohm,5%,1/16W,DA,TP,1608	
R421	2007-000109	R-CHIP	1Mohm,5%,1/16W,DA,TP,1608	
R422	2007-000074	R-CHIP	100ohm,5%,1/16W,DA,TP,1608	
R425	2007-000070	R-CHIP	0ohm,5%,1/16W,DA,TP,1608	
R426	2007-000070	R-CHIP	0ohm,5%,1/16W,DA,TP,1608	
R427	2007-000071	R-CHIP	22ohm,5%,1/16W,DA,TP,1608	
R501	2007-000090	R-CHIP	10Kohm,5%,1/16W,DA,TP,1608	
R502	2007-000074	R-CHIP	100ohm,5%,1/16W,DA,TP,1608	
R503	2007-000074	R-CHIP	100ohm,5%,1/16W,DA,TP,1608	
R504	2007-000074	R-CHIP	100ohm,5%,1/16W,DA,TP,1608	
R505	2007-000074	R-CHIP	100ohm,5%,1/16W,DA,TP,1608	
R506	2007-000074	R-CHIP	100ohm,5%,1/16W,DA,TP,1608	
R507	2007-000074	R-CHIP	100ohm,5%,1/16W,DA,TP,1608	
R508	2007-000074	R-CHIP	100ohm,5%,1/16W,DA,TP,1608	
R509	2007-000074	R-CHIP	100ohm,5%,1/16W,DA,TP,1608	
R510	2007-000084	R-CHIP	4.7Kohm,5%,1/16W,DA,TP,1608	
R511	2007-000084	R-CHIP	4.7Kohm,5%,1/16W,DA,TP,1608	
R512	2007-000084	R-CHIP	4.7Kohm,5%,1/16W,DA,TP,1608	
R513	2007-000084	R-CHIP	4.7Kohm,5%,1/16W,DA,TP,1608	
R514	2007-000078	R-CHIP	1Kohm,5%,1/16W,DA,TP,1608	

Loc. No.	Code No.	Description	Specification	Remarks
R515	2007-000074	R-CHIP	100ohm,5%,1/16W,DA,TP,1608	
R516	2007-000074	R-CHIP	100ohm,5%,1/16W,DA,TP,1608	
R517	2007-000074	R-CHIP	100ohm,5%,1/16W,DA,TP,1608	
R518	2007-000084	R-CHIP	4.7Kohm,5%,1/16W,DA,TP,1608	
R519	2007-000074	R-CHIP	100ohm,5%,1/16W,DA,TP,1608	
R520	2007-000084	R-CHIP	4.7Kohm,5%,1/16W,DA,TP,1608	
R521	2007-000084	R-CHIP	4.7Kohm,5%,1/16W,DA,TP,1608	
R522	2007-000084	R-CHIP	4.7Kohm,5%,1/16W,DA,TP,1608	
R523	2007-000084	R-CHIP	4.7Kohm,5%,1/16W,DA,TP,1608	
R524	2007-000074	R-CHIP	100ohm,5%,1/16W,DA,TP,1608	
R525	2007-000075	R-CHIP	220ohm,5%,1/16W,DA,TP,1608	
R526	2007-000074	R-CHIP	100ohm,5%,1/16W,DA,TP,1608	
R527	2007-000076	R-CHIP	330ohm,5%,1/16W,DA,TP,1608	
R528	2007-000075	R-CHIP	220ohm,5%,1/16W,DA,TP,1608	
R529	2007-000074	R-CHIP	100ohm,5%,1/16W,DA,TP,1608	
R530	2007-000076	R-CHIP	330ohm,5%,1/16W,DA,TP,1608	
R531	2007-000078	R-CHIP	1Kohm,5%,1/16W,DA,TP,1608	
R532	2007-000074	R-CHIP	100ohm,5%,1/16W,DA,TP,1608	
R533	2007-000074	R-CHIP	100ohm,5%,1/16W,DA,TP,1608	
R534	2007-000077	R-CHIP	470ohm,5%,1/16W,DA,TP,1608	
R535	2007-000078	R-CHIP	1Kohm,5%,1/16W,DA,TP,1608	
R536	2007-000074	R-CHIP	100ohm,5%,1/16W,DA,TP,1608	
R537	2007-000074	R-CHIP	100ohm,5%,1/16W,DA,TP,1608	
R538	2007-000074	R-CHIP	100ohm,5%,1/16W,DA,TP,1608	
R539	2007-000074	R-CHIP	100ohm,5%,1/16W,DA,TP,1608	
R540	2007-000092	R-CHIP	15Kohm,5%,1/16W,DA,TP,1608	
R541	2007-000092	R-CHIP	15Kohm,5%,1/16W,DA,TP,1608	
R542	2007-000074	R-CHIP	100ohm,5%,1/16W,DA,TP,1608	
R543	2007-000074	R-CHIP	100ohm,5%,1/16W,DA,TP,1608	
R544	2007-000074	R-CHIP	100ohm,5%,1/16W,DA,TP,1608	
R545	2007-000074	R-CHIP	100ohm,5%,1/16W,DA,TP,1608	
R546	2007-000074	R-CHIP	100ohm,5%,1/16W,DA,TP,1608	
R547	2007-000074	R-CHIP	100ohm,5%,1/16W,DA,TP,1608	
R548	2007-000109	R-CHIP	1Mohm,5%,1/16W,DA,TP,1608	
R549	2007-000075	R-CHIP	220ohm,5%,1/16W,DA,TP,1608	
R550	2007-000078	R-CHIP	1Kohm,5%,1/16W,DA,TP,1608	
R551	2007-000077	R-CHIP	470ohm,5%,1/16W,DA,TP,1608	
R552	2007-000074	R-CHIP	100ohm,5%,1/16W,DA,TP,1608	
R555	2007-000074	R-CHIP	100ohm,5%,1/16W,DA,TP,1608	
R556	2007-000074	R-CHIP	100ohm,5%,1/16W,DA,TP,1608	
R601	2007-000090	R-CHIP	10Kohm,5%,1/16W,DA,TP,1608	
R602	2007-000070	R-CHIP	0ohm,5%,1/16W,DA,TP,1608	
R603	2007-000090	R-CHIP	10Kohm,5%,1/16W,DA,TP,1608	
R604	2007-000120	R-CHIP	680ohm,5%,1/16W,DA,TP,1608	
R605	2007-000071	R-CHIP	22ohm,5%,1/16W,DA,TP,1608	
RA301	2011-000002	R-NETWORK	22ohm,5%,1/16W,L,CHIP,8P,ST	
RA302	2011-000002	R-NETWORK	22ohm,5%,1/16W,L,CHIP,8P,ST	

7 Electrical Parts List



Loc. No.	Code No.	Description	Specification	Remarks
RA303	2011-000002	R-NETWORK	22ohm,5%,1/16W,L,CHIP,8P,ST	
RA304	2011-000002	R-NETWORK	22ohm,5%,1/16W,L,CHIP,8P,ST	
RA305	2011-000002	R-NETWORK	22ohm,5%,1/16W,L,CHIP,8P,ST	
RA306	2011-000002	R-NETWORK	22ohm,5%,1/16W,L,CHIP,8P,ST	
RA307	2011-000002	R-NETWORK	22ohm,5%,1/16W,L,CHIP,8P,ST	
RA308	2011-000002	R-NETWORK	22ohm,5%,1/16W,L,CHIP,8P,ST	
RA309	2011-000002	R-NETWORK	22ohm,5%,1/16W,L,CHIP,8P,ST	
RA310	2011-000002	R-NETWORK	22ohm,5%,1/16W,L,CHIP,8P,ST	
RA311	2011-000002	R-NETWORK	22ohm,5%,1/16W,L,CHIP,8P,ST	
RA312	2011-000002	R-NETWORK	22ohm,5%,1/16W,L,CHIP,8P,ST	
RA401	2011-000002	R-NETWORK	22ohm,5%,1/16W,L,CHIP,8P,ST	
RA402	2011-000002	R-NETWORK	22ohm,5%,1/16W,L,CHIP,8P,ST	
RA403	2011-000002	R-NETWORK	22ohm,5%,1/16W,L,CHIP,8P,ST	
RA404	2011-000002	R-NETWORK	22ohm,5%,1/16W,L,CHIP,8P,ST	
RA405	2011-000002	R-NETWORK	22ohm,5%,1/16W,L,CHIP,8P,ST	
RA406	2011-000002	R-NETWORK	22ohm,5%,1/16W,L,CHIP,8P,ST	
RA407	2011-000002	R-NETWORK	22ohm,5%,1/16W,L,CHIP,8P,ST	
RA408	2011-000002	R-NETWORK	22ohm,5%,1/16W,L,CHIP,8P,ST	
RA409	2011-000002	R-NETWORK	22ohm,5%,1/16W,L,CHIP,8P,ST	
RA410	2011-000002	R-NETWORK	22ohm,5%,1/16W,L,CHIP,8P,ST	
RA411	2011-000002	R-NETWORK	22ohm,5%,1/16W,L,CHIP,8P,ST	
RA412	2011-000002	R-NETWORK	22ohm,5%,1/16W,L,CHIP,8P,ST	
RA413	2011-000002	R-NETWORK	22ohm,5%,1/16W,L,CHIP,8P,ST	
RA414	2011-000002	R-NETWORK	22ohm,5%,1/16W,L,CHIP,8P,ST	
RA415	2011-000002	R-NETWORK	22ohm,5%,1/16W,L,CHIP,8P,ST	
RA416	2011-000002	R-NETWORK	22ohm,5%,1/16W,L,CHIP,8P,ST	
RA417	2011-000002	R-NETWORK	22ohm,5%,1/16W,L,CHIP,8P,ST	
RA418	2011-000002	R-NETWORK	22ohm,5%,1/16W,L,CHIP,8P,ST	
U2	2203-005005	C-CERAMIC,CHIP	100nF,15%,16V,W5R,TP,1608,1.6m	
U6	2901-001114	FILTER-EMI SMD	25VDC,2.0ADC,100nF,3.2x1.6x1	
U7	2203-005005	C-CERAMIC,CHIP	100nF,15%,16V,W5R,TP,1608,1.6m	
U8	1204-001551	IC-VIDEO SYSTEM	GS1881,SOIC,8P,150MIL,PLASTIC	
X401	2801-003667	CRYSTAL-SMD	14.3182MHZ,50PPM,28-AAN,16,500	
X501	2801-003326	CRYSTAL-SMD	24MHz,30ppm,28-ABX,16pF,50ohm	

7-2 Sub PCB Parts

Loc. No.	Code No.	Description	Specification	Remarks
CN1	3711-002050	CONNECTOR-HEADER	BOX,10P,1R,1.25mm,SMD-A,SN	
OP4	0601-001036	LED	ROUND,GRN/YEL,4.75mm,565/585nm	
OP5	0601-001036	LED	ROUND,GRN/YEL,4.75mm,565/585nm	
OP6	0601-001036	LED	ROUND,GRN/YEL,4.75mm,565/585nm	
Q1	0501-002080	TR-SMALL SIGNAL	2SC2412K,NPN,200mW,SOT-23,TP,1	
Q2	0501-002080	TR-SMALL SIGNAL	2SC2412K,NPN,200mW,SOT-23,TP,1	
R1	2007-000766	R-CHIP	330ohm,5%,1/10W,DA,TP,2012	
R2	2007-000766	R-CHIP	330ohm,5%,1/10W,DA,TP,2012	
R3	2007-000221	R-CHIP	1.2Kohm,5%,1/10W,DA,TP,2012	
R4	2007-000221	R-CHIP	1.2Kohm,5%,1/10W,DA,TP,2012	
R5	2007-000290	R-CHIP	100ohm,5%,1/10W,DA,TP,2012	
R6	2007-000844	R-CHIP	3Kohm,5%,1/10W,DA,TP,2012	
R7	2007-000844	R-CHIP	3Kohm,5%,1/10W,DA,TP,2012	
R10	2007-000355	R-CHIP	12Kohm,5%,1/10W,DA,TP,2012	
R11	2007-000300	R-CHIP	10Kohm,5%,1/10W,DA,TP,2012	
R12	2007-000355	R-CHIP	12Kohm,5%,1/10W,DA,TP,2012	
R13	2007-000300	R-CHIP	10Kohm,5%,1/10W,DA,TP,2012	
R14	2007-000290	R-CHIP	100ohm,5%,1/10W,DA,TP,2012	
SW1	3404-000243	SWITCH-TACT	15V,20mA,160gf+-50gf,6x3.4mm,S	
SW2	3404-000243	SWITCH-TACT	15V,20mA,160gf+-50gf,6x3.4mm,S	
SW3	3404-000243	SWITCH-TACT	15V,20mA,160gf+-50gf,6x3.4mm,S	
SW4	3404-000243	SWITCH-TACT	15V,20mA,160gf+-50gf,6x3.4mm,S	
SW5	3404-000243	SWITCH-TACT	15V,20mA,160gf+-50gf,6x3.4mm,S	
SW6	3404-000243	SWITCH-TACT	15V,20mA,160gf+-50gf,6x3.4mm,S	

7 Electrical Parts List

Others

Loc. No.	Code No.	Description	Specification	Remarks
LCD	BN07-10001D	LCD	LT170X2-131, 404*322.5*25,IPS	
PROCESS-PBA UNIT	BN94-00022B	ASS'Y PCB	DV17MSS	
S/CABLE	BN39-20001E	CBF-SIGNAL	DET,1830MM,15P/15P,IVORY,UL29	
P/CORD	BH39-10339Z	CBF-POWER/CORD	DET,RVV3,250V/10A,BLK,18	CHINA
	BH39-10005A	CBF-POWER/CORD	CAP,1200MM, 250V/10A, BLK,18	UK, THAILAND
	BH39-10007A	CBF-POWER/CORD	WALL,1830MM,250V/6A,IVY	SEG,SESA,SEF
	BH39-10339E	CBF-POWER/CORD	DET,SVT,125V 7A/10A,IVY	SEA,SESA
	BH39-10006A	CBF-POWER/CORD	WALL,1830MM,250V/10A,IVY	SEAU
ADAPTER	BN44-00024A			
INVERTER	BN13-10001H			 

8 Block Diagram

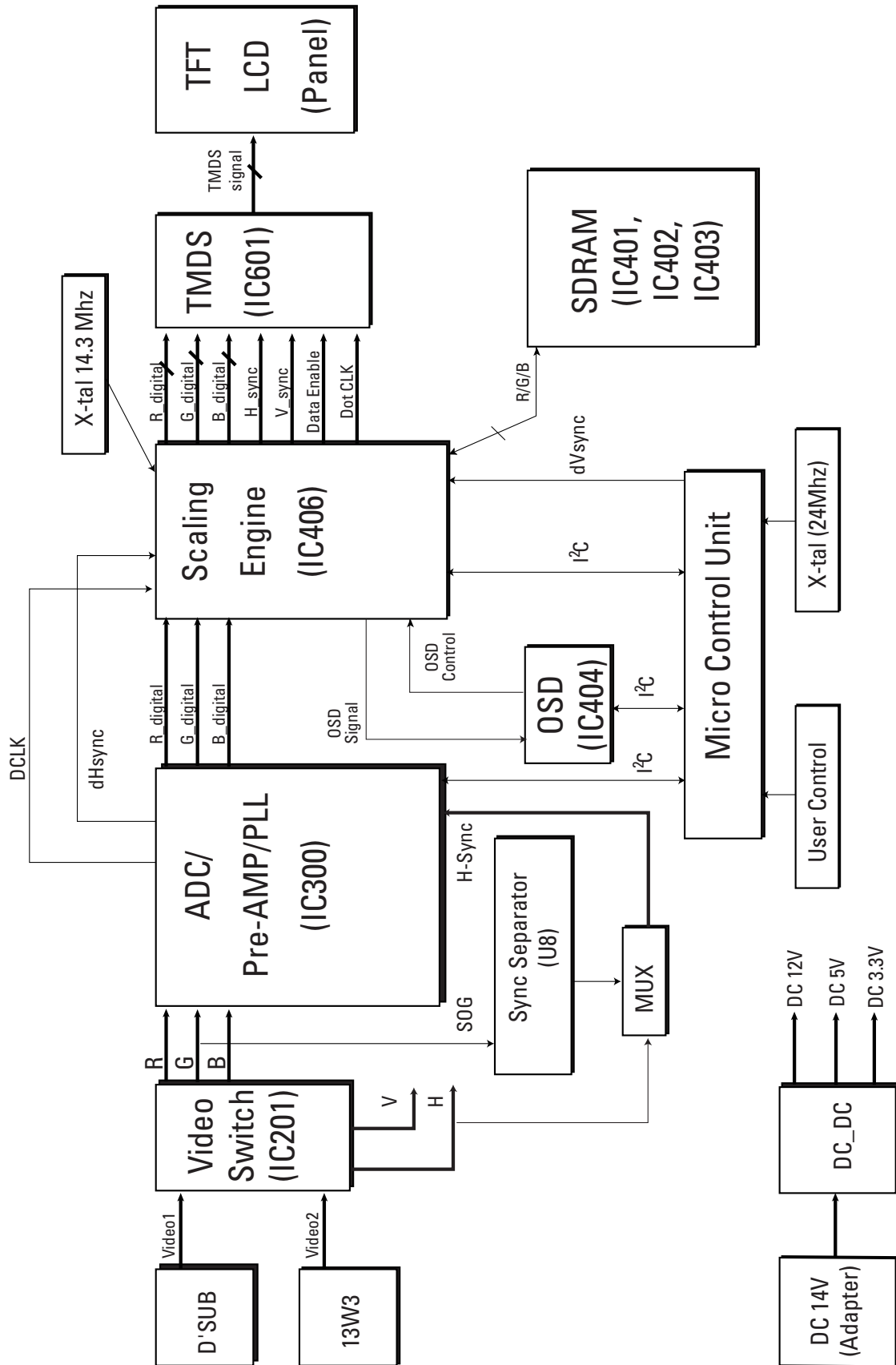

Memo

9 Wiring Diagram

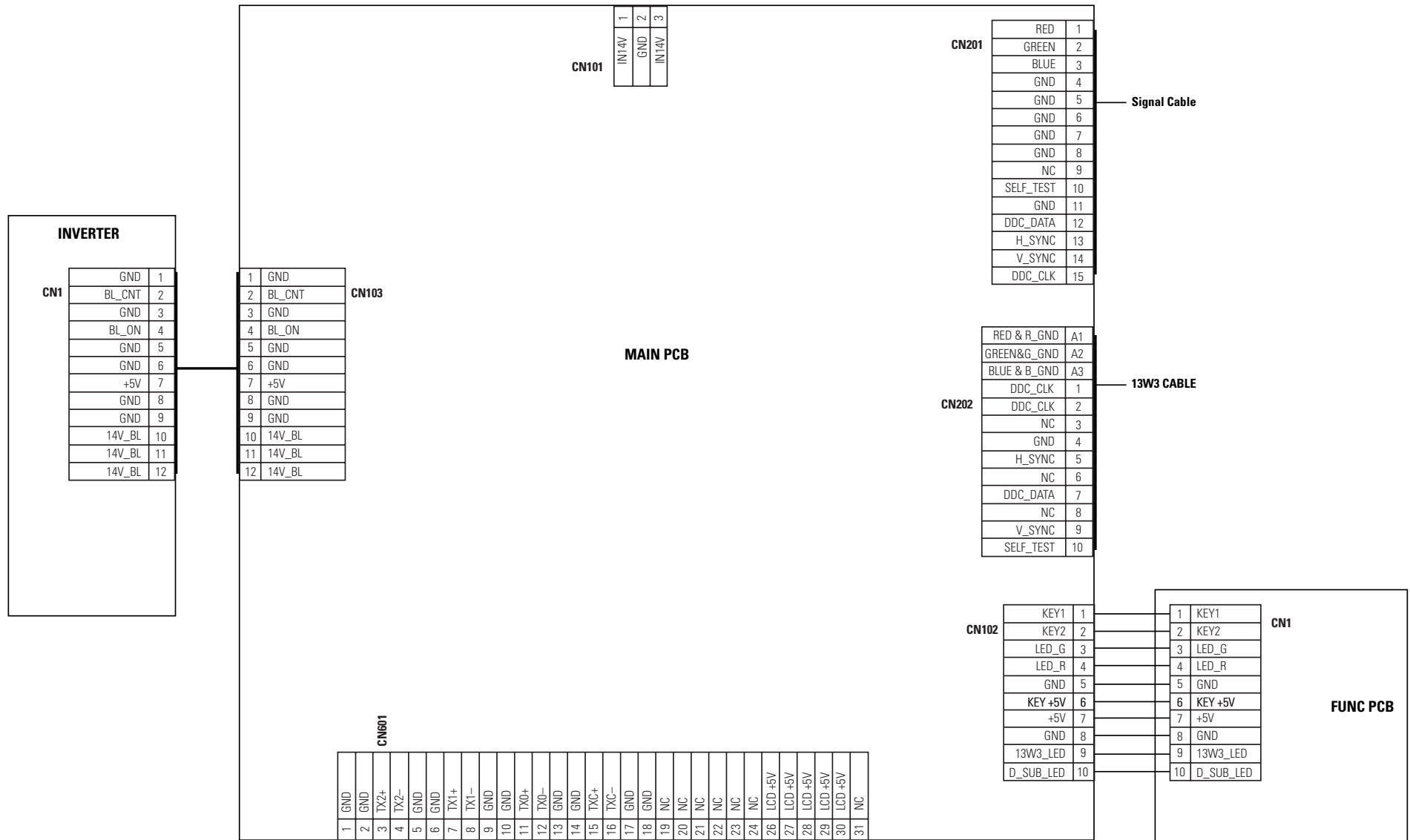

Memo

10-2 Scaler Chip Part Schematic Diagram

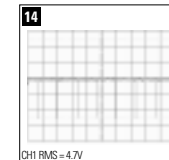
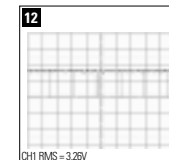
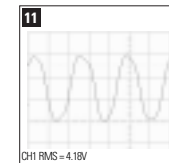
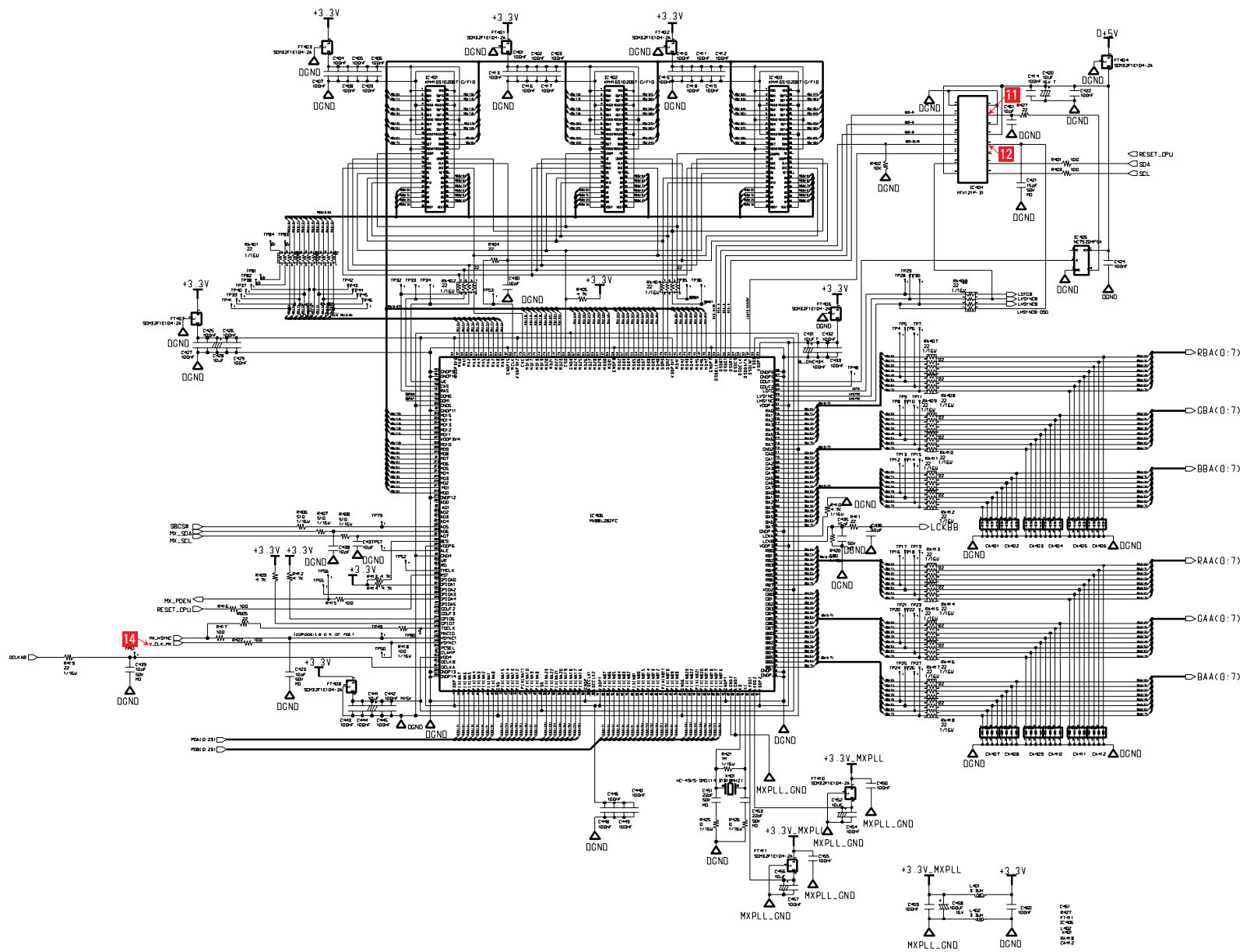

10-3 Power input Part Schematic Diagram

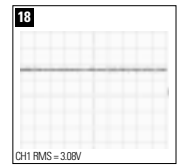
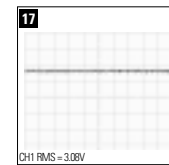
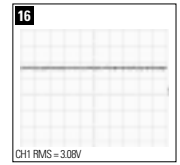
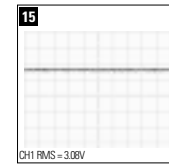
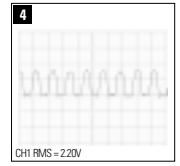
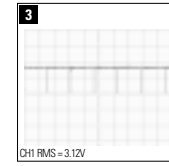
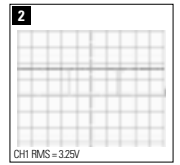
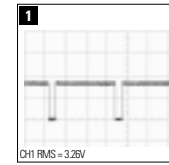
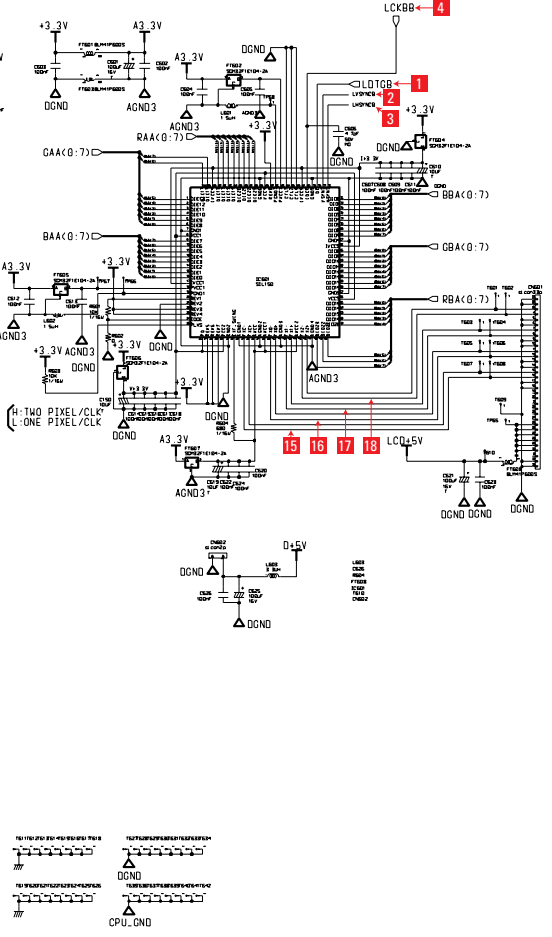
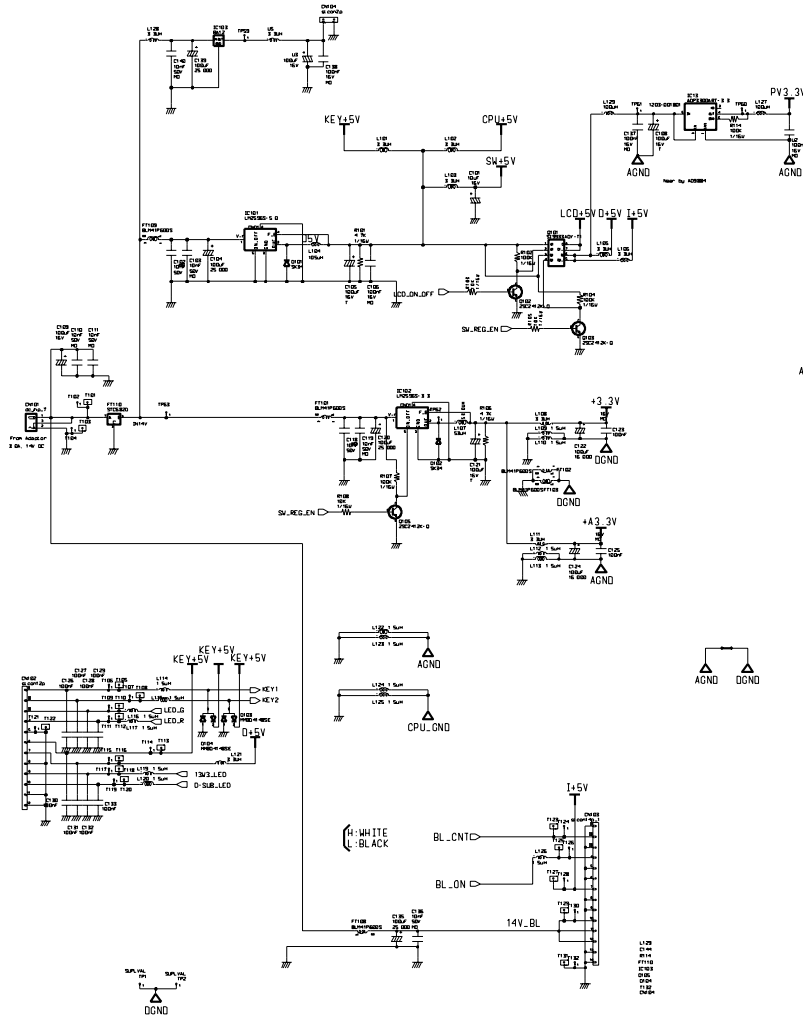

10-4 Micom Part Schematic Diagram

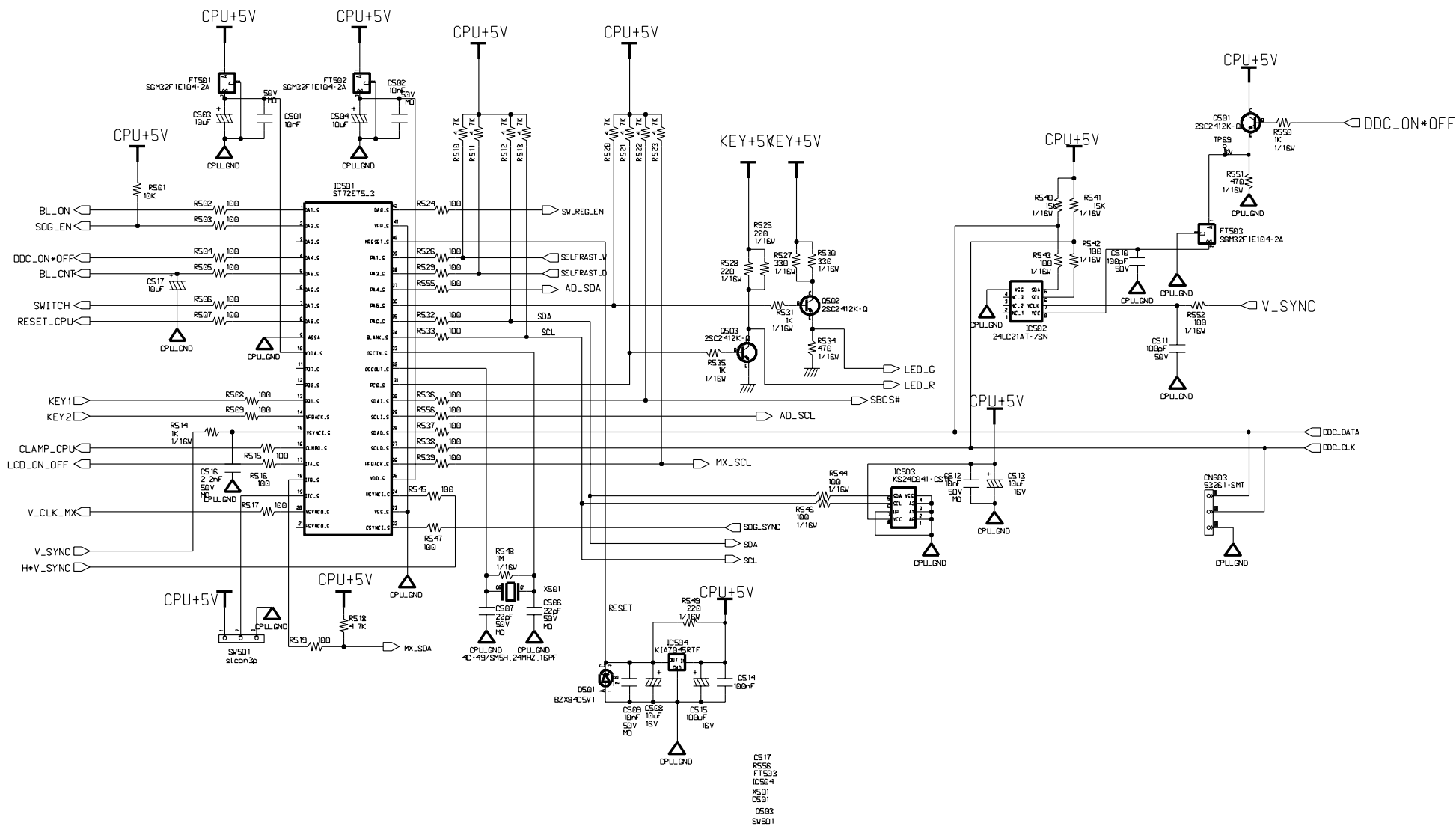

10-5 A/D Converter Part Schematic Diagram

