

**NDP610A / NDP610AE / NDP610B / NDP610BE
NDB610A / NDB610AE / NDB610B / NDB610BE
N-Channel Enhancement Mode Field Effect Transistor**

General Description

These N-channel enhancement mode power field effect transistors are produced using Fairchild's proprietary, high cell density, DMOS technology. This very high density process has been especially tailored to minimize on-state resistance, provide superior switching performance, and withstand high energy pulses in the avalanche and commutation modes. These devices are particularly suited for low voltage applications such as automotive, DC/DC converters, PWM motor controls, and other battery powered circuits where fast switching, low in-line power loss, and resistance to transients are needed.

Features

- 26 and 24A, 100V. $R_{DS(ON)} = 0.065$ and 0.080Ω .
- Critical DC electrical parameters specified at elevated temperature.
- Rugged internal source-drain diode can eliminate the need for an external Zener diode transient suppressor.
- 175°C maximum junction temperature rating.
- High density cell design (3 million/in²) for extremely low $R_{DS(ON)}$.
- TO-220 and TO-263 (D²PAK) package for both through hole and surface mount applications.

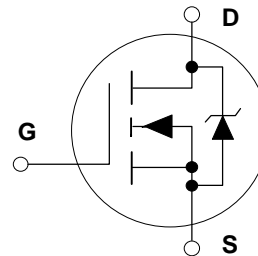
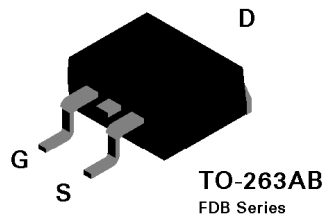
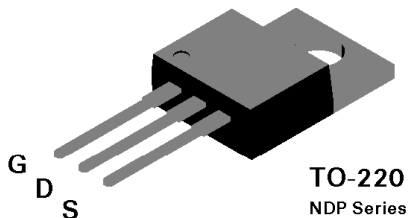

Absolute Maximum Ratings

$T_c = 25^\circ\text{C}$ unless otherwise noted

Symbol	Parameter	NDP610A	NDP610AE	NDP610B	NDP610BE	Units
		NDB610A	NDB610AE	NDB610B	NDB610BE	
V_{DSS}	Drain-Source Voltage	100				V
V_{DGR}	Drain-Gate Voltage ($R_{GS} \leq 1\text{ M}\Omega$)	100				V
V_{GSS}	Gate-Source Voltage - Continuous	± 20				V
	- Nonrepetitive ($t_p < 50\ \mu\text{s}$)	± 40				V
I_D	Drain Current - Continuous	26		24		A
	- Pulsed	104		96		A
P_D	Total Power Dissipation @ $T_c = 25^\circ\text{C}$	100				W
	Derate above 25°C	0.67				W/ $^\circ\text{C}$
T_J, T_{STG}	Operating and Storage Temperature Range	-65 to 175				$^\circ\text{C}$
T_L	Maximum lead temperature for soldering purposes, 1/8" from case for 5 seconds	275				$^\circ\text{C}$

Electrical Characteristics (T_c = 25°C unless otherwise noted)

Symbol	Parameter	Conditions	Type	Min	Typ	Max	Units
DRAIN-SOURCE AVALANCHE RATINGS (Note 1)							
E _{AS}	Single Pulse Drain-Source Avalanche Energy	V _{DD} = 25 V, I _D = 26 A	NDP610AE NDP610BE			250	mJ
I _{AR}	Maximum Drain-Source Avalanche Current		NDB610AE NDB610BE			26	A
OFF CHARACTERISTICS							
BV _{DSS}	Drain-Source Breakdown Voltage	V _{GS} = 0 V, I _D = 250 μA	ALL	100			V
I _{DSS}	Zero Gate Voltage Drain Current	V _{DS} = 100 V, V _{GS} = 0 V	ALL			250	μA
		T _J = 125°C				1	mA
I _{GSSF}	Gate - Body Leakage, Forward	V _{GS} = 20 V, V _{DS} = 0 V	ALL			100	nA
I _{GSSR}	Gate - Body Leakage, Reverse	V _{GS} = -20 V, V _{DS} = 0 V	ALL			-100	nA
ON CHARACTERISTICS (Note 2)							
V _{GS(th)}	Gate Threshold Voltage	V _{DS} = V _{GS} , I _D = 250 μA	ALL	2	3	4	V
		T _J = 125°C		1.4	2.3	3.2	V
R _{DS(ON)}	Static Drain-Source On-Resistance	V _{GS} = 10 V, I _D = 13 A	NDP610A NDP610AE NDB610A		0.048	0.065	Ω
		T _J = 125°C	NDB610AE		0.086	0.13	Ω
		V _{GS} = 10 V, I _D = 12 A	NDP610B NDP610BE NDB610B			0.08	Ω
		T _J = 125°C	NDB610BE			0.16	Ω
I _{D(on)}	On-State Drain Current	V _{GS} = 10 V, V _{DS} = 10 V	NDP610A NDP610AE NDB610A NDB610AE	26			A
			NDP610B NDP610BE NDB610B NDB610BE	24			A
g _{FS}	Forward Transconductance	V _{DS} = 10 V, I _D = 13 A	ALL	10	16		S
DYNAMIC CHARACTERISTICS							
C _{iss}	Input Capacitance	V _{DS} = 25 V, V _{GS} = 0 V, f = 1.0 MHz	ALL		1430	1800	pF
C _{oss}	Output Capacitance		ALL		280	500	pF
C _{rss}	Reverse Transfer Capacitance		ALL		85	200	pF

Electrical Characteristics (T_c = 25°C unless otherwise noted)

Symbol	Parameter	Conditions	Type	Min	Typ	Max	Units	
SWITCHING CHARACTERISTICS (Note 2)								
t _{D(ON)}	Turn - On Delay Time	V _{DD} = 50 V, I _D = 26 A, V _{GS} = 10 V, R _{GEN} = 7.5 Ω	ALL		11	20	nS	
t _r	Turn - On Rise Time		ALL		72	120	nS	
t _{D(OFF)}	Turn - Off Delay Time		ALL		40	65	nS	
t _f	Turn - Off Fall Time		ALL		52	85	nS	
Q _g	Total Gate Charge	V _{DS} = 80 V, I _D = 26 A, V _{GS} = 10V	ALL		47	65	nC	
Q _{gs}	Gate-Source Charge		ALL		8		nC	
Q _{gd}	Gate-Drain Charge		ALL		22		nC	
DRAIN-SOURCE DIODE CHARACTERISTICS								
I _S	Maximum Continuous Drain-Source Diode Forward Current		NDP610A NDP610AE NDB610A NDB610AE			26	A	
			NDP610B NDP610BE NDB610B NDB610BE			24	A	
I _{SM}	Maximum Pulsed Drain-Source Diode Forward Current		NDP610A NDP610AE NDB610A NDB610AE			104	A	
			NDP610B NDP610BE NDB610B NDB610BE			96	A	
V _{SD} (Note 2)	Drain-Source Diode Forward Voltage	V _{GS} = 0 V, I _S = 13 A		T _J = 125°C		0.88	1.3	V
						0.83	1.2	V
t _{rr}	Reverse Recovery Time	V _{GS} = 0 V, I _S = 26 A, di _s /dt = 100 A/μs	ALL		108	155	ns	
I _{rr}	Reverse Recovery Current		ALL		7.4	11	A	
THERMAL CHARACTERISTICS								
R _{θJC}	Thermal Resistance, Junction-to-Case		ALL			1.5	°C/W	
R _{θJA}	Thermal Resistance, Junction-to-Ambient		ALL			62.5	°C/W	

Notes:

1. NDP610A/610B and NDB610A/610B are not rated for operation in avalanche mode.
2. Pulse Test: Pulse Width ≤ 300 μs, Duty Cycle ≤ 2.0%.

Typical Electrical Characteristics

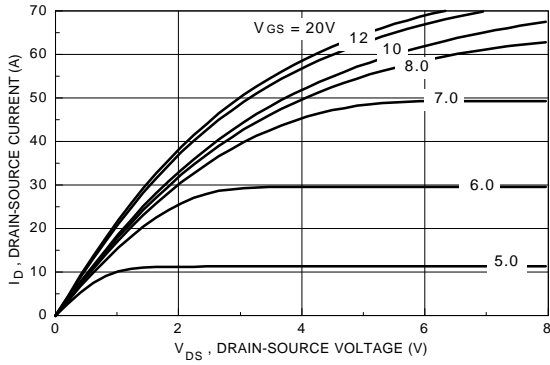

Figure 1. On-Region Characteristics.

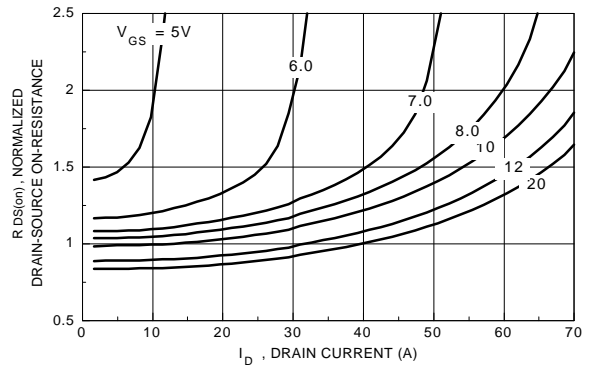

Figure 2. On-Resistance Variation with Gate Voltage and Drain Current.

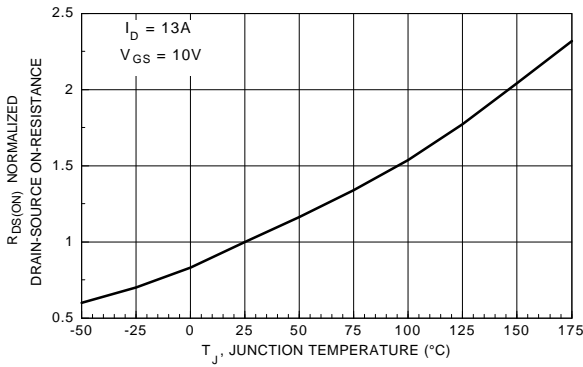

Figure 3. On-Resistance Variation with Temperature.

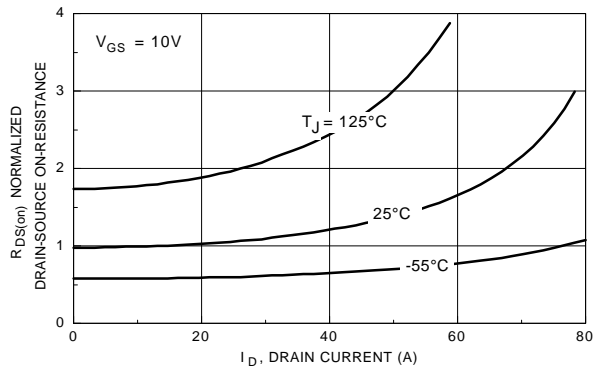

Figure 4. On-Resistance Variation with Drain Current and Temperature.

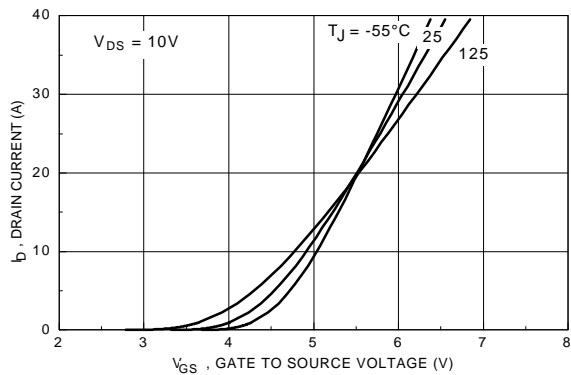

Figure 5. Transfer Characteristics.

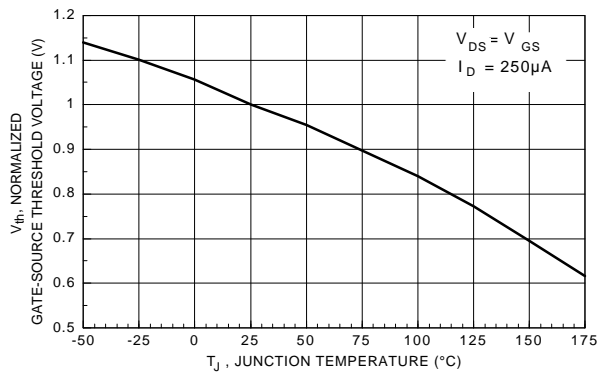

Figure 6. Gate Threshold Variation with Temperature.

Typical Electrical Characteristics (continued)

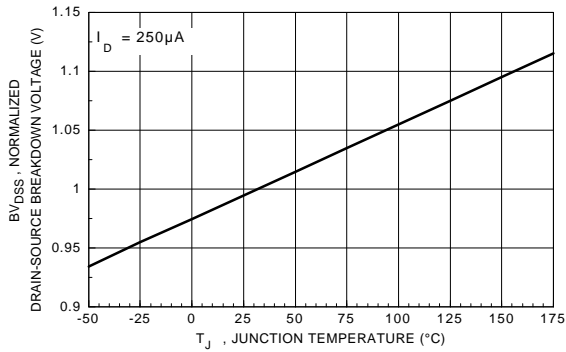

Figure 7. Breakdown Voltage Variation with Temperature.

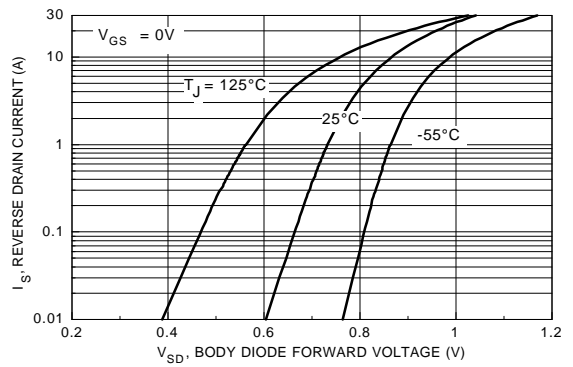

Figure 8. Body Diode Forward Voltage Variation with Current and Temperature.

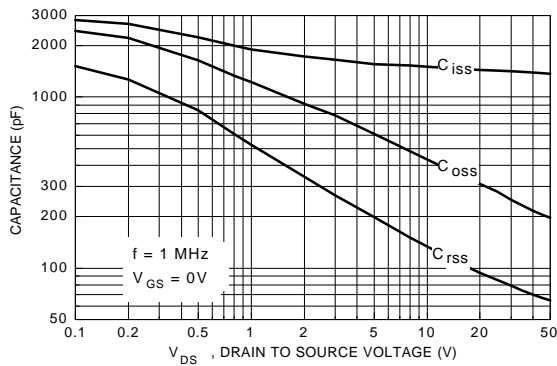

Figure 9. Capacitance Characteristics.

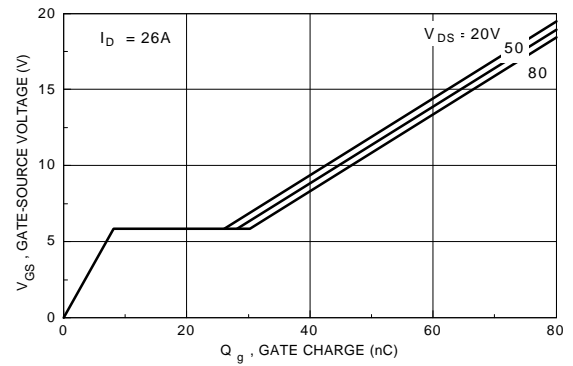

Figure 10. Gate Charge Characteristics.

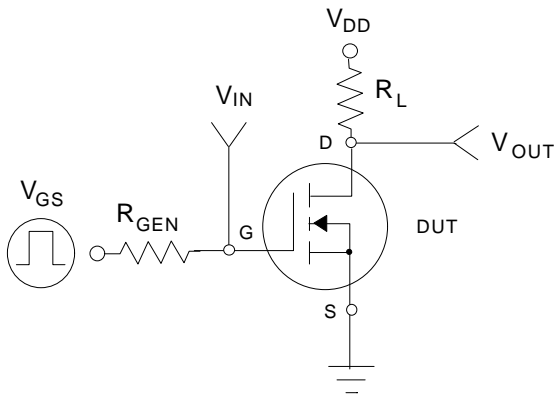

Figure 36. Switching Test Circuit.

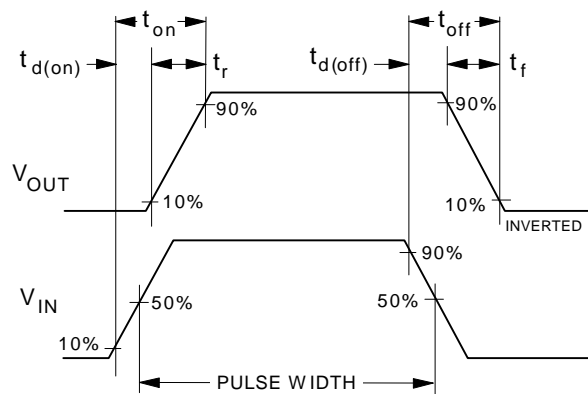

Figure 12. Switching Waveforms.

Typical Electrical Characteristics (continued)

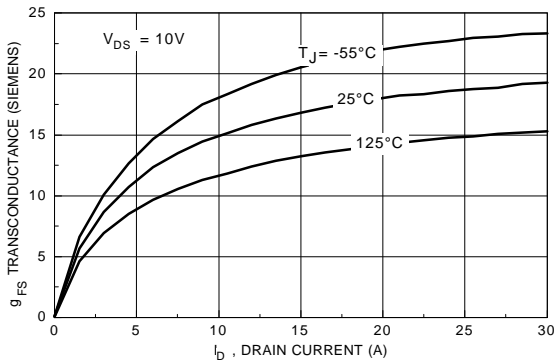

Figure 13. Transconductance Variation with Drain Current and Temperature.

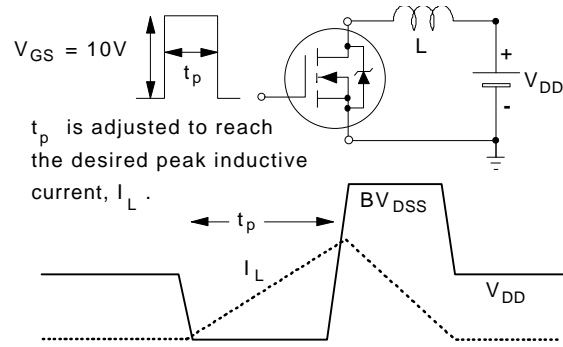

Figure 14. Unclamped Inductive Load Circuit and Waveforms.

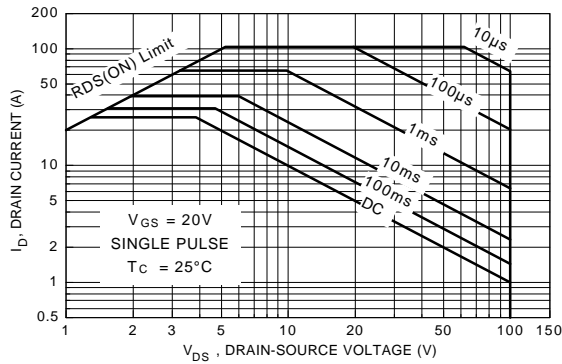

Figure 15. Maximum Safe Operating Area.

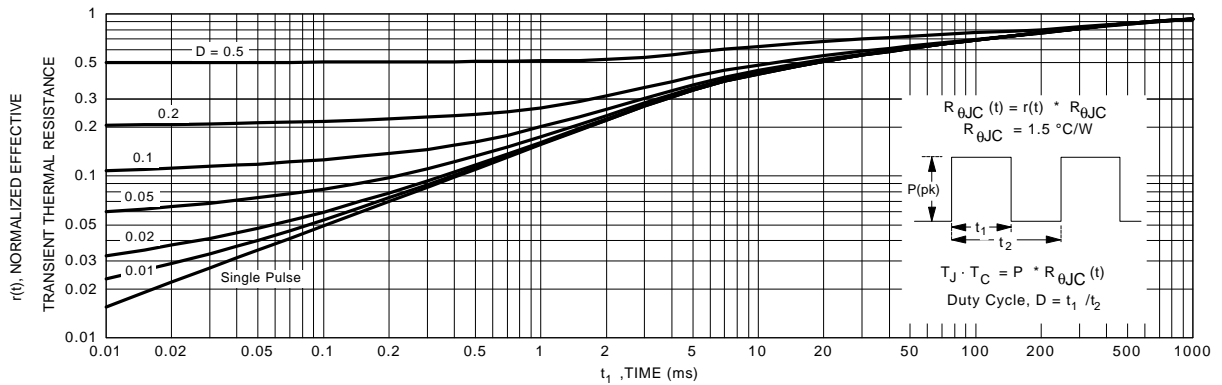

Figure 16. Transient Thermal Response Curve.