

TN3725A

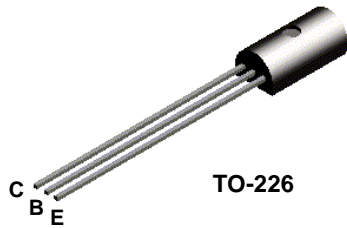

MMPQ3725

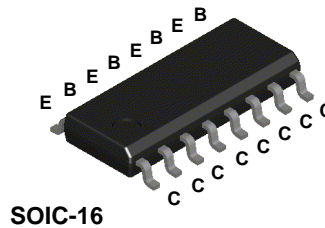

NPN Switching Transistor

This device is designed for high speed core driver applications up to collector currents of 1.0 A. Sourced from Process 25.

Absolute Maximum Ratings

TA = 25°C unless otherwise noted

Symbol	Parameter	Value	Units
V _{CEO}	Collector-Emitter Voltage	40	V
V _{CBO}	Collector-Base Voltage	60	V
V _{EBO}	Emitter-Base Voltage	6.0	V
I _C	Collector Current - Continuous	1.2	A
T _J , T _{stg}	Operating and Storage Junction Temperature Range	-55 to +150	°C

*These ratings are limiting values above which the serviceability of any semiconductor device may be impaired.

NOTES:

- 1) These ratings are based on a maximum junction temperature of 150 degrees C.
- 2) These are steady state limits. The factory should be consulted on applications involving pulsed or low duty cycle operations.

Thermal Characteristics

TA = 25°C unless otherwise noted

Symbol	Characteristic	Max		Units
		TN3725A	MMPQ3725	
P _D	Total Device Dissipation Derate above 25°C	1.0	1.0	W
		8.0	8.0	mW/°C
R _{θJC}	Thermal Resistance, Junction to Case	50		°C/W
R _{θJA}	Thermal Resistance, Junction to Ambient Effective 4 Die Each Die	125		°C/W
			125	°C/W
			240	°C/W

NPN Switching Transistor

(continued)

Electrical Characteristics

TA= 25°C unless otherwise noted

Symbol	Parameter	Test Conditions	Min	Max	Units
OFF CHARACTERISTICS					
$V_{(BR)CEO}$	Collector-Emitter Breakdown Voltage*	$I_C = 10 \text{ mA}, I_B = 0$	40		V
$V_{(BR)CES}$	Collector-Emitter Breakdown Voltage	$I_C = 10 \text{ } \mu\text{A}, V_{BE} = 0$	60		V
$V_{(BR)CBO}$	Collector-Base Breakdown Voltage	$I_C = 10 \text{ } \mu\text{A}, I_{CE} = 0$	60		V
$V_{(BR)EBO}$	Emitter-Base Breakdown Voltage	$I_E = 10 \text{ } \mu\text{A}, I_C = 0$	6.0		V
I_{CBO}	Collector Cutoff Current	$V_{CB} = 60 \text{ V}, I_E = 0$ $V_{CB} = 60 \text{ V}, I_E = 0, T_A = 100^\circ\text{C}$		1.7 120	μA μA
I_{CES}	Collector Cutoff Current	$V_{CE} = 80 \text{ V}, V_{EB} = 0$		10	μA

ON CHARACTERISTICS*

h_{FE}	DC Current Gain	$I_C = 10 \text{ mA}, V_{CE} = 1.0 \text{ V}$ $I_C = 100 \text{ mA}, V_{CE} = 1.0 \text{ V}$ $I_C = 100 \text{ mA}, V_{CE} = 1.0 \text{ V}, T_A = -55^\circ\text{C}$ $I_C = 300 \text{ mA}, V_{CE} = 1.0 \text{ V}$ $I_C = 500 \text{ mA}, V_{CE} = 1.0 \text{ V}$ $I_C = 500 \text{ mA}, V_{CE} = 1.0 \text{ V}, T_A = -55^\circ\text{C}$ $I_C = 800 \text{ mA}, V_{CE} = 2.0 \text{ V}$ $I_C = 1.0 \text{ A}, V_{CE} = 5.0 \text{ V}$	30 60 30 40 35 20 20 25	150	
$V_{CE(sat)}$	Collector-Emitter Saturation Voltage	$I_C = 10 \text{ mA}, I_B = 1.0 \text{ mA}$ $I_C = 100 \text{ mA}, I_B = 10 \text{ mA}$ $I_C = 300 \text{ mA}, I_B = 30 \text{ mA}$ $I_C = 500 \text{ mA}, I_B = 50 \text{ mA}$ $I_C = 800 \text{ mA}, I_B = 80 \text{ mA}$ $I_C = 1.0 \text{ A}, I_B = 100 \text{ mA}$		0.25 0.26 0.4 0.52 0.8 0.95	V V V V V V
$V_{BE(sat)}$	Base-Emitter Saturation Voltage	$I_C = 10 \text{ mA}, I_B = 1.0 \text{ mA}$ $I_C = 100 \text{ mA}, I_B = 10 \text{ mA}$ $I_C = 300 \text{ mA}, I_B = 30 \text{ mA}$ $I_C = 500 \text{ mA}, I_B = 50 \text{ mA}$ $I_C = 800 \text{ mA}, I_B = 80 \text{ mA}$ $I_C = 1.0 \text{ A}, I_B = 100 \text{ mA}$		0.76 0.86 1.1 1.2 1.5 1.7	V V V V V V

SMALL SIGNAL CHARACTERISTICS

f_T	Current Gain - Bandwidth Product	$I_C = 50 \text{ mA}, V_{CE} = 10 \text{ V},$ $f = 100 \text{ MHz}$	300		MHz
C_{obo}	Output Capacitance	$V_{CB} = 10 \text{ V}, I_E = 0,$ $f = 1.0 \text{ MHz}$		10	pF
C_{ibo}	Input Capacitance	$V_{EB} = 0.5 \text{ V}, I_C = 0,$ $f = 1.0 \text{ MHz}$		55	pF

SWITCHING CHARACTERISTICS (except MMPQ3725)

t_{on}	Turn-on Time	$V_{CC} = 30 \text{ V}, V_{BE(off)} = 3.8 \text{ V},$		35	ns
t_d	Delay Time	$I_C = 500 \text{ mA}, I_{B1} = 50 \text{ mA}$		10	ns
t_r	Rise Time			30	ns
t_{off}	Turn-off Time	$V_{CC} = 30 \text{ V}, I_C = 500 \text{ mA}$		60	ns
t_s	Storage Time	$I_{B1} = I_{B2} = 50 \text{ mA}$		50	ns
t_f	Fall Time			30	ns

*Pulse Test: Pulse Width $\leq 300 \text{ } \mu\text{s}$, Duty Cycle $\leq 1.0\%$

TN3725A / MMPQ3725

DC Typical Characteristics

Typical Pulsed Current Gain vs Collector Current

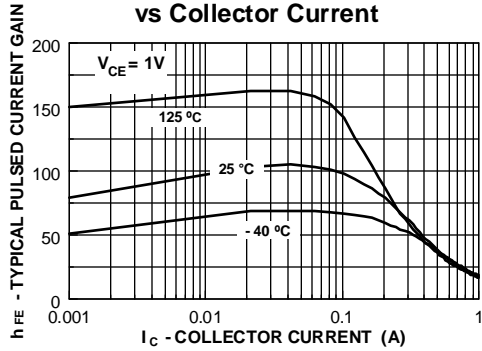

Collector-Emitter Saturation Voltage vs Collector Current

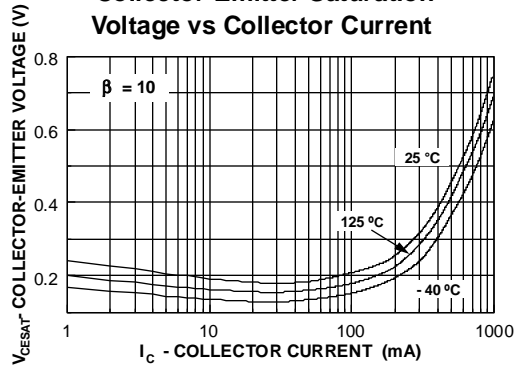

Base-Emitter Saturation Voltage vs Collector Current

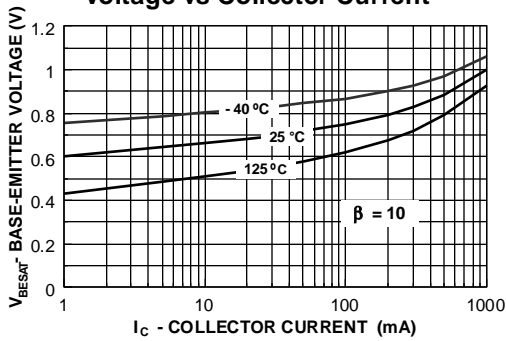

Base-Emitter ON Voltage vs Collector Current

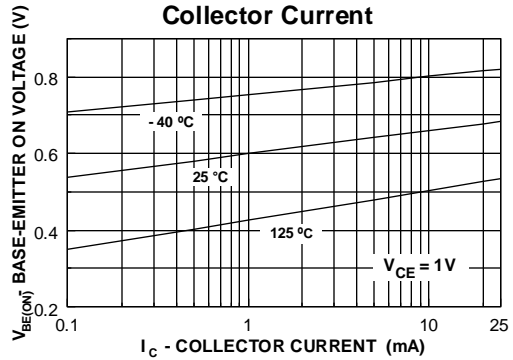

Collector-Cutoff Current vs Ambient Temperature

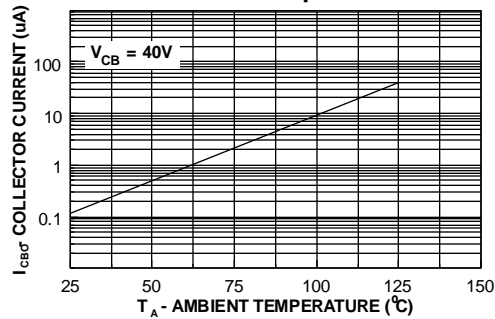

AC Typical Characteristics

Input/Output Capacitance vs. Reverse Bias

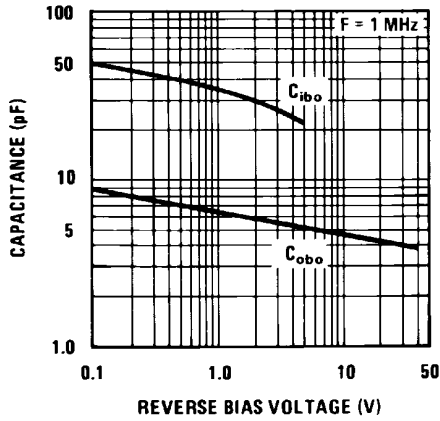

Contours of Constant Bandwidth Product (f_T)

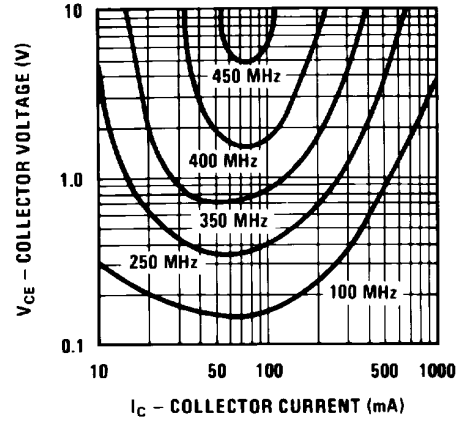

Switching Time vs. Collector Current

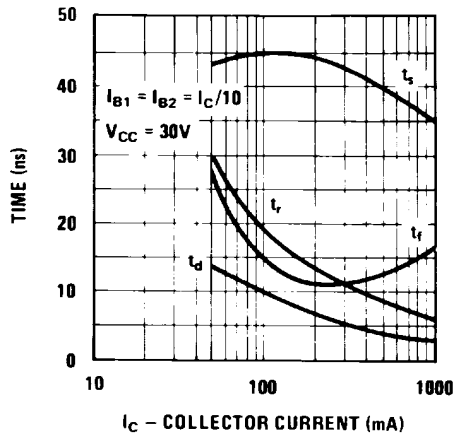

Turn On / Turn Off Times vs. Collector Current

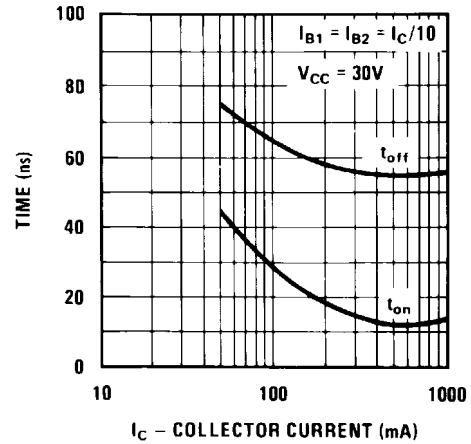

Switching Times vs. Ambient Temperature

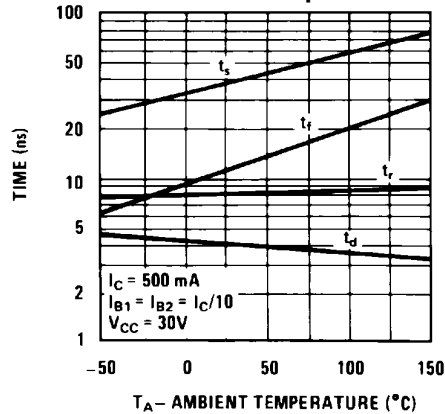

Delay Time vs. Turn On Base Current and Reverse Base-Emitter Voltage

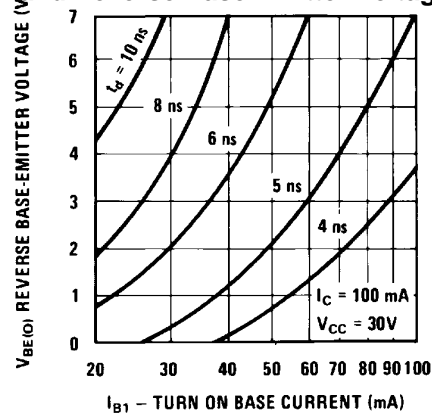

AC Typical Characteristics (continued)

Rise Time vs. Collector and Turn On Base Currents

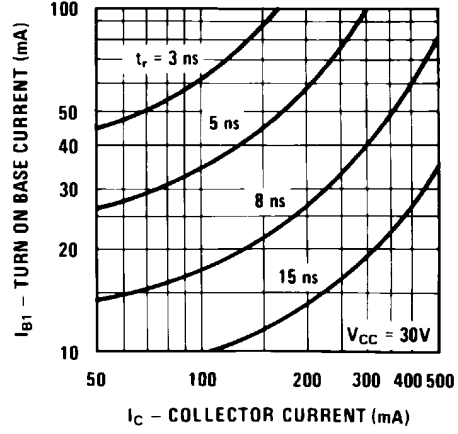

Storage Time vs. Turn On and Turn Off Base Currents

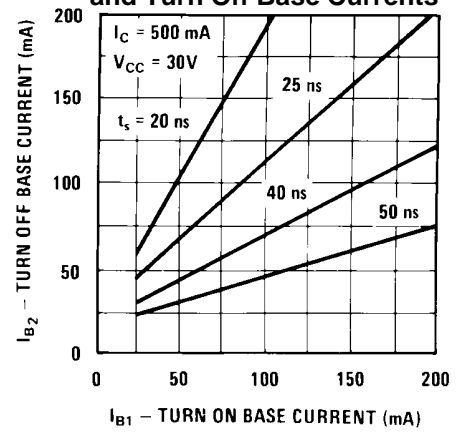

Storage Time vs. Turn On and Turn Off Base Currents

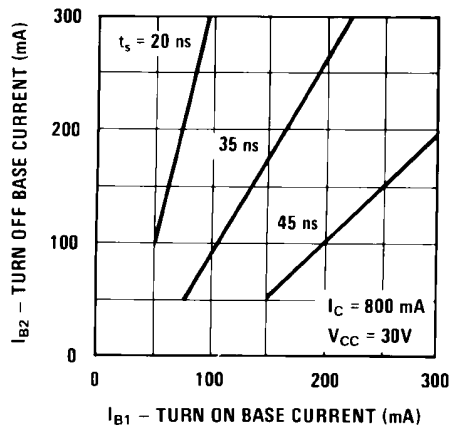

Storage Time vs. Turn On and Turn Off Base Currents

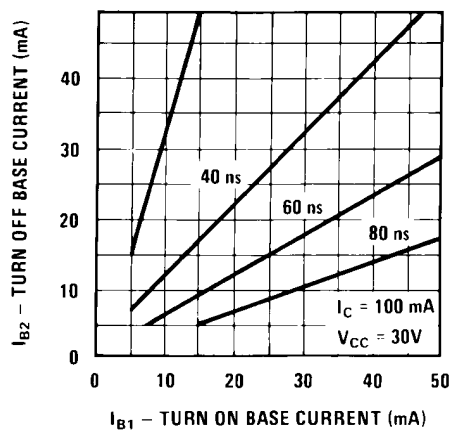

Fall Time vs. Turn On and Turn Off Base Currents

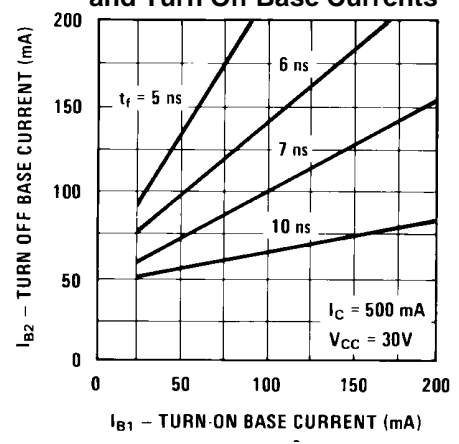

NPN Switching Transistor
(continued)

AC Typical Characteristics (continued)

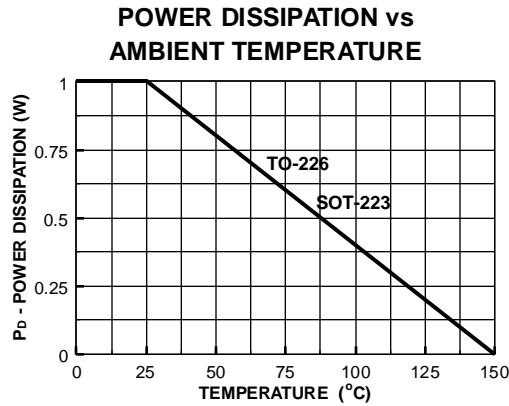
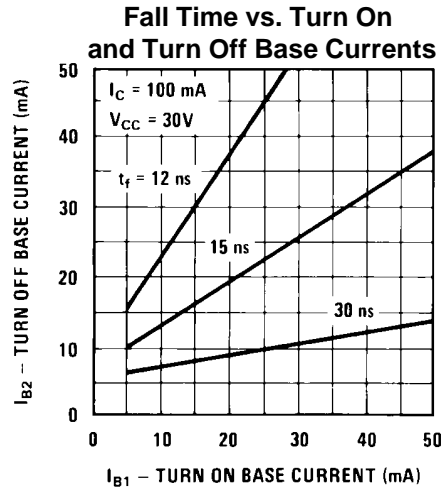
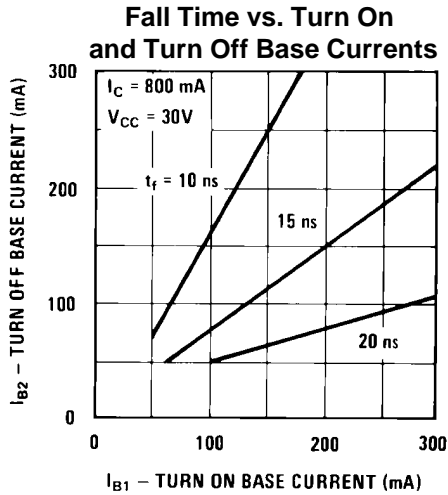

Test Circuit

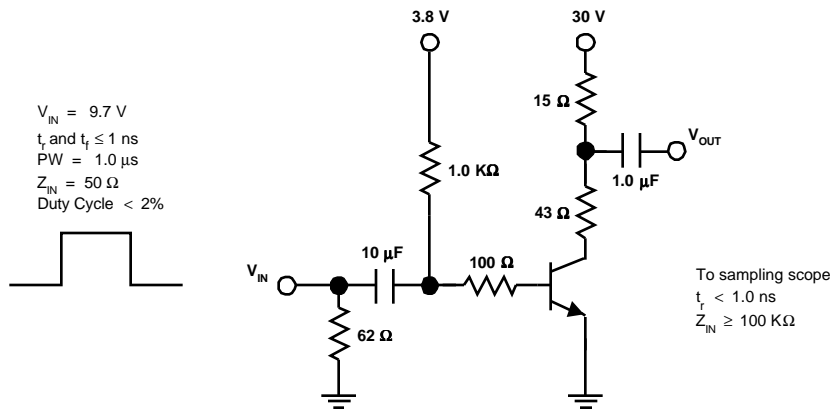

FIGURE 1: Switching Time Test Circuit
($I_C = 500 \text{ mA}$, $I_{B1} = 50 \text{ mA}$, $I_{B2} = 50 \text{ mA}$)