

HEXFET[®] Power MOSFET

- Dynamic dv/dt Rating
- Repetitive Avalanche Rated
- For Automatic Insertion
- End Stackable
- Fast Switching
- Ease of paralleling
- Simple Drive Requirements

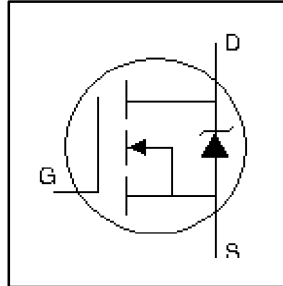

$V_{DSS} = 400V$
$R_{DS(on)} = 1.8\Omega$
$I_D = 0.49A$

Description

Third Generation HEXFETs from International Rectifier provide the designer with the best combination of fast switching, ruggedized device design, low on-resistance and cost-effectiveness.

The 4-pin DIP package is a low-cost machine-insertable case style which can be stacked in multiple combinations on standard 0.1 inch pin centers. The dual drain serves as a thermal link to the mounting surface for power dissipation levels up to 1 watt.

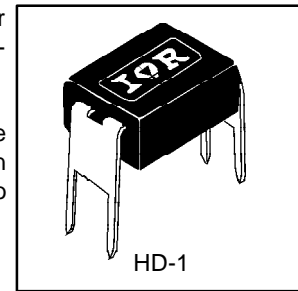

Absolute Maximum Ratings

	Parameter	Max.	Units
$I_D @ T_C = 25^\circ C$	Continuous Drain Current, $V_{GS} @ 10 V$	0.49	A
$I_D @ T_C = 100^\circ C$	Continuous Drain Current, $V_{GS} @ 10 V$	0.31	
I_{DM}	Pulsed Drain Current ①	3.9	
$P_D @ T_C = 25^\circ C$	Power Dissipation	1.0	W
	Linear Derating Factor	0.0083	W/°C
V_{GS}	Gate-to-Source Voltage	± 20	V
E_{AS}	Single Pulse Avalanche Energy ②	48	mJ
I_{AR}	Avalanche Current ①	0.49	A
E_{AR}	Repetitive Avalanche Energy ①	0.10	mJ
dv/dt	Peak Diode Recovery dv/dt ③	4.0	V/ns
T_J	Operating Junction and	-55 to + 150	°C
T_{STG}	Storage Temperature Range		
	Soldering Temperature, for 10 seconds	300 (1.6mm from case)	

Thermal Resistance

	Parameter	Min.	Typ.	Max.	Units
$R_{\theta JA}$	Junction-to-Ambient	—	—	120	°C/W

Electrical Characteristics @ $T_J = 25^\circ\text{C}$ (unless otherwise specified)

	Parameter	Min.	Typ.	Max.	Units	Conditions
$V_{(BR)DSS}$	Drain-to-Source Breakdown Voltage	400	—	—	V	$V_{GS} = 0V, I_D = 250\mu\text{A}$
$\Delta V_{(BR)DSS}/\Delta T_J$	Breakdown Voltage Temp. Coefficient	—	0.51	—	V/ $^\circ\text{C}$	Reference to 25°C , $I_D = 1\text{mA}$
$R_{DS(on)}$	Static Drain-to-Source On-Resistance	—	—	1.8	Ω	$V_{GS} = 10.0V, I_D = 0.21A$ ④
		—	—	—		$V_{GS} = V, I_D = A$ ④
$V_{GS(th)}$	Gate Threshold Voltage	2.0	—	4.0	V	$V_{DS} = V_{GS}, I_D = 250\mu\text{A}$
g_{fs}	Forward Transconductance	1.7	—	—	S	$V_{DS} = 50V, I_D = 1.2A$
I_{DSS}	Drain-to-Source Leakage Current	—	—	25	μA	$V_{DS} = 400V, V_{GS} = 0V$
		—	—	250		$V_{DS} = 320V, V_{GS} = 0V, T_J = 125^\circ\text{C}$
I_{GSS}	Gate-to-Source Forward Leakage	—	—	100	nA	$V_{GS} = 20V$
	Gate-to-Source Reverse Leakage	—	—	-100		$V_{GS} = -20V$
Q_g	Total Gate Charge	—	—	20	nC	$I_D = 2.0A$
Q_{gs}	Gate-to-Source Charge	—	—	3.3		$V_{DS} = 320V$
Q_{gd}	Gate-to-Drain ("Miller") Charge	—	—	11		$V_{GS} = 10V$, See Fig. 6 and 13 ④
$t_{d(on)}$	Turn-On Delay Time	—	10	—		$V_{DD} = 200V$
t_r	Rise Time	—	14	—	ns	$I_D = 3.3A$
$t_{d(off)}$	Turn-Off Delay Time	—	30	—		$R_G = 18\Omega$
t_f	Fall Time	—	13	—		$R_D = 56\Omega$, See Fig. 10 ④
L_D	Internal Drain Inductance	—	4.0	—	nH	Between lead, 6mm (0.25in.) from package and center of die contact
L_S	Internal Source Inductance	—	6.0	—		
C_{iss}	Input Capacitance	—	410	—	pF	$V_{GS} = 0V$
C_{oss}	Output Capacitance	—	120	—		$V_{DS} = 25V$
C_{riss}	Reverse Transfer Capacitance	—	47	—		$f = 1.0\text{MHz}$, See Fig. 5



Source-Drain Ratings and Characteristics

	Parameter	Min.	Typ.	Max.	Units	Conditions
I_S	Continuous Source Current (Body Diode)	—	—	0.49	A	MOSFET symbol showing the integral reverse p-n junction diode.
I_{SM}	Pulsed Source Current (Body Diode) ①	—	—	3.9		
V_{SD}	Diode Forward Voltage	—	—	1.6	V	$T_J = 25^\circ\text{C}, I_S = 0.49A, V_{GS} = 0V$ ②
t_{rr}	Reverse Recovery Time	—	270	600	ns	$T_J = 25^\circ\text{C}, I_F = 3.3A$
Q_{rr}	Reverse Recovery Charge	—	1.4	3.0	μC	$di/dt = 100A/\mu\text{s}$ ②
t_{on}	Forward Turn-On Time	Intrinsic turn-on time is negligible (turn-on is dominated by L_S+L_D)				

Notes:

① Repetitive rating; pulse width limited by max. junction temperature. (See fig. 11)

③ $I_{SD} \leq 2.0A, di/dt \leq 40A/\mu\text{s}, V_{DD} \leq V_{(BR)DSS}, T_J \leq 150^\circ\text{C}$

② $V_{DD} = 50V$, starting $T_J = 25^\circ\text{C}$, $L = 21\text{mH}$, $R_G = 25\Omega, I_{AS} = 2.0A$. (See Figure 12)

④ Pulse width $\leq 300\mu\text{s}$; duty cycle $\leq 2\%$.

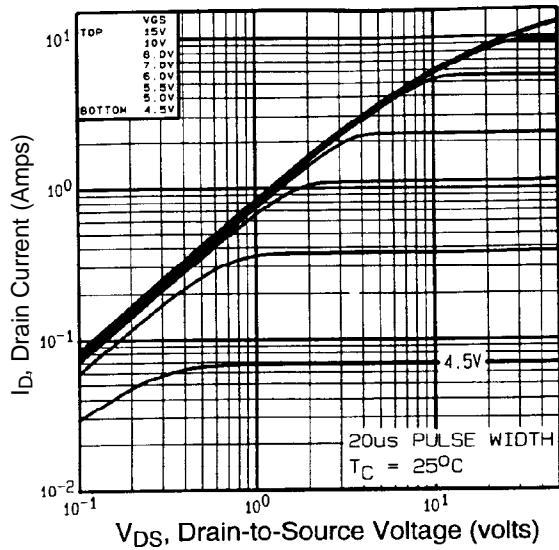

Fig 1. Typical Output Characteristics,
 $T_C = 25^\circ\text{C}$

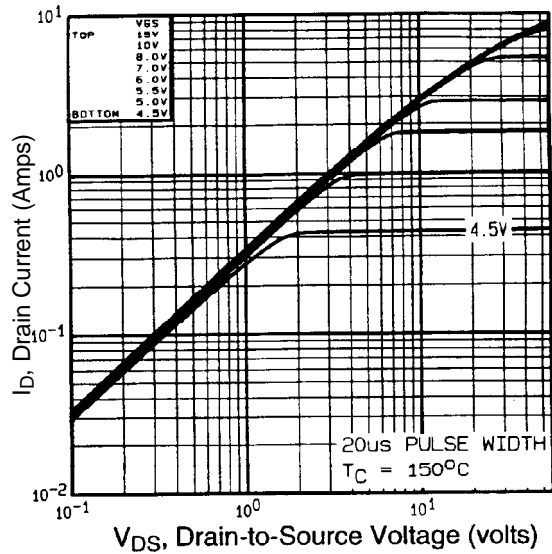

Fig 2. Typical Output Characteristics,
 $T_C = 150^\circ\text{C}$

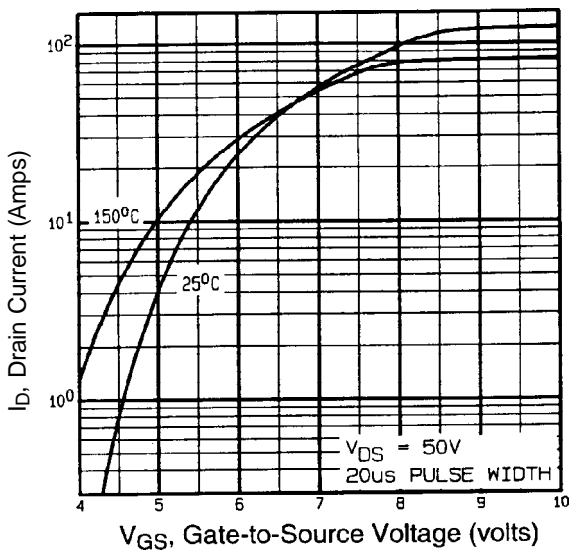

Fig 3. Typical Transfer Characteristics

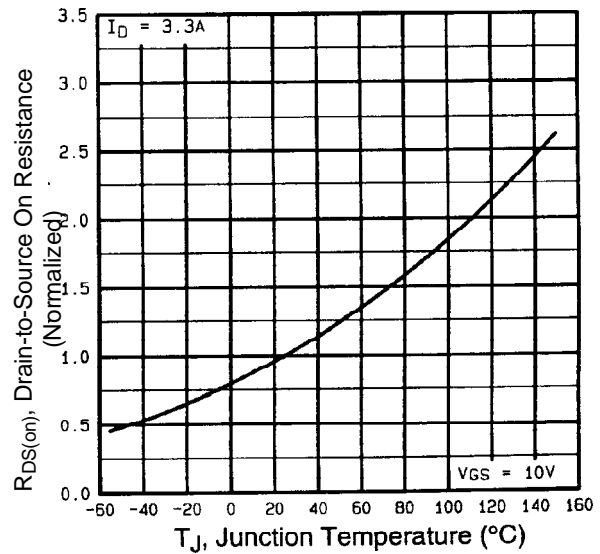

Fig 4. Normalized On-Resistance
 Vs. Temperature

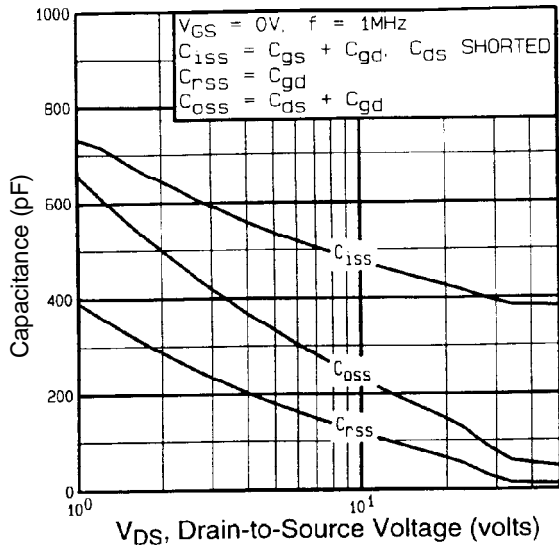

Fig 5. Typical Capacitance Vs. Drain-to-Source Voltage

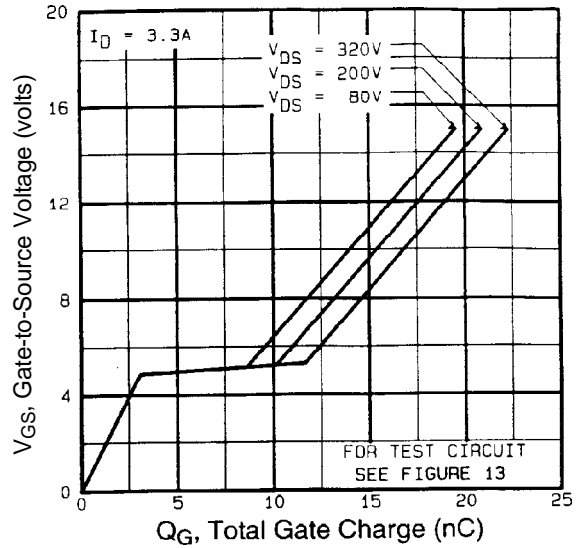

Fig 6. Typical Gate Charge Vs. Gate-to-Source Voltage

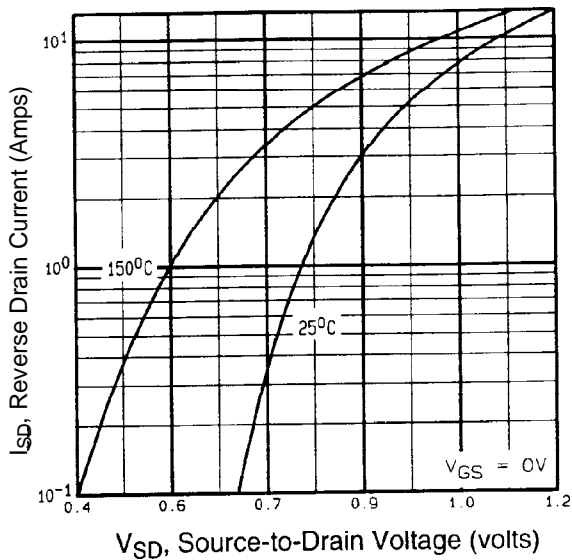

Fig 7. Typical Source-Drain Diode Forward Voltage

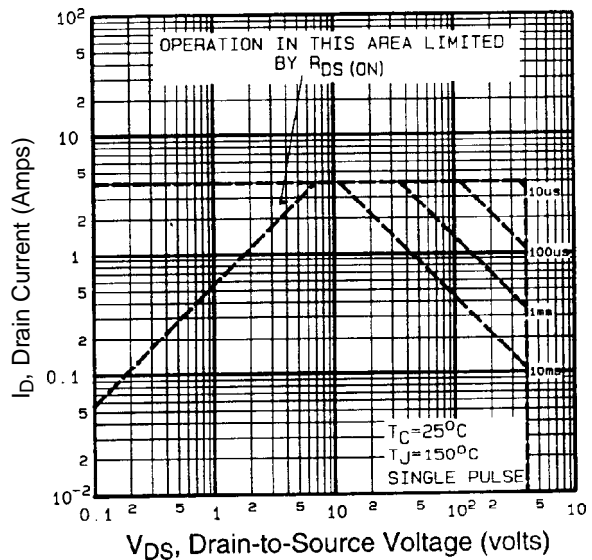

Fig 8. Maximum Safe Operating Area

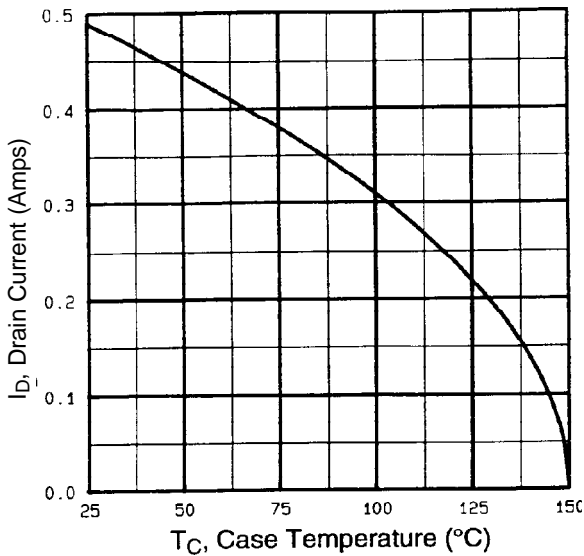

Fig 9. Maximum Drain Current Vs. Case Temperature

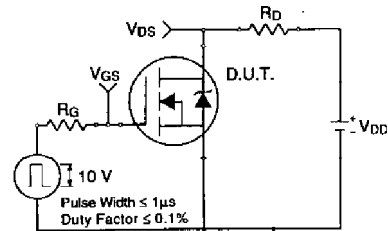

Fig 10a. Switching Time Test Circuit

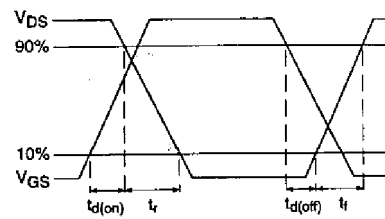

Fig 10b. Switching Time Waveforms

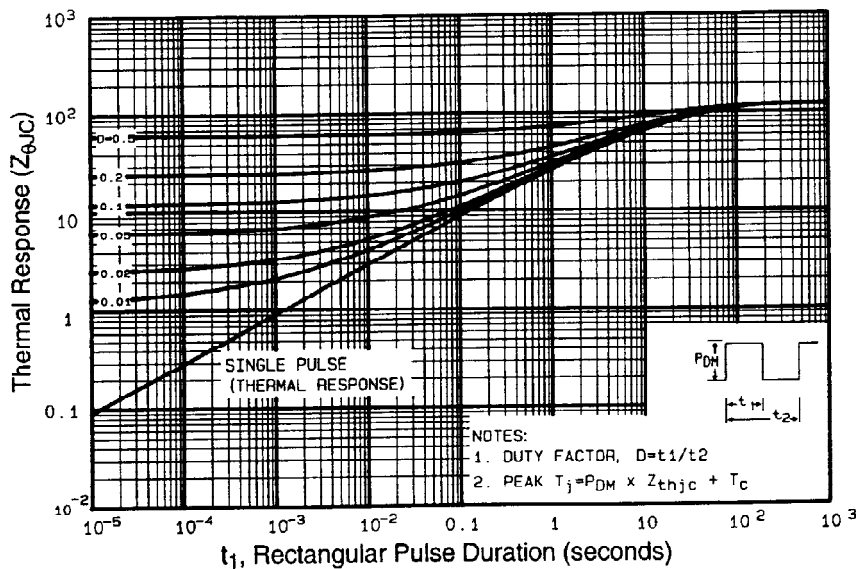

Fig 11. Maximum Effective Transient Thermal Impedance, Junction-to-Case

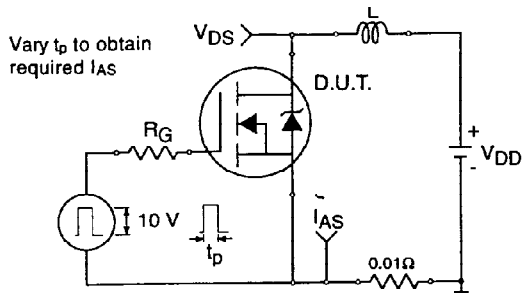

Fig 12a. Unclamped Inductive Test Circuit

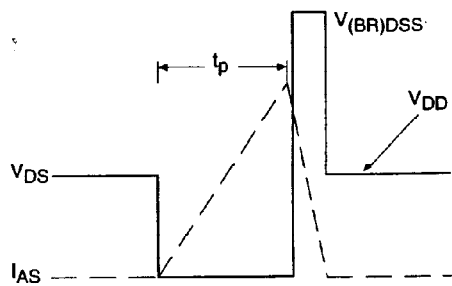

Fig 12b. Unclamped Inductive Waveforms

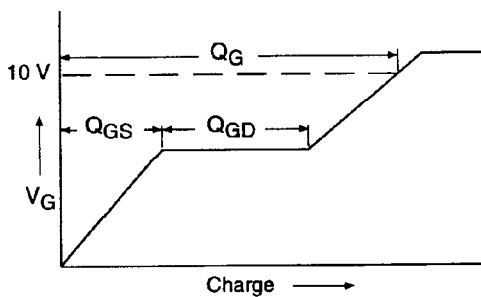

Fig 13a. Basic Gate Charge Waveform

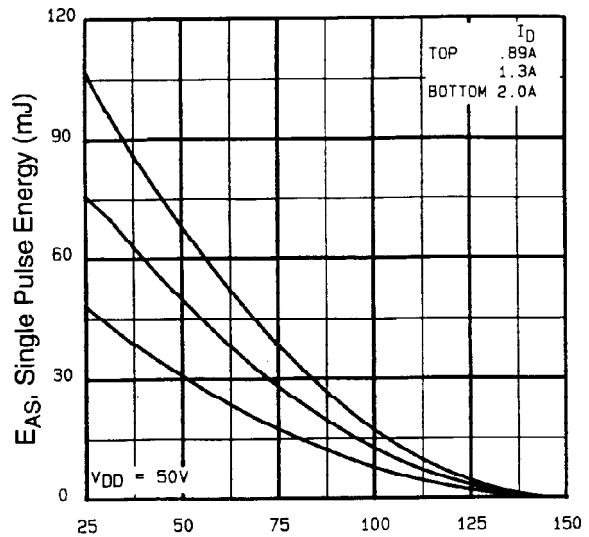

Fig 12c. Maximum Avalanche Energy Vs. Drain Current

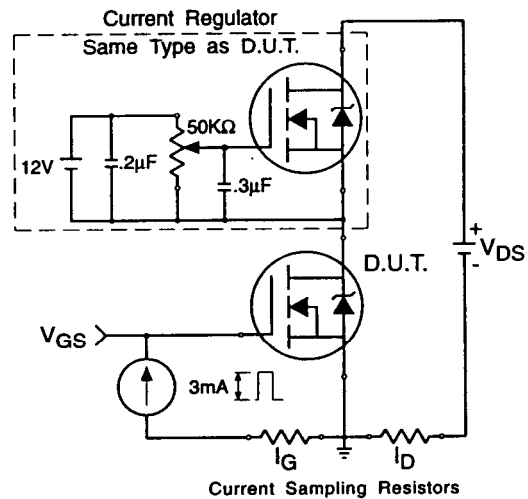
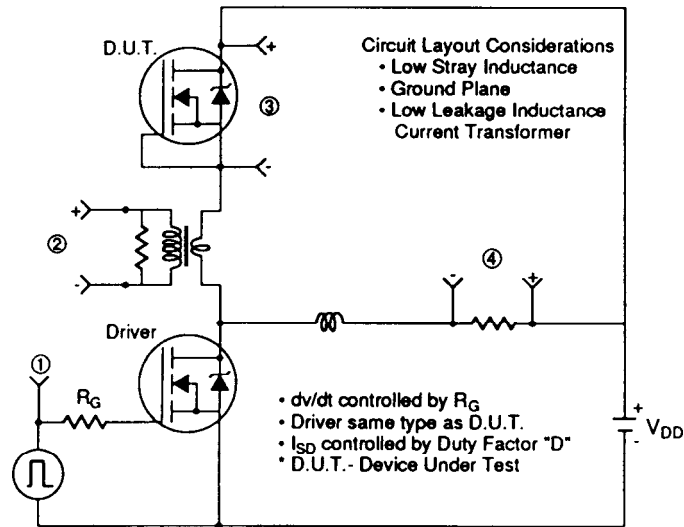

Fig 13b. Gate Charge Test Circuit

dv/dt Test Circuit

Fig 14. For N-Channel HEXFETs



Peak Diode Recovery Test Circuit

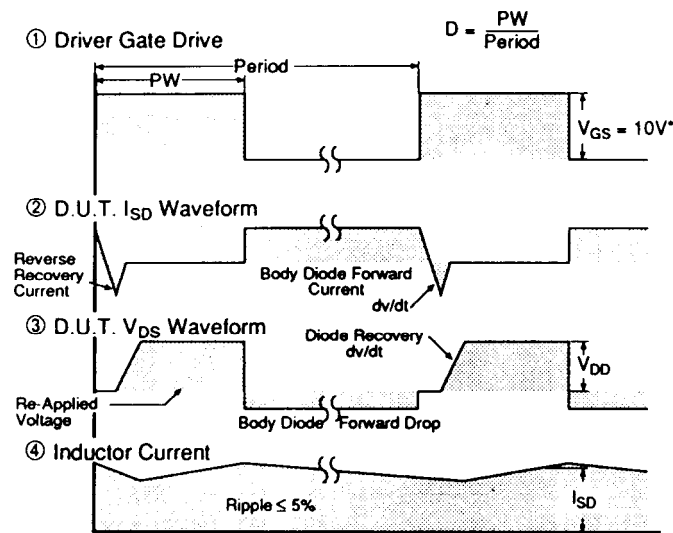

* $V_{GS} = 5V$ for Logic Level Devices

IRFD320



Package Outline

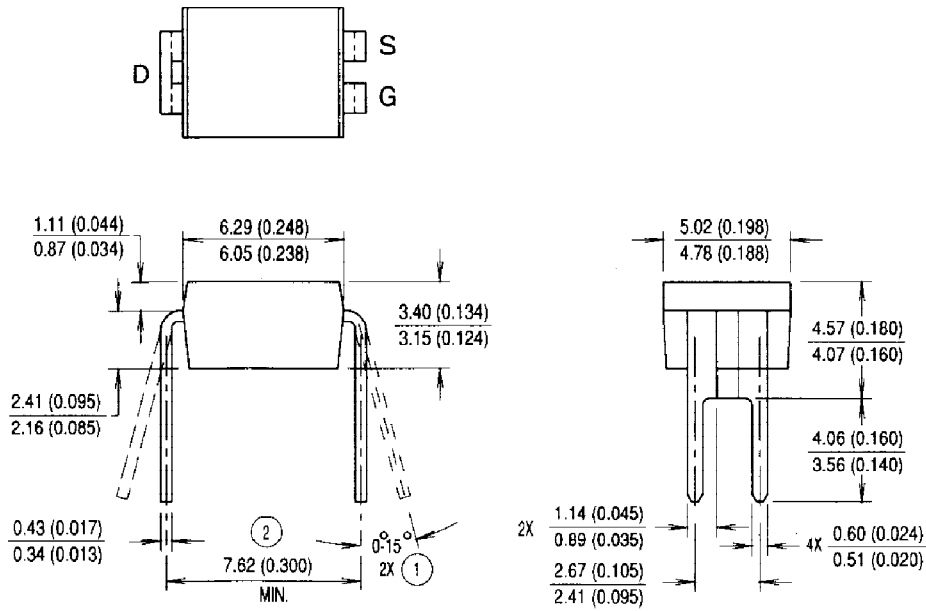

International
IOR Rectifier

WORLD HEADQUARTERS: 233 Kansas St., El Segundo, California 90245, Tel: (310) 322 3331
EUROPEAN HEADQUARTERS: Hurst Green, Oxted, Surrey RH8 9BB, UK Tel: (44) 0883 713215
IR CANADA: 7321 Victoria Park Ave., Suite 201, Markham, Ontario L3R 3L1, Tel: (905) 475 1897 **IR GERMANY:** Saalburgstrasse 157, 61350 Bad Homburg Tel: 6172 37066 **IR ITALY:** Via Liguria 49, 10071 Borgaro, Torino Tel: (39) 1145 10111 **IR FAR EAST:** K&H Bldg., 2F, 3-30-4 Nishi-Ikeburo 3-Chome, Toshima-Ki, Tokyo 171 Tel: (03)3983 0641
IR SOUTHEAST ASIA: 315 Outram Road, #10-02 Tan Boon Liat Building, 0316 Tel: 65 221 8371

Data and specifications subject to change without notice.