

SANYO

No.4454A

LC8390M**16bits A/D and D/A Converters
for Digital Audio Systems****Overview**

The LC8390M combines two-channel D/A and A/D converters in a single chip.

Features

- A/D Converter Block
 - Quadratic $\Delta\Sigma$ modulation
 - 16bit resolution
 - Built-in aliasing noise prevention digital filter
 - A/D converters for two channels built in (synchronized input when standard audio output is used)
 - S/N = 80 dB, THD + N = 0.025% (typical, A-compensation filter used)
 - Digital output: MSB first, forward packed, bit clock rates of 32, 48, and 64 Fs
 - External integrator used.
- D/A Converter Block
 - 16x oversampling quadratic noise shaper + PWM
 - 16bits resolution
 - D/A converters for two channels built in (synchronized output)
 - S/N = 85 dB, THD + N = 0.03% (typical, A-compensation filter used)
 - Digital input: MSB first, backward packed, bit clock rates of 32, 48, and 64 Fs
 - Digital oversampling filters are not built in.
- Built-in double-buffering serial I/O circuits. (These circuits support both standard audio I/O and I/O with arbitrary timing.)
- Sampling frequencies of 48, 44.1, and 32 kHz

- Master clock: 512 Fs (24.576 MHz when fs = 48 kHz) or 384 Fs

Notes: Only the A/D converters operate when 384 Fs is selected as the master clock. The D/A converters do not operate in this mode.

Since the analog I/F and analog power supply pins are more susceptible to damage from static electricity than the other pins, extra care is required.

Analog I/F pins: DZOUTL, ADL2, ADLV_{SS}, ADLV_{DD}, ADL3, DZOUTR, ADR2, ADRV_{SS}, ADRV_{DD}, ADR3, DALV_{SS}, PWML, DALV_{DD}, DARV_{SS}, PWMR, DARV_{DD}

- Package: 30-pin MFP
- Power supply: 5 V, single voltage, CMOS

Package Dimensions

unit: mm

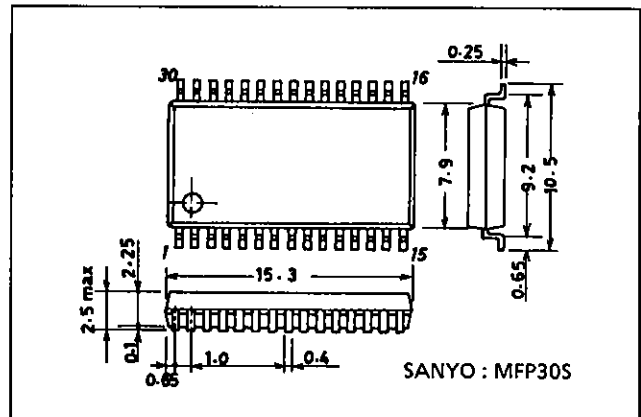
3073A-MFP30S**SANYO Electric Co., Ltd. Semiconductor Business Headquarters**

TOKYO OFFICE Tokyo Bldg., 1-10, 1 Chome, Ueno, Taito-ku, TOKYO, 110 JAPAN

LC8390M

Pin Asslgment

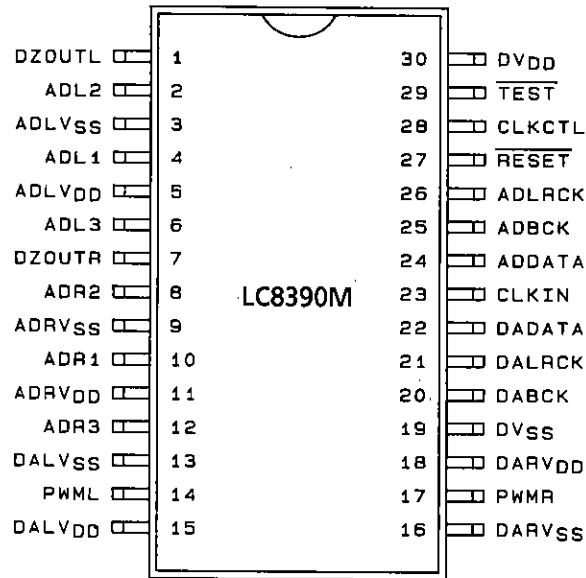

Top view

A01415

Block Diagram

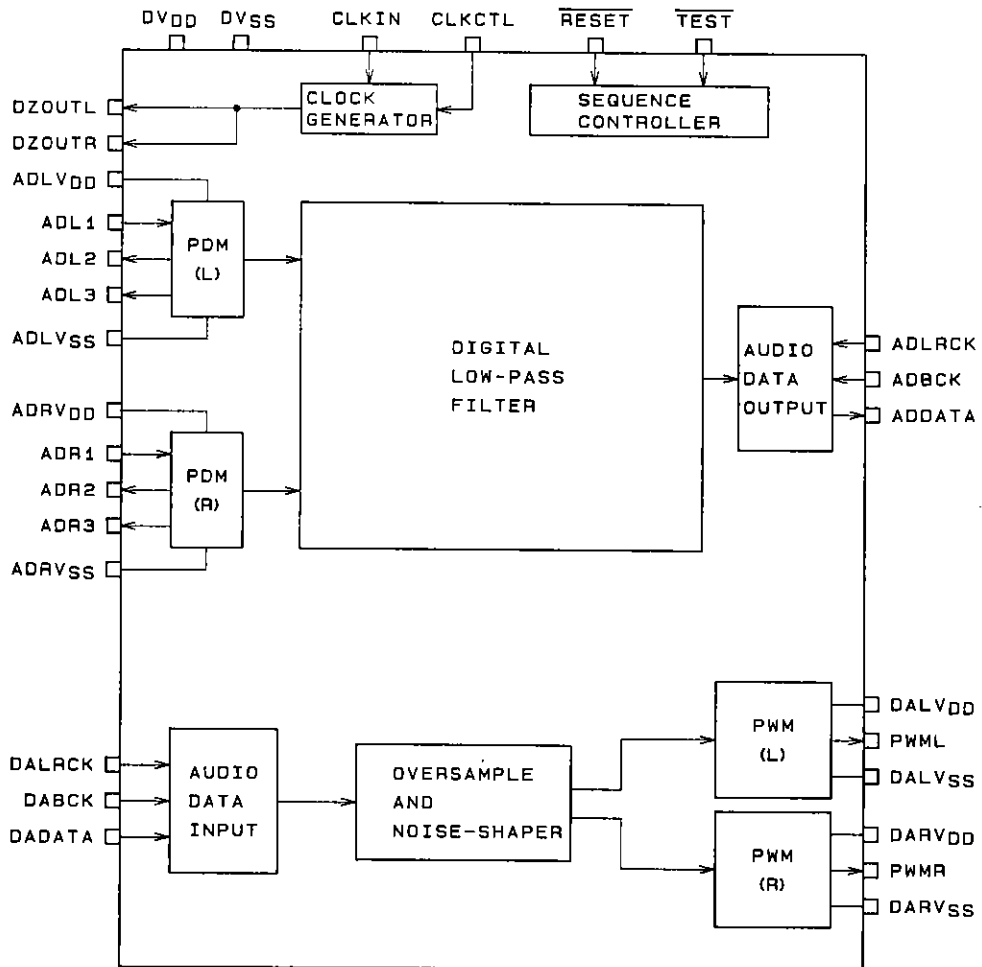

A01416

Pin Functions

Block	Pin No.	Pin	I/O	Function
A/D block	5	ADLV _{DD}	—	Analog left channel A/D power supply
	3	ADLV _{SS}	—	Analog left channel A/D ground
	4	ADL1	I	Left channel A/D audio input
	2	ADL2	O	Left channel A/D linear $\Delta\Sigma$ output
	6	ADL3	O	Left channel A/D quadratic $\Delta\Sigma$ output
	11	ADRV _{DD}	—	Analog right channel A/D power supply
	9	ADRV _{SS}	—	Analog right channel A/D ground
	10	ADR1	I	Right channel A/D audio input
	8	ADR2	O	Right channel A/D linear $\Delta\Sigma$ output
	12	ADR3	O	Right channel A/D quadratic $\Delta\Sigma$ output
	26	ADLRCK	I	A/D left and right channel clock input
	25	ADBCK	I	A/D bit clock input
	24	ADDATA	O	A/D data output
	1	DZOUTL	O	A/D dithering clock output
7	DZOUTR	O	A/D dithering clock output	
D/A block	15	DALV _{DD}	—	Analog left channel D/A power supply
	13	DALV _{SS}	—	Analog left channel D/A ground
	14	PWML	O	Left channel D/A PWM output
	18	DARV _{DD}	—	Analog right channel D/A power supply
	16	DARV _{SS}	—	Analog right channel D/A ground
	17	PWMR	O	Right channel D/A PWM output
	21	DALRCK	I	D/A left and right channel clock input
	20	DABCK	I	D/A bit clock input
22	DADATA	I	D/A data input	
Control and other pins	30	DV _{DD}	—	Digital system power supply
	19	DV _{SS}	—	Digital system ground
	23	CLKIN	I	Master clock input
	28	CLKCTL	I	Master clock selection (high: 512 Fs, low: 384 Fs)
	27	RESET	I	Reset input
	29	TEST	I	Test input. (This pin must be connected to DV _{DD} during normal operation.)

LC8390M

Pin Types

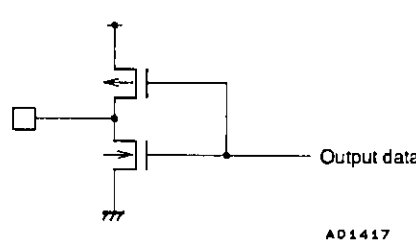
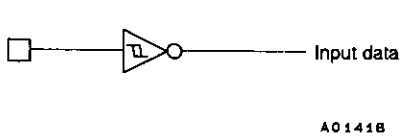
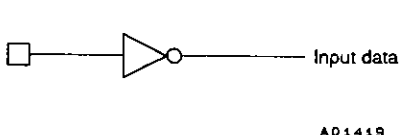
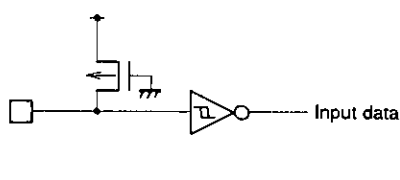
Specification	Circuit	Pin
TTL output	 <p style="text-align: right;">Output data</p> <p style="text-align: center;">A01417</p>	ADDATA
Analog output		PWML, PWMR
		ADL2, ADL3, DZOUTL, ADR2, ADR3, DZOUTR
Schmitt input	 <p style="text-align: right;">Input data</p> <p style="text-align: center;">A01418</p>	TEST, CLKCTL, ADLRCK, ADBCK, CLKIN, DADATA, DALRCK, DABCK
Analog input	 <p style="text-align: right;">Input data</p> <p style="text-align: center;">A01419</p>	ADL1, ADR1
Built-in pull-up resistor input	 <p style="text-align: right;">Input data</p> <p style="text-align: center;">A01420</p>	RESET

Specifications

Absolute Maximum Ratings at $T_a = 25^\circ\text{C}$, $V_{SS} = 0\text{ V}$

Parameter	Symbol	Conditions	Ratings	Unit
Maximum supply voltage	$V_{DD\text{ max}}$		-0.3 to +7.0	V
Maximum output voltage	$V_O\text{ max}$		-0.3 to $V_{DD} + 0.3$	V
Maximum input voltage	$V_{IN\text{ max}}$		-0.3 to $V_{DD} + 0.3$	V
Allowable power dissipation	$P_d\text{ max}$	$T_a = -30\text{ to }+70^\circ\text{C}$	200	mW
Operating temperature	T_{opr}		-30 to +70	$^\circ\text{C}$
Storage temperature	T_{stg}		-40 to +125	$^\circ\text{C}$

Allowable Operating Ranges

at Ta = -30 to 70°C, all V_{DD} = 4.75 to 5.5 V, all V_{SS} = 0 V unless otherwise specified

Parameter		Symbol	Conditions	Ratings			Unit
				min	typ	max	
Operating supply voltage		V _{DD}	All V _{DD} pins*2	4.75		5.5	V
Input high level voltage		V _{IH}	Schmitt inputs, built-in pull-up resistor inputs*1	0.75 V _{DD}			V
Input low level voltage		V _{IL}	Schmitt inputs, built-in pull-up resistor inputs*1			0.25 V _{DD}	V
External clock input conditions	Frequency	f _{EXT}	CLKIN: See figure 1.	12.16		24.83	MHz
	Pulse width	t _{EXTH} t _{EXTL}		16			ns
	Rise and fall times	t _{EXTR} t _{EXTF}				9	ns
RESET low level input pulse width		t _{RES}	RESET: See figure 2.	15 cycles of the CLKIN input clock			
Transfer clock input conditions	Transfer bit clock period	t _{BCYC}	ADBACK, DABCK, ADLRCK, and DALRCK: See figures 3 and 4.	325			ns
	Transfer bit clock pulse width	t _{BCW}		100			ns
	Transfer bit clock setup time	t _{BCS}				70	ns
	Transfer bit clock hold time	t _{BCH}				70	ns
D/A converter data input conditions	Data setup time	t _{DS}	DABCK and DADATA: See figure 3.	70			ns
	Data hold time	t _{DH}		70			ns

Note 1: TEST, CLKCTL, ADLRCK, ADBCK, CLKIN, DADATA, DALRCK, DABCK, RESET

2: Apply the same voltage to the DV_{DD}, ADLV_{DD}, ADRV_{DD}, DALV_{DD} and DARV_{DD} pins.

Electrical Characteristics 1 at Ta = 25°C, all V_{DD} = 5.0 V, all V_{SS} = 0 V unless otherwise specified

Parameter		Symbol	Conditions	Ratings			Unit
				min	typ	max	
A/D block	Total harmonic distortion	A-THD	At 1 kHz and 0 dB*		0.025		%
	Signal-to-noise ratio	A-S/N	At 1 kHz and 0 dB*		80		dB
	Crosstalk	A-C-T	At 1 kHz and 0 dB*		-78		dB
D/A block	Total harmonic distortion	D-THD	At 1 kHz and -1 dB*		0.03		%
	Signal-to-noise ratio	D-S/N	At 1 kHz and -1 dB*		85		dB
	Crosstalk	D-C-T	At 1 kHz and -1 dB*		-83		dB

Note: * A-compensation filter used, Fs = 48 kHz, and testing is performed using the Sanyo supplied evaluation board.

Electrical Characteristics 2

at Ta = -30 to 70°C, all V_{DD} = 4.75 to 5.5 V, all V_{SS} = 0 V unless otherwise specified

Parameter		Symbol	Conditions	Ratings			Unit
				min	typ	max	
Input low level current		I _{IL}	RESET (built-in pull-up resistor inputs): V _{IN} = V _{SS}	-250			μA
Output high level voltage		V _{OH}	ADDATA: I _{OH} = -0.4 mA	4.0			V
Output low level voltage		V _{OL}	ADDATA: I _{OL} = 2 mA			0.4	V
Input leakage current		I _{LK}	Schmitt inputs: V _{IN} = V _{SS} , V _{DD}	-10		+10	μA
Input and output capacitance		C _{IO}				10	pF
Data output timing	Data hold time	t _{OH}	ADDATA: See figure 5.	0			ns
	Data delay time	t _{OD}				50	ns
Current dissipation		I _{DD}	DV _{DD}		7	14	mA
			The sum of ADLV _{DD} , ADRV _{DD} , DALV _{DD} and DARV _{DD} .		8	16	mA

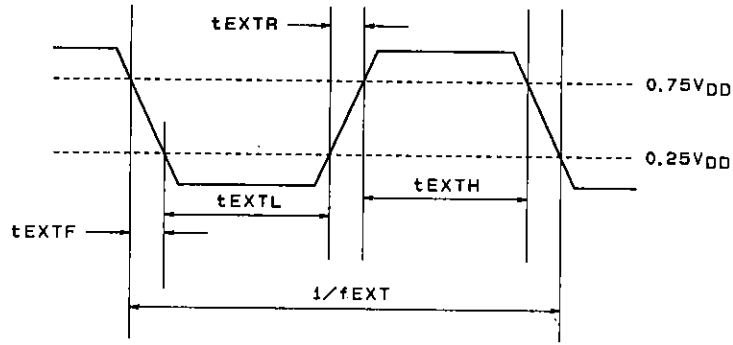

A01421

Figure 1 External Clock Input Waveform (CLKIN)

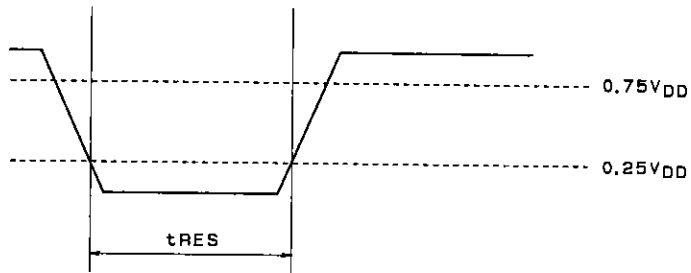

A01422

Figure 2 $\overline{\text{RESET}}$ Input Waveform

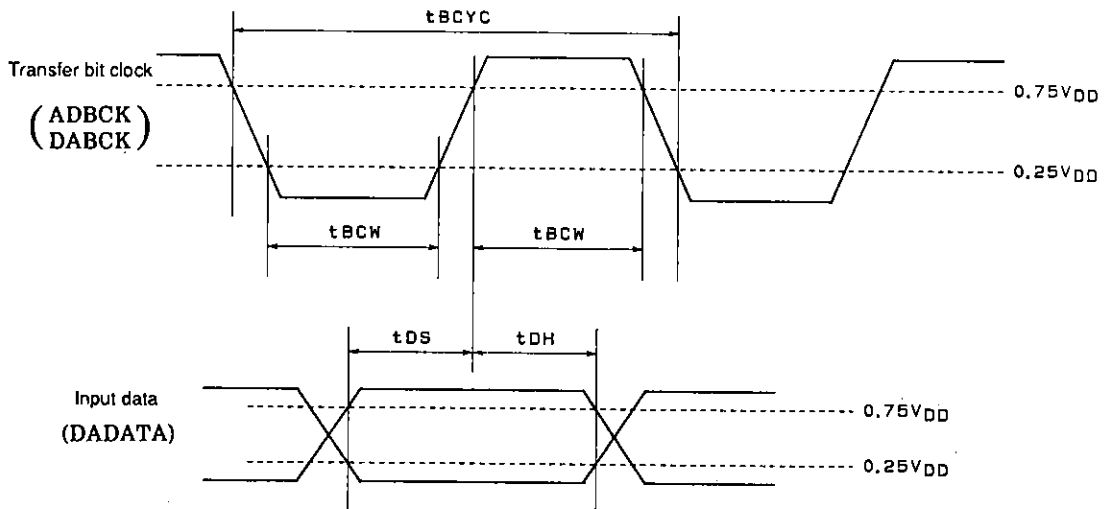

A01423

Figure 3 Audio Data Input Conditions

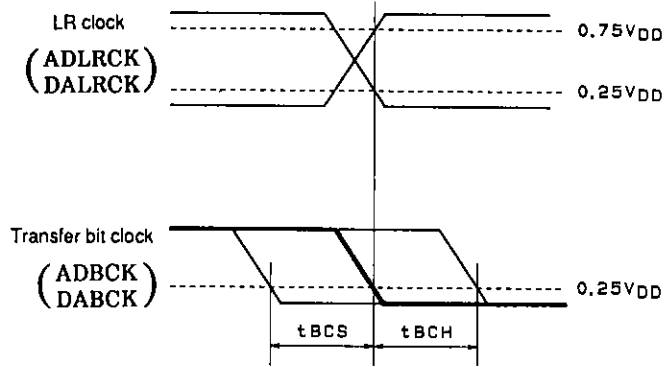

A01424

Figure 4 Audio Clock Input Conditions

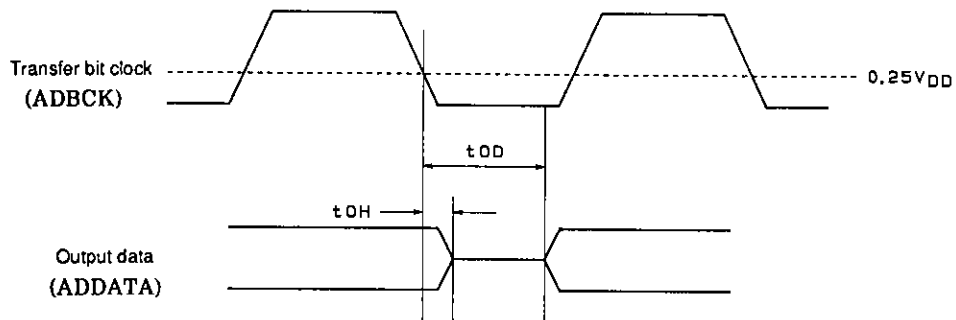

A01425

Figure 5 Audio Data Output Timing

Master Clock Setting

Set the CLKCTL pin to match the oscillator frequency as shown in the table below.

Oscillator frequency	CLKCTL
512 Fs	H
384 Fs	L

Only the A/D converters operate when 384 Fs is selected. The D/A converters do not operate in this mode.

A/D Data Output Format

Always use the standard audio output mode when using this LSI in audio applications.

■ No products described or contained herein are intended for use in surgical implants, life-support systems, aerospace equipment, nuclear power control systems, vehicles, disaster/crime-prevention equipment and the like, the failure of which may directly or indirectly cause injury, death or property loss.

■ Anyone purchasing any products described or contained herein for an above-mentioned use shall:

- ① Accept full responsibility and indemnify and defend SANYO ELECTRIC CO., LTD., its affiliates, subsidiaries and distributors and all their officers and employees, jointly and severally, against any and all claims and litigation and all damages, cost and expenses associated with such use:
- ② Not impose any responsibility for any fault or negligence which may be cited in any such claim or litigation on SANYO ELECTRIC CO., LTD., its affiliates, subsidiaries and distributors or any of their officers and employees jointly or severally.

■ Information (including circuit diagrams and circuit parameters) herein is for example only; it is not guaranteed for volume production. SANYO believes information herein is accurate and reliable, but no guarantees are made or implied regarding its use or any infringements of intellectual property rights or other rights of third parties.

Standard Audio Output

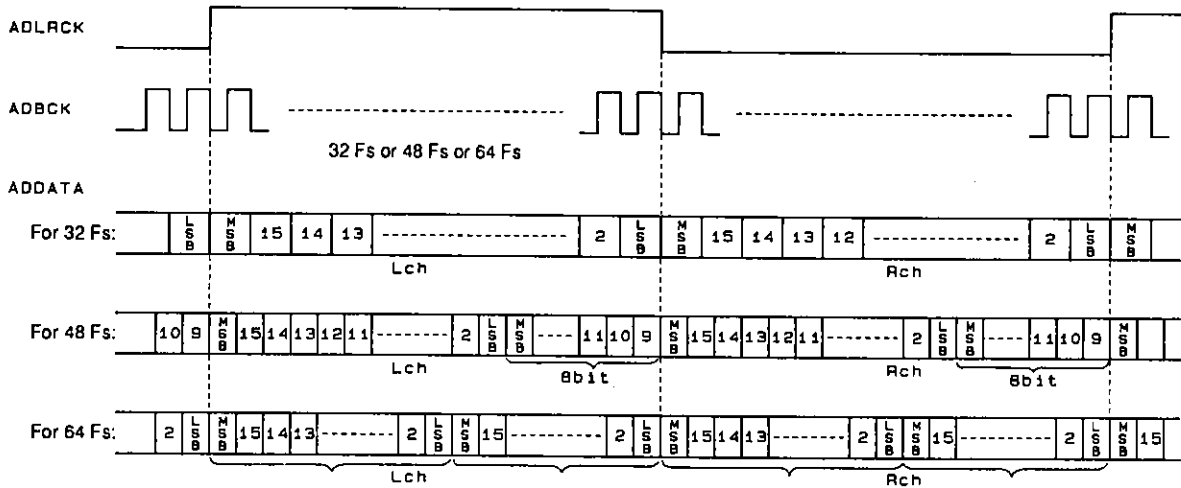

Arbitrary Timing Output

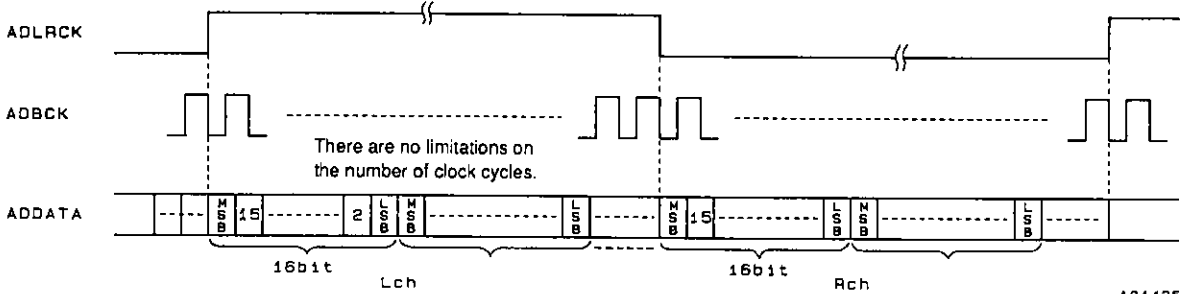

A01425

The output data pin (ADDATA) holds the left channel data when ADLRCK rises, and continues to output this value while ADLRCK remains high. Similarly, the right channel data is held when ADLRCK falls, and this value is output while ADLRCK remains low.

D/A Data Input Format

Always use the standard audio input mode when using this LSI in audio applications.

Standard Audio Input

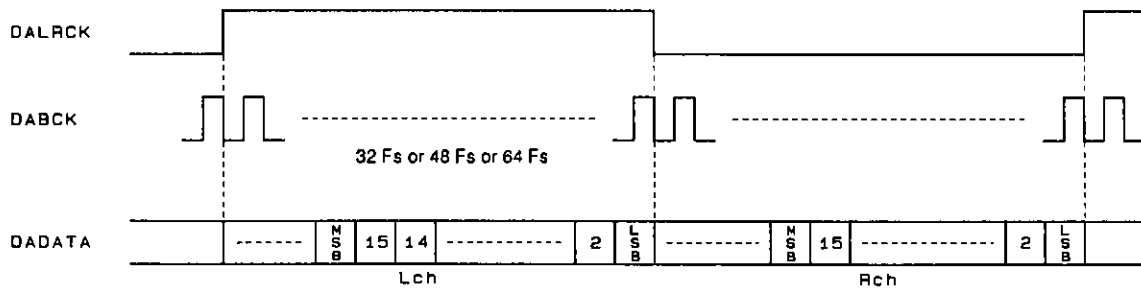

Arbitrary Timing Input

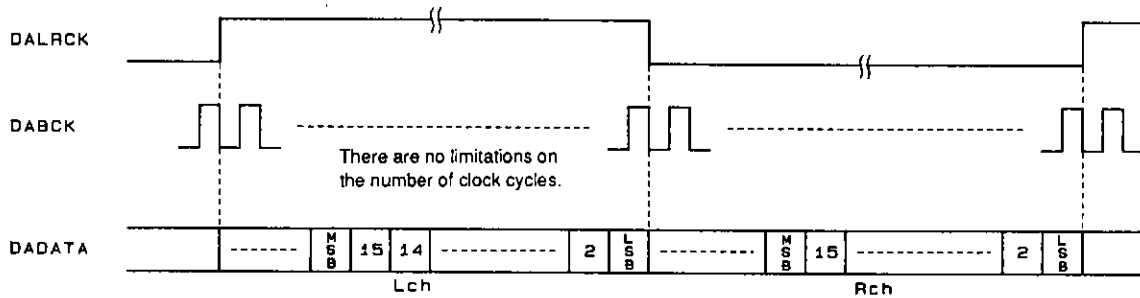

A01427

The previous 16 bits of input data are valid on the rise or fall of DALRCK.

A/D Digital Filter Frequency Response (theory values, $f_s = 48$ kHz)

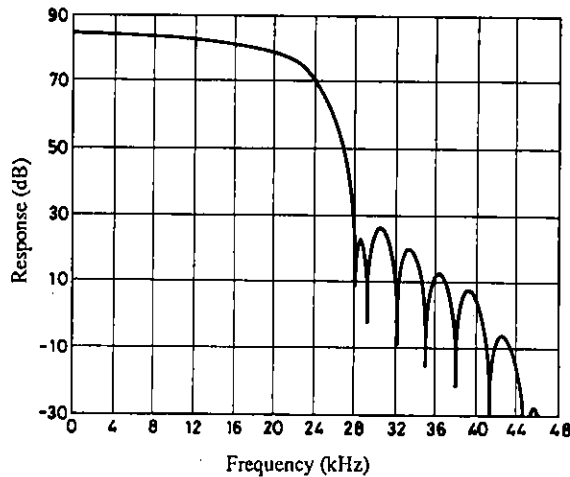

Operating Principles

1. A/D Converter Block

The A/D converter block in this IC is a 2-channel 16-bit A/D converter that uses a quadratic $\Delta\Sigma$ modulation technique. The circuit includes two built-in $\Delta\Sigma$ modulators (although an external integrator is used), and the analog input signals are simultaneously sampled at a 128 \times sampling rate. The oversampled data is decimated using a digital filter. The output data is serial signed 16-bit two's complement data. When standard audio output is used, simultaneously sampled data is output. When arbitrary timing is used, left channel data is output on the rise of ADLRCK, and right channel data is output on the fall of ADLRCK.

2. D/A Converter Block

The D/A converter block in this IC is a 2-channel 16-bit D/A converter that combines a quadratic noise shaper and PWM (pulse width modulation) techniques. Two PWM generators are built in, and quadratic noise shaping is applied to the data, which is oversampled by holding the previous value (note that digital filters are not built in), and output from the left and right channels at the same time. Input data is serial signed 16-bit two's complement data. Since digital oversampling filters are not built in, steep external low-pass filters (LPF) are required. Input data is acquired on the rising edge of DALRCK for both standard audio input and arbitrary timing input modes. Data is output from the PWM generators at the same time from the left and right channels.

3. Initialization

The LC8390M must be initialized after power is applied and when the sampling period changes. To initialize the LC8390M, once the power supply voltage has stabilized and CLKIN has been supplied, a low level must be input to the $\overline{\text{RESET}}$ pin for a period longer than 15 CLKIN cycles.

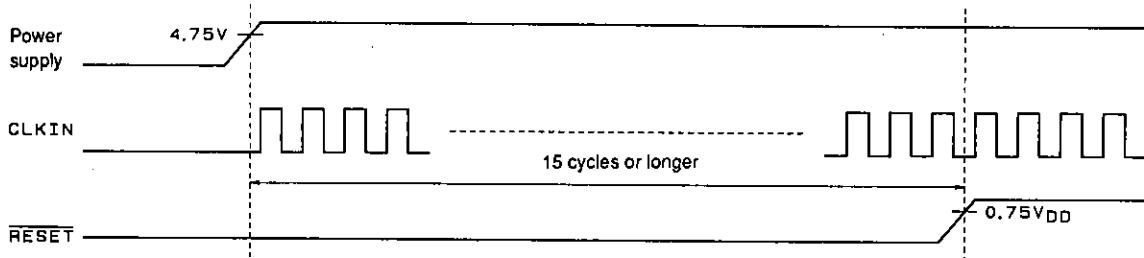

A0142B

Design and Usage Notes

1. External Clock

The CLKIN must not be stopped during operation. If this clock is not supplied, overcurrents may occur since dynamic logic is used internally, and the LC8390M may function abnormally. This IC must synchronize its internal operating timing with the externally supplied ADLRCK and DALRCK. This synchronization is performed by resetting an internal counter. This reset is only performed a few times on the rising edges of ADLRCK and DALRCK following initialization by a $\overline{\text{RESET}}$ pin input. Therefore, the CLKIN, ADLRCK, ADBCK, DALRCK and DABCK clock inputs must be synchronized. However, CLKIN and other clocks do not have to be synchronized for arbitrary timing input and output. Clock jitter will degrade A/D and D/A converter precision in this IC. The wiring lines for the master clock must be kept as short as possible, and a crystal oscillator signal level clock should be used.

2. Power Supply and Ground

Use care in supplying power and ground to this IC. Separate the analog and digital blocks, and provide a separate ground plane for each. Connect the analog and digital grounds to points near the power supply on the PC board. While DV_{DD} is the power supply for the internal logic circuits, since DV_{DD} and the analog system V_{DD} supplies (ADLV_{DD}, ADRV_{DD}, DALV_{DD} and DARV_{DD}) are connected together through the IC substrate with a few Ohms resistance, they should have identical voltages, and care should be exercised in handling the digital system power supply.

3. A/D Block DC Offset Adjustment

A DC offset component appears in the A/D block digital output due to manufacturing variations in the IC itself and in resistor values. When there is a DC offset, differences in the full scale level of the analog input are created. It is therefore necessary to adjust the DC offset adjustment point in the application circuit example (see the section "LC8390M Application Circuit Example") while monitoring the digital output, and to cut the DC component by performing HPF processing in the input processing block of the later stage DSP.

LC8390M Application Circuit Example

Unit (Resistance : Ω, Capacitance : F)

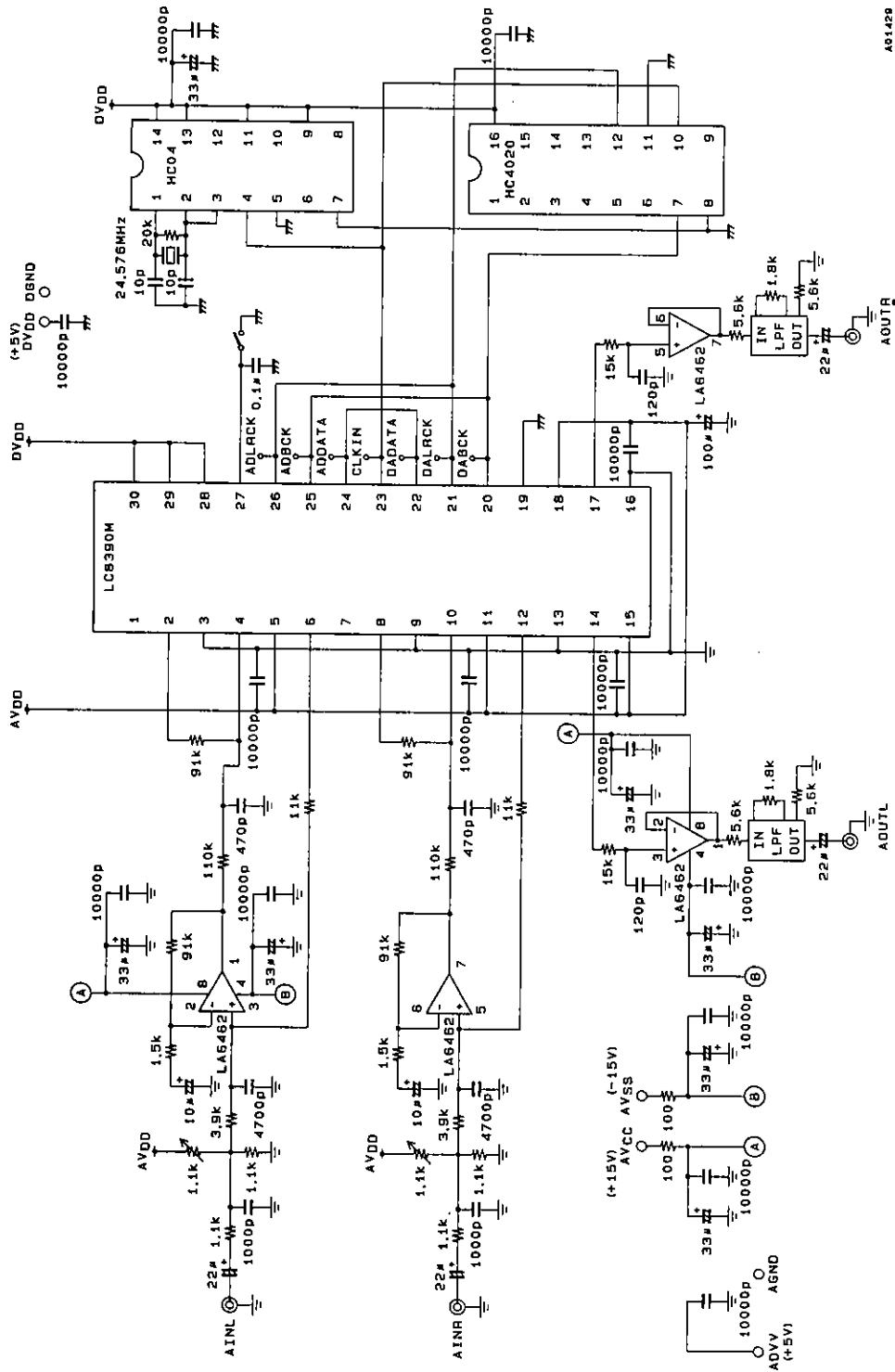

AD1428