

- Arc barrier equipped
- High dielectric strength (2,000 VAC)
- Long dependable service life assured by AgCdO contacts
- Choose models with single or bifurcated contacts, LED indicator, diode surge suppression, push-to-test button, or RC circuit
- All models meet UL and CSA approvals; VDE, LR, and SEV approved versions are available

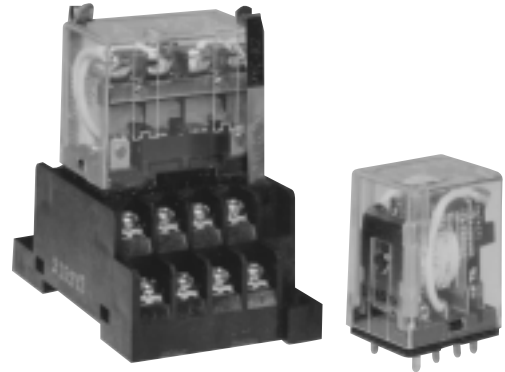

Ordering Information

To Order: Select the part number and add the desired coil voltage rating (e.g., LY1-DC6).

| Type | Terminal | Contact form | Part number | | | | | |
|---|----------------|--------------|---------------------------|------------------------|------------------------|---------------------------|------------------------|------------------------|
| | | | Single contact | | | Bifurcated contact | | |
| | | | Standard bracket mounting | Upper mounting bracket | Lower mounting bracket | Standard bracket mounting | Upper mounting bracket | Lower mounting bracket |
| Standard | Plug-in/solder | SPDT | LY1 | LY1F | LY1S | — | — | — |
| | | DPDT | LY2 | LY2F | LY2S | LY2Z | LY2ZF | LY2ZS |
| | | 3PDT | LY3 | LY3F | LY3S | — | — | — |
| | | 4PDT | LY4 | LY4F | LY4S | — | — | — |
| | PCB | SPDT | LY1-0 | — | — | — | — | — |
| | | DPDT | LY2-0 | — | — | LY2Z-0 | — | — |
| | | 3PDT | LY3-0 | — | — | — | — | — |
| | | 4PDT | LY4-0 | — | — | — | — | — |
| LED indicator | Plug-in/solder | SPDT | LY1N | — | — | — | — | — |
| | | DPDT | LY2N | — | — | LY2ZN | — | — |
| | | 3PDT | LY3N | — | — | — | — | — |
| | | 4PDT | LY4N | — | — | — | — | — |
| Diode surge suppression | Plug-in/solder | SPDT | LY1-D | — | — | — | — | — |
| | | DPDT | LY2-D | — | — | LY2Z-D | — | — |
| | | 3PDT | LY3-D | — | — | — | — | — |
| | | 4PDT | LY4-D | — | — | — | — | — |
| LED indicator and diode surge suppression | Plug-in/solder | SPDT | LY1N-D2 | — | — | — | — | — |
| | | DPDT | LY2N-D2 | — | — | LY2ZN-D2 | — | — |
| | | 4PDT | LY4N-D2 | — | — | — | — | — |
| RC circuit | Plug-in/solder | SPDT | LY1-CR | — | — | — | — | — |
| | | DPDT | LY2-CR | — | — | LY2Z-CR | — | — |
| LED indicator and RC circuit | Plug-in/solder | SPDT | LY1N-CR | — | — | — | — | — |
| | | DPDT | LY2N-CR | — | — | LY2ZN-CR | — | — |

Note: 1. Types with specifications other than those listed are available. Contact your OMRON Sales representative.
 2. To order connecting sockets and mounting tracks, see "Accessories" section.

Ordering Information, continued

| Type | Terminal | Contact form | Part number | | | | | |
|---------------------------------------|----------------|--------------|---------------------------|------------------------|------------------------|---------------------------|------------------------|------------------------|
| | | | Single contact | | | Bifurcated contact | | |
| | | | Standard bracket mounting | Upper mounting bracket | Lower mounting bracket | Standard bracket mounting | Upper mounting bracket | Lower mounting bracket |
| Push-to-test button | Plug-in/solder | SPDT | LY114 | — | — | — | — | — |
| | | DPDT | LY214 | — | — | LY2212 | — | — |
| | | 3PDT | LY314 | — | — | — | — | — |
| | | 4PDT | LY414 | — | — | — | — | — |
| LED indicator and push-to-test button | Plug-in/solder | DPDT | LY214N | — | — | LY2212N | — | — |
| | | 4PDT | LY414N | — | — | — | — | — |

Note: 1. Types with specifications other than those listed are available. Contact your OMRON Sales representative.
 2. To order connecting sockets and mounting tracks, see "Accessories" section.

■ ACCESSORIES

Connecting Sockets

To Order: Select the appropriate part numbers for sockets, clips, and mounting tracks (if required) from the following charts.

Track mounted sockets

| Relay | Socket* | Relay hold-down clip | | Mounting track |
|--------------|-----------------|----------------------|---------------|--|
| | | Standard | RC circuit | |
| SPDT DPDT | PTF08A-E | PYC-A1 | Y92H-3 | PFM-100N/PFM-50N & PFM-M or PFM-100N2 PFM-S (Option spacer) |
| 3PDT | PTF11A | | | |
| 4PDT | PTF14A-E | | | |

* Track mounted socket can be used as a front connecting socket.

Back connecting sockets

| Relay | Solder terminal socket | Wire wrap terminal socket | Relay hold-down clip | | | | Socket Mounting Plate | | | |
|--------------|------------------------|---------------------------|----------------------|---------------|--------------|--------------|-----------------------|---------------|---------------|---------------|
| | | | Standard | Push-to-test | RC circuit | Mtg. plate | 1 | 10 | 12 | 18 |
| SPDT DPDT | PT08 | PT08QN | PYC-P | PYC-P2 | PYC-1 | PYC-S | PYP-1 | — | — | PYP-18 |
| 3PDT | PT11 | PT11QN | | | | | PTP-1-3 | — | PTP-12 | — |
| 4PDT | PT14 | PT14QN | | | | | PTP-1 | PTP-10 | — | — |

Note: Types PYP-18, PTP-12 and PTP-10 may be cut to any desired length.

| Relay | PC terminal socket | Relay hold-down clip | | |
|--------------|--------------------|----------------------|---------------|--------------|
| | | Standard | Push-to-test | RC circuit |
| SPDT DPDT | PT08-0 | PYC-P | PYC-P2 | PYC-1 |
| 3PDT | PT11-0 | | | |
| 4PDT | PT14-0 | | | |

Specifications

■ CONTACT DATA

| Load | Single contact | | | | Bifurcated contact | |
|-------------------------|-----------------------------------|--|-----------------------------------|--|---------------------------------|--|
| | SPDT | | DPDT, 3PDT, 4PDT | | DPDT | |
| | Resistive load (p.f. = 1) | Inductive load (p.f. = 0.4) (L/R = 7 ms) | Resistive load (p.f. = 1) | Inductive load (p.f. = 0.4) (L/R = 7 ms) | Resistive load (p.f. = 1) | Inductive load (p.f. = 0.4) (L/R = 7 ms) |
| Rated load | 15 A at 110 VAC 15 A at 24 VDC | 10 A at 110 VAC 7 A at 24 VDC | 10 A at 110 VAC 10 A at 24 VDC | 7.5 A at 110 VAC 5 A at 24 VDC | 5 A at 110 VAC 5 A at 24 VDC | 4 A at 110 VAC 4 A at 24 VDC |
| Contact material | AgCdO | | | | | |
| Carry current | 15 A | | 10 A | | 7 A | |
| Max. operating voltage | 250 VAC 125 VDC | | | | | |
| Max. operating current | 15 A | | 10 A | | 7 A | |
| Max. switching capacity | 1,700 VA 360 W | 1,100 VA 170 W | 1,100 VA 240 W | 830 VA 120 W | 550 VA 120 W | 440 VA 100 W |
| Min. permissible load | 100 mA, 5 VDC | | | | 10 mA, 5 VDC | |

■ COIL DATA

1- and 2-pole types – AC

| Rated voltage (V) | Rated current (mA) | | Coil resistance (Ω) | Coil inductance (ref. value) (H) | | Pick-up voltage (% of rated voltage) | Dropout voltage | Maximum voltage | Power consumption (VA, W) |
|-------------------|--------------------|-----------|---------------------|----------------------------------|-------------|--------------------------------------|-----------------|-----------------|------------------------------|
| | 50 Hz | 60 Hz | | Armature OFF | Armature ON | | | | |
| 6 | 214.10 | 183 | 12.20 | 0.04 | 0.08 | 80% max. | 30% min. | 110% | Approx. 1.00 to 1.20 (60 Hz) |
| 12 | 106.50 | 91 | 46 | 0.17 | 0.33 | | | | |
| 24 | 53.80 | 46 | 180 | 0.69 | 1.30 | | | | |
| 50 | 25.70 | 22 | 788 | 3.22 | 5.66 | | | | |
| 100/110 | 11.70/12.90 | 10/11 | 3,750 | 14.54 | 24.60 | | | | Approx. 0.90 to 1.10 (60 Hz) |
| 110/120 | 9.90/10.80 | 8.40/9.20 | 4,430 | 19.20 | 32.10 | | | | |
| 200/220 | 6.20/6.80 | 5.30/5.80 | 12,950 | 54.75 | 94.07 | | | | |
| 220/240 | 4.80/5.30 | 4.20/4.60 | 18,790 | 83.50 | 136.40 | | | | |

1- and 2-pole types – DC

| Rated voltage (V) | Rated current (mA) | Coil resistance (Ω) | Coil inductance (ref. value) (H) | | Pick-up voltage (% of rated voltage) | Dropout voltage | Maximum voltage | Power consumption (VA, W) |
|-------------------|--------------------|---------------------|----------------------------------|-------------|--------------------------------------|-----------------|-----------------|---------------------------|
| | | | Armature OFF | Armature ON | | | | |
| 6 | 150 | 40 | 0.16 | 0.33 | 80% max. | 10% min. | 110% | Approx. 0.90 |
| 12 | 75 | 160 | 0.73 | 1.37 | | | | |
| 24 | 36.90 | 650 | 3.20 | 5.72 | | | | |
| 48 | 18.50 | 2,600 | 10.60 | 21 | | | | |
| 100/110 | 9.10/10 | 11,000 | 45.60 | 86.20 | | | | |

- Note: 1. The rated current and coil resistance are measured at a coil temperature of 23°C (73°F) with tolerances of +15%, -20% for AC rated current, and ±15% for DC rated coil resistance.
 2. The AC coil resistance and inductance are reference values at 60 Hz.
 3. The performance characteristics are measured at a coil temperature of 23°C (73°F).
 4. Class B coil insulation is available.

■ COIL DATA(continued)

3-pole type – AC

| Rated voltage (V) | Rated current (mA) | | Coil resistance (Ω) | Coil inductance (ref. value) (H) | | Pick-up voltage (% of rated voltage) | Dropout voltage | Maximum voltage | Power consumption (VA, W) |
|-------------------|--------------------|-------------|---------------------|----------------------------------|-------------|--------------------------------------|-----------------|-----------------|------------------------------|
| | 50 Hz | 60 Hz | | Armature OFF | Armature ON | | | | |
| 6 | 310 | 270 | 6.70 | 0.03 | 0.05 | 80% max. | 30% min. | 110% | Approx. 1.60 to 2.00 (60 Hz) |
| 12 | 159 | 134 | 24 | 0.12 | 0.21 | | | | |
| 24 | 80 | 67 | 100 | 0.44 | 0.79 | | | | |
| 50 | 38 | 33 | 410 | 2.24 | 3.87 | | | | |
| 100/110 | 15.90/18.30 | 13.60/15.60 | 2,300 | 10.50 | 18.50 | | | | |
| 120 | 17.30 | 14.8 | 2,450 | 11.50 | 20.60 | | | | |
| 200/220 | 10.50/11.60 | 9.00/9.90 | 8,650 | 34.80 | 59.50 | | | | |
| 240 | 9.40 | 8 | 10,400 | 38.60 | 74.60 | | | | |

3-pole type – DC

| Rated voltage (V) | Rated current (mA) | Coil resistance (Ω) | Coil inductance (ref. value) (H) | | Pick-up voltage (% of rated voltage) | Dropout voltage | Maximum voltage | Power consumption (VA, W) |
|-------------------|--------------------|---------------------|----------------------------------|-------------|--------------------------------------|-----------------|-----------------|---------------------------|
| | | | Armature OFF | Armature ON | | | | |
| 6 | 234 | 25.70 | 0.11 | 0.21 | 80% max. | 10% min. | 110% | Approx. 1.40 |
| 12 | 112 | 107 | 0.45 | 0.98 | | | | |
| 24 | 58.60 | 410 | 1.89 | 3.87 | | | | |
| 48 | 28.20 | 1,700 | 8.53 | 13.90 | | | | |
| 100/110 | 12.70/13 | 8,500 | 29.60 | 54.30 | | | | |

4-pole type – AC

| Rated voltage (V) | Rated current (mA) | | Coil resistance (Ω) | Coil inductance (ref. value) (H) | | Pick-up voltage (% of rated voltage) | Dropout voltage | Maximum voltage | Power consumption (VA, W) |
|-------------------|--------------------|------------|---------------------|----------------------------------|-------------|--------------------------------------|-----------------|-----------------|------------------------------|
| | 50 Hz | 60 Hz | | Armature OFF | Armature ON | | | | |
| 6 | 386 | 330 | 5 | 0.02 | 0.04 | 80% max. | 30% min. | 110% | Approx. 1.95 to 2.50 (60 Hz) |
| 12 | 199 | 170 | 20 | 0.10 | 0.17 | | | | |
| 24 | 93.60 | 80 | 78 | 0.38 | 0.67 | | | | |
| 50 | 46.80 | 40 | 350 | 1.74 | 2.88 | | | | |
| 100/110 | 22.50/25.50 | 19/21.80 | 1,800 | 10.50 | 17.30 | | | | |
| 120 | 19.00 | 16.40 | 2,200 | 9.30 | 19 | | | | |
| 200/220 | 11.50/13.10 | 9.80/11.20 | 6,700 | 33.10 | 57.90 | | | | |
| 240 | 11.00 | 9.50 | 9,000 | 33.20 | 63.40 | | | | |

4-pole type – DC

| Rated voltage (V) | Rated current (mA) | Coil resistance (Ω) | Coil inductance (ref. value) (H) | | Pick-up voltage (% of rated voltage) | Dropout voltage | Maximum voltage | Power consumption (VA, W) |
|-------------------|--------------------|---------------------|----------------------------------|-------------|--------------------------------------|-----------------|-----------------|---------------------------|
| | | | Armature OFF | Armature ON | | | | |
| 6 | 240 | 25 | 0.09 | 0.21 | 80% max. | 10% min. | 110% | Approx. 1.50 |
| 12 | 120 | 100 | 0.39 | 0.84 | | | | |
| 24 | 69 | 350 | 1.41 | 2.91 | | | | |
| 48 | 30 | 1,600 | 6.39 | 13.60 | | | | |
| 100/110 | 15/15.90 | 6,900 | 32 | 63.70 | | | | |

- Note: 1. The rated current and coil resistance are measured at a coil temperature of 23°C (73°F) with tolerances of +15%, -20% for AC rated current, and ±15% for DC rated coil resistance.
 2. The AC coil resistance and inductance are reference values at 60 Hz.
 3. The performance characteristics are measured at a coil temperature of 23°C (73°F).
 4. Class B coil insulation is available.

■ CHARACTERISTICS

| | | |
|-----------------------|--|---|
| Contact resistance | 50 mΩ max. | |
| Operate time | 25 ms max. | |
| Release time | 25 ms max. | |
| Operating frequency | Mechanically | 18,000 operations/hour |
| | Under rated load | 1,800 operations/hour |
| Insulation resistance | 100 MΩ min. (at 500 VDC) | |
| Dielectric strength | 2,000 VAC, 50/60 Hz for 1 minute 1,000 VAC, 50/60 Hz for 1 minute between contacts of same polarity | |
| Vibration | Mechanical durability | 10 to 55 Hz, 1.00 mm (0.04 in) double amplitude |
| | Malfunction durability | 10 to 55 Hz, 1.00 mm (0.04 in) double amplitude |
| Shock | Mechanical durability | 1,000 m/s ² (approx. 100 G) |
| | Malfunction durability | 200 m/s ² (approx. 20 G) |
| Ambient temperature | Operating | -40° to 70°C (-40° to 158°F) |
| Humidity | 35 to 85% RH | |
| Service Life | Mechanically | AC: 50 million operations min. (at operating frequency of 18,000 operations/hour) DC: 100 million operations min. (at operating frequency of 18,000 operations/hour) |
| | Electrically | See "Characteristic Data" |
| Weight | SPDT, DPDT: Approx. 40 g (1.41 oz), 3PDT: Approx. 50 g (1.76 oz) 4PDT: Approx. 70 g (2.47 oz) | |

Note: Data shown are of initial value.

■ CHARACTERISTIC DATA

Maximum switching capacity

LY1

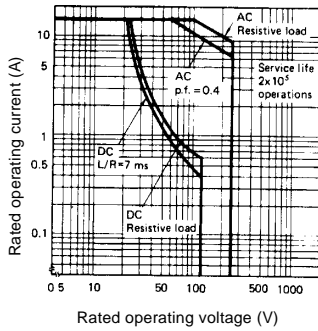

LY2

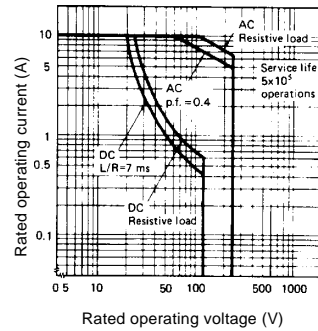

LY3, LY4

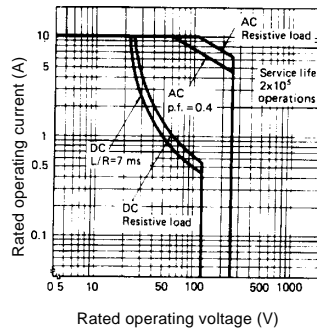

LY2Z

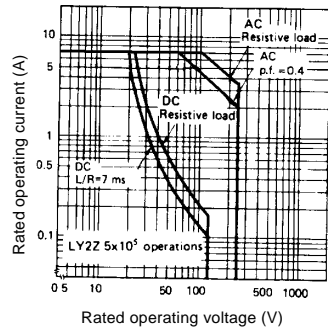

Electrical service life

LY1

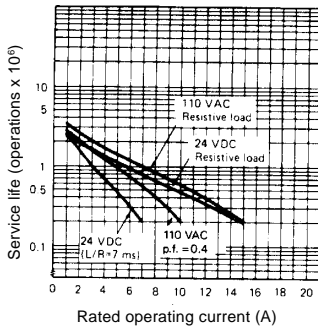

LY2

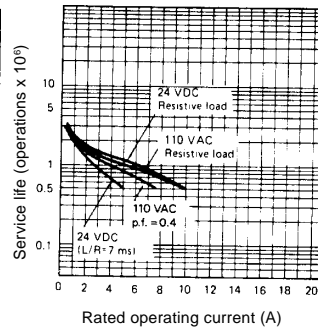

LY3, LY4

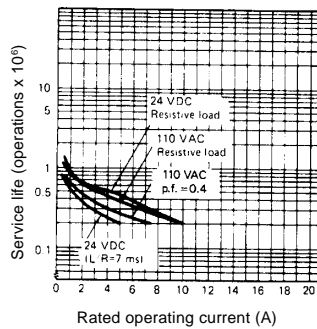

LY2Z

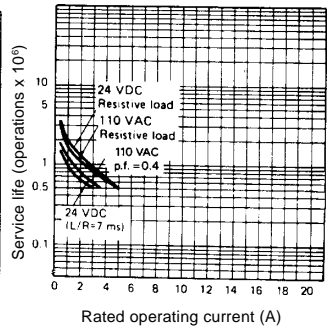

Dimensions

Unit: mm (inch)

RELAYS

LY1

Terminal arrangement (Bottom view)

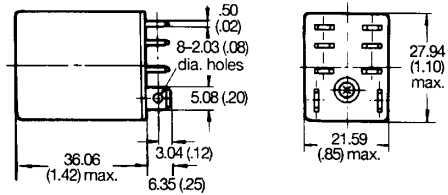

LY2

Terminal arrangement (Bottom view)

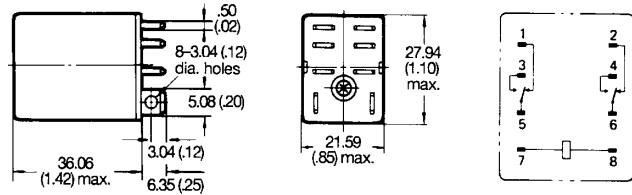

LY3

Terminal arrangement (Bottom view)

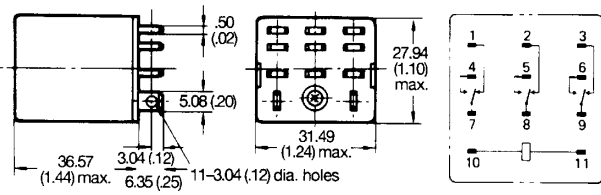

LY4

Terminal arrangement (Bottom view)

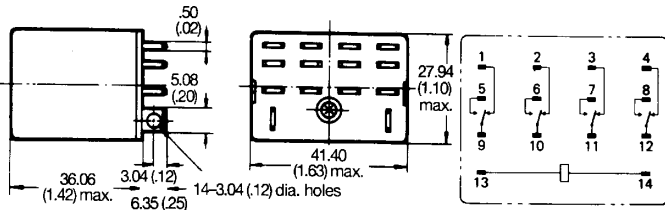

LY1-0, LY2-0, LY3-0, LY4-0

Mounting holes for LY1-0, LY2-0, LY3-0, LY4-0 (Bottom view)

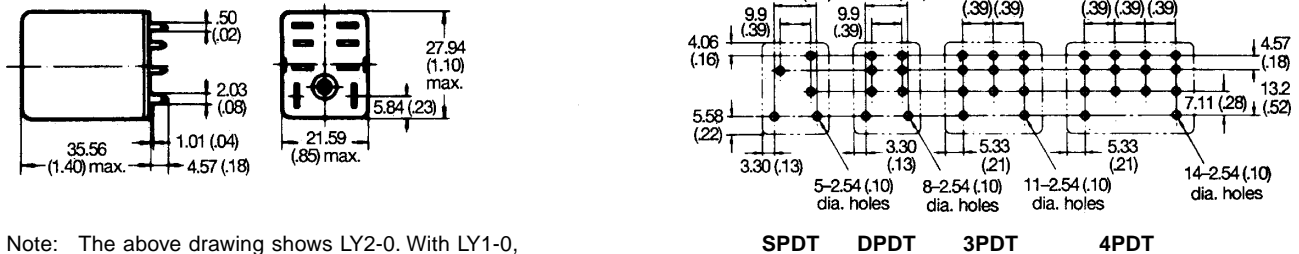

Note: The above drawing shows LY2-0. With LY1-0, dimension "*" should read as 6.35 (.25).

LY1F, LY2F

Mounting holes

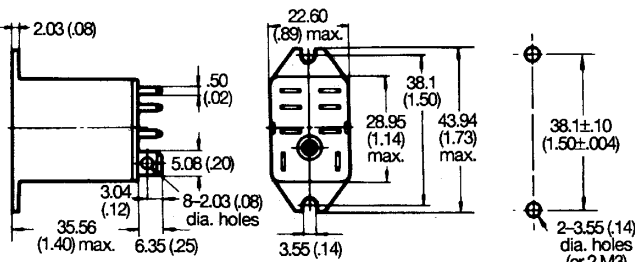

LY3F

Mounting holes

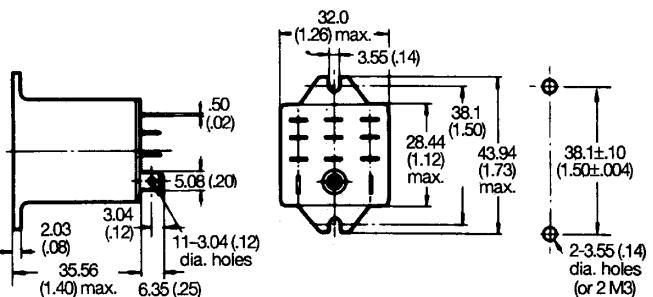

Note: The above drawing shows LY1F. With LY2F, dimension "*" should read as eight 3.05 mm (0.12 in) dia. holes.

LY4F

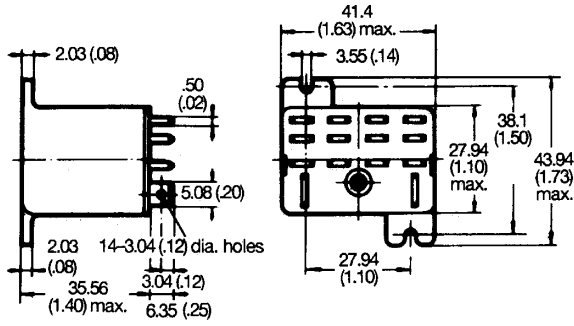

Mounting holes

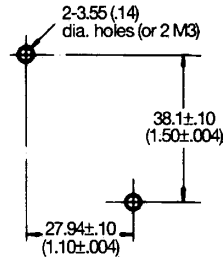

LY1S, LY2S

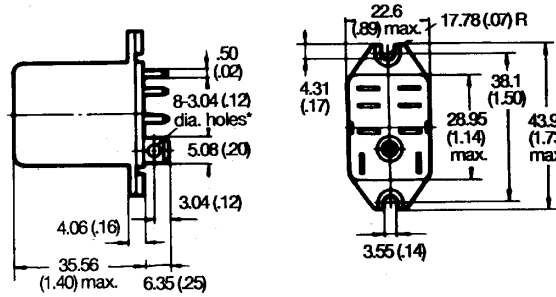

Round hole

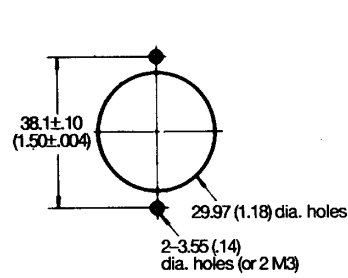

Rectangular hole

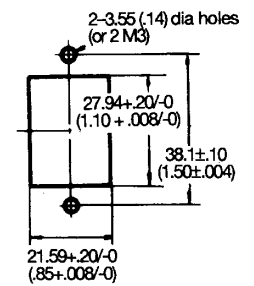

Note: The above drawing shows LY2S-US. With LY1S-US, dimension "*" should read as eight 2.03 mm (0.08 in) dia. holes.

LY3S

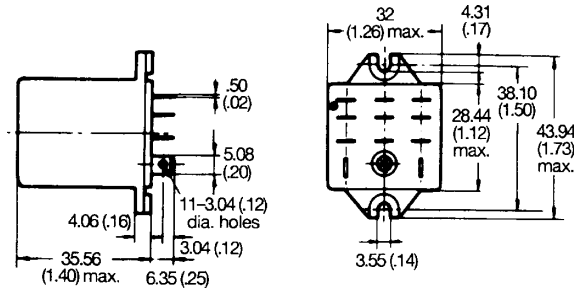

Round hole

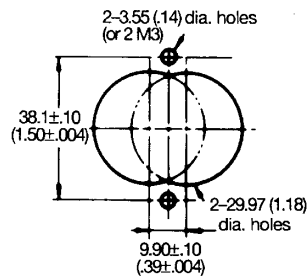

Rectangular hole

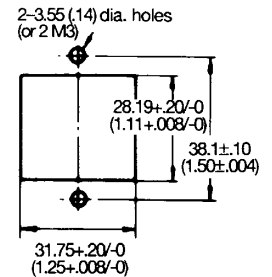

LY4S

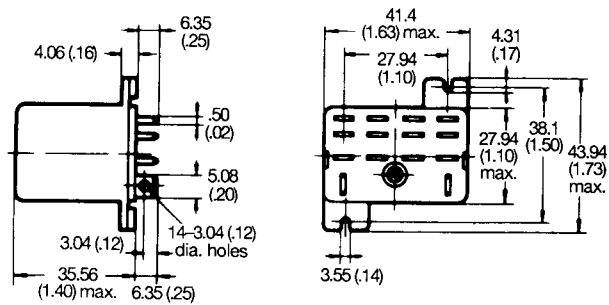

Round hole

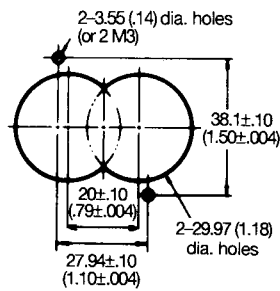

Rectangular hole

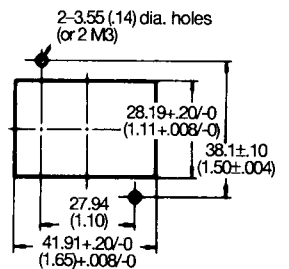

■ ACCESSORIES

Unit: mm (inch)

Track mounted sockets (UL File No. E87929) (CSA Report No. LR31928)

PTF08A-E

Terminal arrangement/
mounting holes
(Top view)

PTF11A

Terminal arrangement/
mounting holes
(Top view)

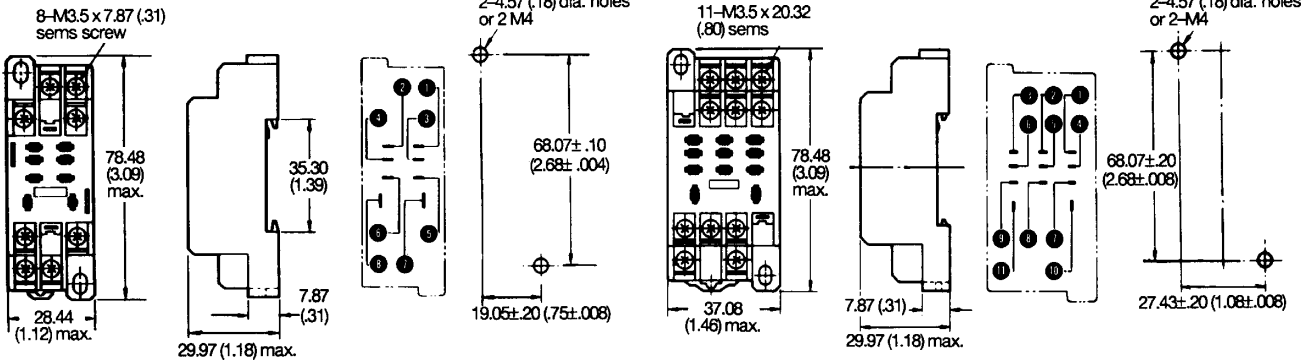

Track mounting sockets (UL File No. E87929) (CSA Report No. LR31928)

PTF14A-E

Terminal arrangement/
mounting holes
(Top view)

Mounting height of
relay with socket
(Applies to all PTF□A sockets)

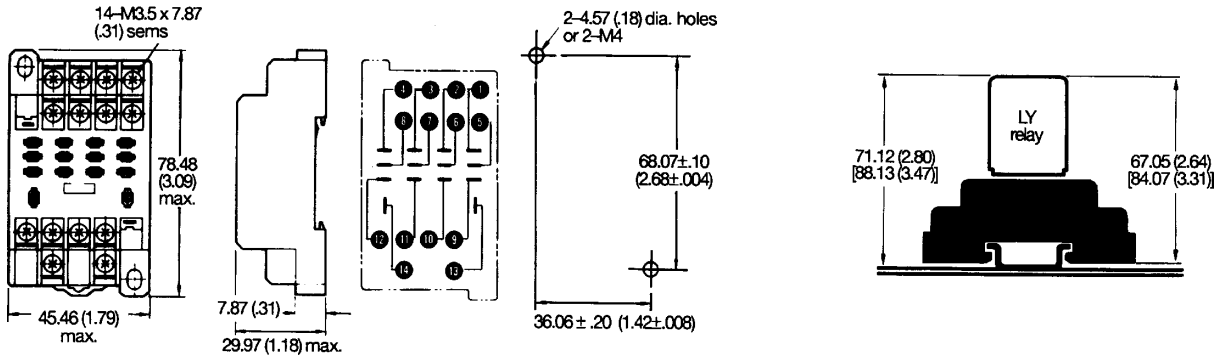

- Note: 1. UL/CSA does not apply to wire wrap (Q) type sockets.
- 2. Values in brackets for LY□CR.

Back connecting socket (UL File No. E87929) (CSA Report No. LR31928)

PT08

Terminal arrangement
(Bottom view)

PT11

Terminal arrangement
(Bottom view)

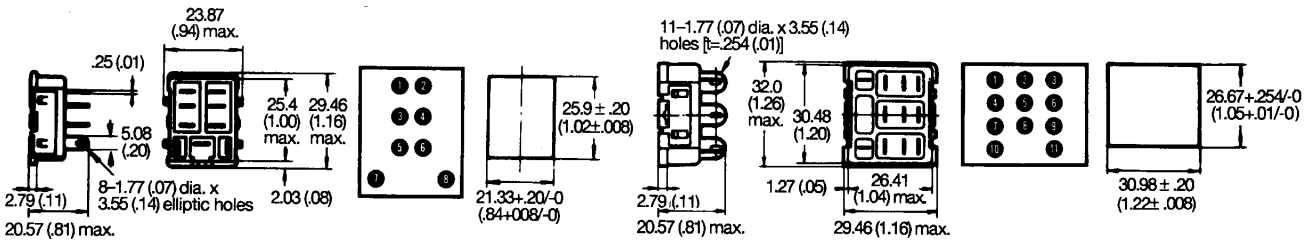

Back connecting socket (UL File No. E87929) (CSA Report No. LR31928)

PT14

Terminal arrangement
(Bottom view)

Mounting height of relay with socket
(Applies to all PT sockets)

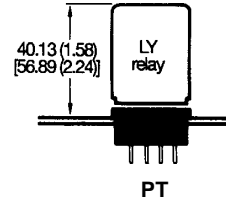
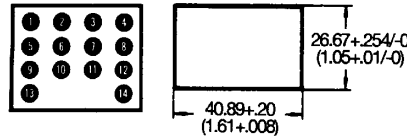
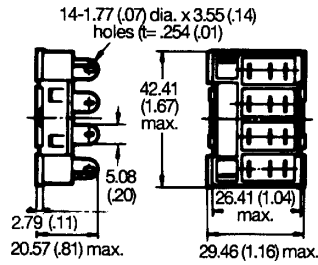

Note: Values in brackets for LY□CR.

Back connecting socket (UL File No. E87929) (CSA Report No. LR31928)

PT08QN

Panel cut-out and terminal arrangement are the same as Type PT08.

PT11QN

Panel cut-out and terminal arrangement are the same as Type PT11.

PT14QN

Panel cut-out and terminal arrangement are the same as Type PT14.

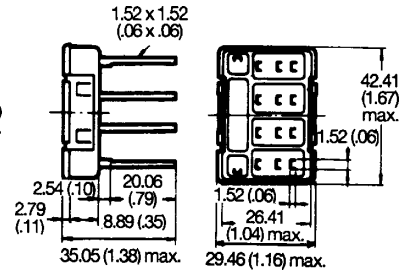
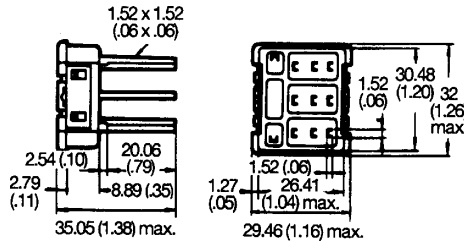
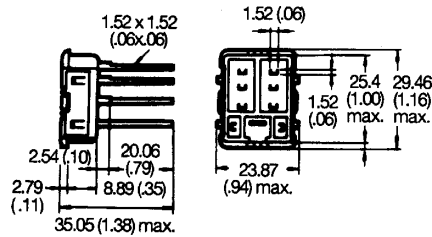

Back connecting socket (UL File No. E87929) (CSA Report No. LR31928)

PT08-0

Terminal arrangement is the same as Type PT08.

Mounting holes
(Bottom view)

PT11-0

Terminal arrangement is the same as Type PT11.

Mounting holes
(Bottom view)

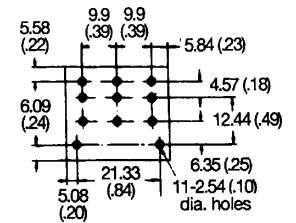
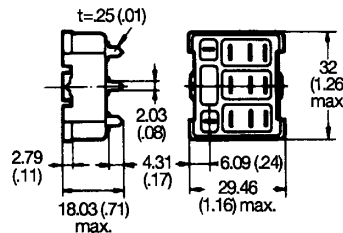
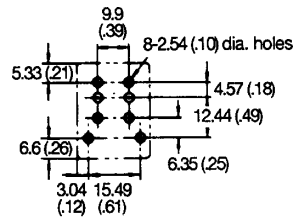
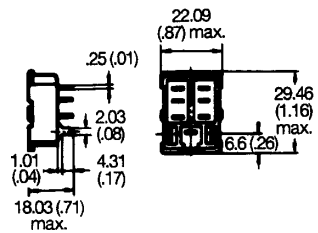

Back connecting socket (UL File No. E87929) (CSA Report No. LR31928)

PT14-0

Terminal arrangement is the same as Type PT14.

Mounting holes
(Bottom view)

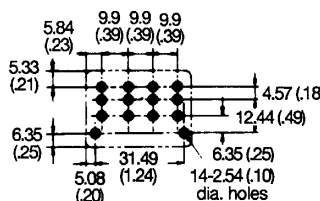
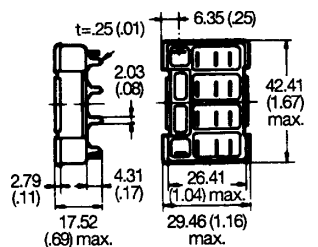

■ ACCESSORIES (continued)

Unit: mm (inch)

Relay hold-down clips

PYC-A1

For PTF□A socket

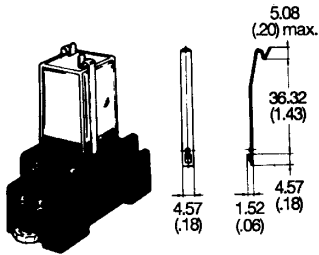

PYC-S

For relay mounting plates
(Applicable to Type PYP-1 and PYP-18 socket mounting plates only.)

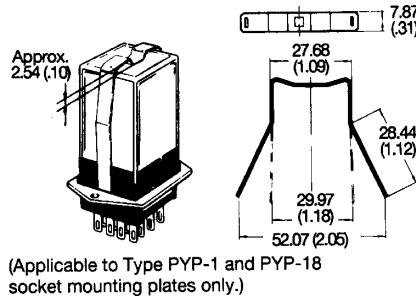

PYC-P

For PT□ socket

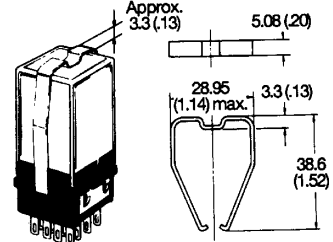

Relay hold-down clips

PYC-P2

For push-to-test button type with PT□ socket

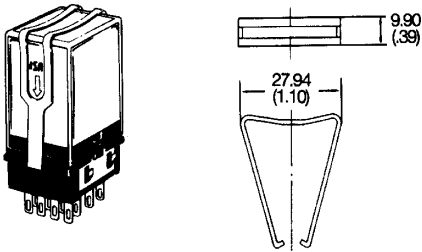

Y92H-3

For RC circuit type

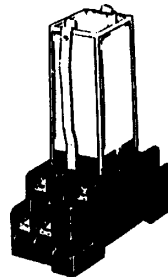

PYC-1

For RC circuit type



Mounting track/end plate/spacer

PFP-100N/PFP-50N mounting track

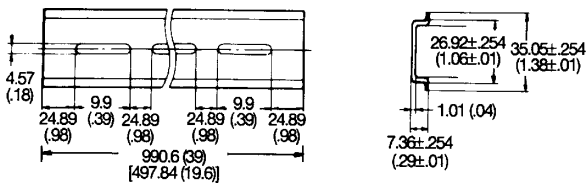

PFP-M end plate

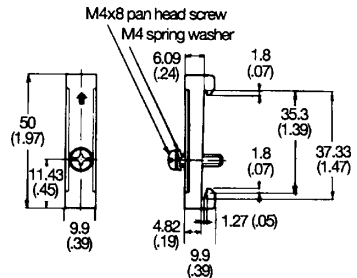

PFP-100N2 mounting track

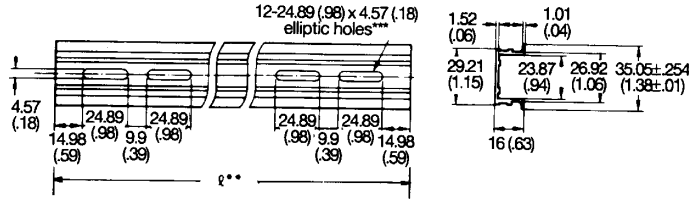

PFP-S spacer

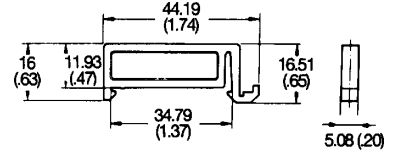

* This dimension is 14.99 mm (0.59 in) on both ends in the case of PFP-100N, but on one end in the case of PFP-50N.

- ** L = Length
 PFP-50N L = 497.84 mm (19.60 in)
 PFP-100N L = 990.60 mm (39.00 in)
 PFP-100N2 L = 990.60 mm (39.00 in)

*** A total of twelve 24.89 x 4.57 mm (0.98 x 0.18 in) elliptical holes are provided, with six holes cut from each end of the track at a pitch of 9.91 (0.39) between holes.

Socket mounting plates [t=1.52 (.06)]

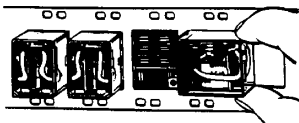

| | Number of socket specs. | | | |
|---------------|-------------------------|--------|---------|--------|
| Socket needed | 1 | 10 | 12 | 18 |
| PT08, PT08QN | PYP-1 | - | - | PYP-18 |
| PT11, PT11QN | PTP-1-3 | - | PTP-1-2 | - |
| PT14, PT14QN | PTP-1 | PTP-10 | - | - |

PYP-1

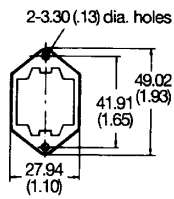

PTP-1-3

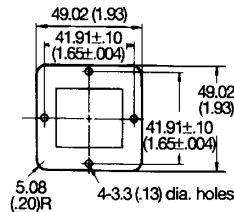

PTP-1

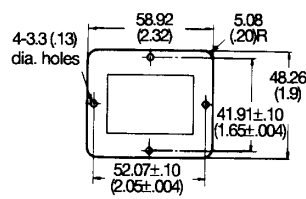

PYP-18

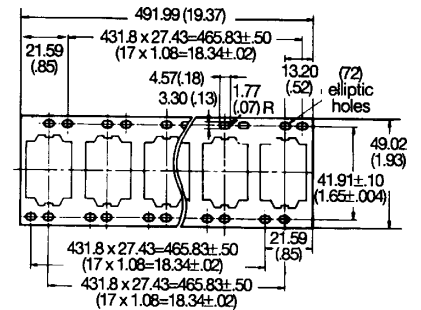

PTP-10

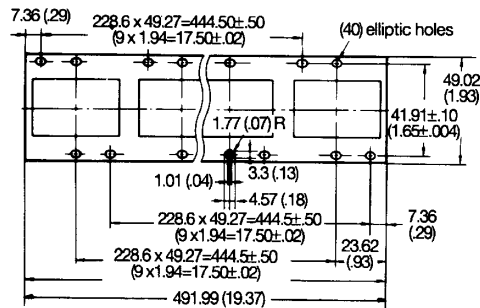

PTP-12

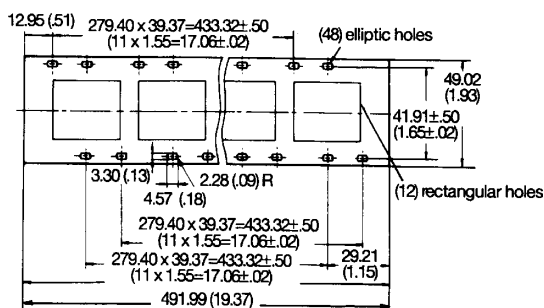

RELAY OPTIONS

LED Indicator

Specifications and dimensions same as the Standard Type with the following exception. With the LED indicator type, the rated current is approximately 0 to 5.0 mA higher than the Standard Type.

Terminal arrangement/Internal connections (Bottom view)

LY2N

DC coil rating type

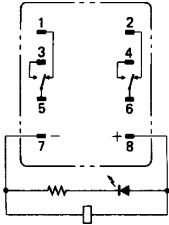

AC coil rating type

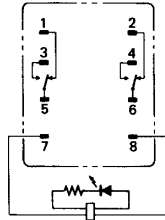

- Note:
1. The coil terminals 10 and 11 of Type LY3N become (-) and (+) and terminals 13 and 14 of Type LY4N become (-) and (+), respectively.
 2. Pay special attention to the polarities when using the DC type.

Diode Surge Suppression

Specifications and dimensions same as the Standard Type with the following exception. Ambient operating temperature: -25° to 40°C (-13° to 104°F)

Without Diode

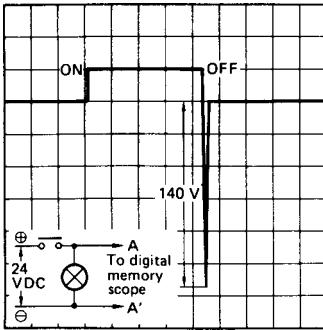

With Diode

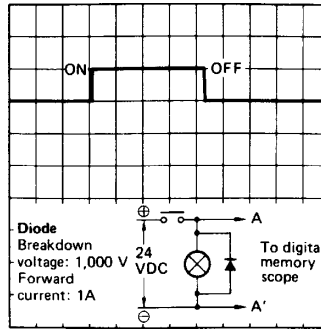

Terminal arrangement/Internal connections (Bottom view)

LY2(N)-D(2)

LY2-D

6, 12, 24, 48
100/110 VDC

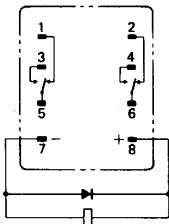

LY2N-D2

6, 12, 24, 48 VDC

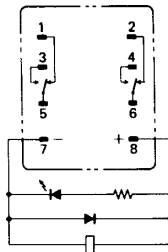

LY2N-D2

100/110 VDC

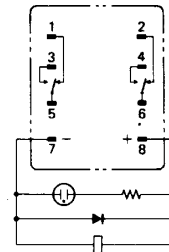

- Note:
1. Pay special attention to the polarities when using the DC type.
 2. The release time is somewhat longer, but satisfies the standard specifications of 25 ms.
 3. The reverse-breakdown voltage of the diode is 1,000 VDC.
 4. Available on DC versions only.

■ RELAY OPTIONS

RC Circuit

Specifications and dimensions same as the Standard Type with the following exceptions.

Characteristic Data

Without RC circuit

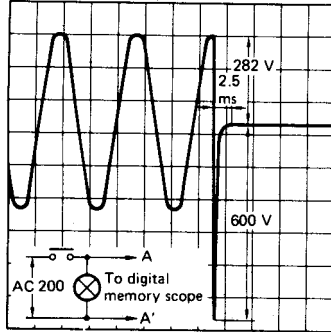

With RC circuit

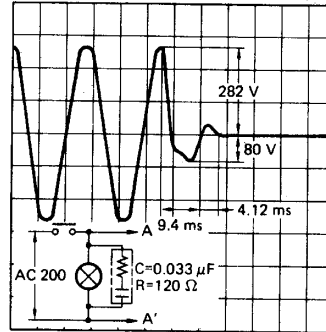

LY1-CR, LY2(Z)-CR

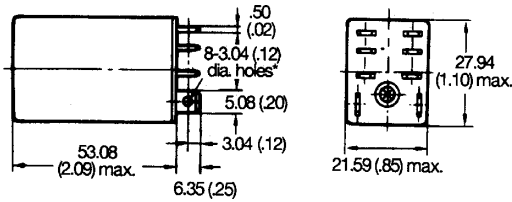

Terminal arrangement/Internal connections (Bottom view)

LY1-CR

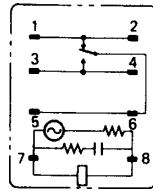

LY2(Z)-CR

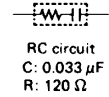
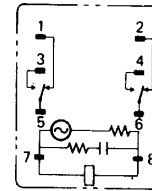

- Note: 1. The above drawing shows LY2(Z)-CR. With LY1-CR, "*" should read eight 2.03 mm (0.08 in) dia. holes.
2. Available on AC versions only.

Push-to-test Button

Specifications and dimensions same as the Standard Type with the following exceptions.

LY□12



LY112, LY212

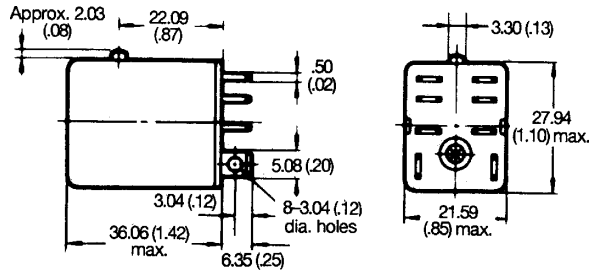

- Note: Type LY112 has the same dimensions and appearances as Type LY212 shown except that dimension "*" is 2.03 mm (0.08 in) dia. holes

LY312

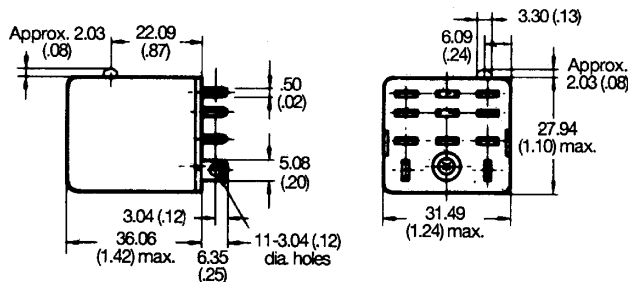

LY412

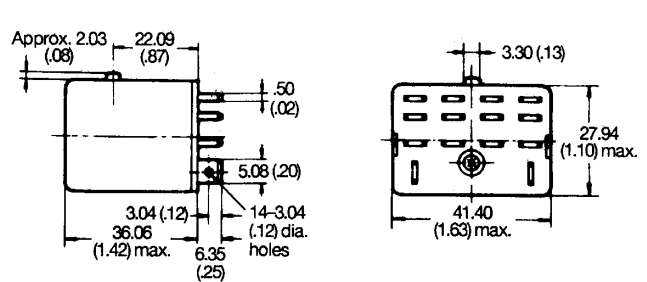

■ APPROVALS

UL recognized type (File No. E41643)

| Type | Contact form | Coil ratings | Contact ratings |
|------|--------------|------------------------------|---------------------------|
| LY□ | SPDT | 6 to 240 VAC 6 to 120 VDC | 15 A, 240 VAC (Inductive) |
| | | | 15 A, 28 VDC (Resistive) |
| | | | TV-5 (ACTV) |
| | | | 1/2 HP, 120 VAC (Motor) |
| LY□ | DPDT | | 13 A, 120 VAC (Resistive) |
| | | | 12 A, 240 VAC (Inductive) |
| | | | 10 A, 28 VDC (Resistive) |
| | | | TV-3 (ACTV) |
| LY□ | 3PDT 4PDT | | 1/2 HP, 120 VAC (Motor) |
| | | | 10 A, 240 VAC (Inductive) |
| | | | 10 A, 28 VDC (Resistive) |
| | | | 1/2 HP, 240 VAC (Motor) |

CSA certified type (File No. LR31928)

| Type | Contact form | Coil ratings | Contact ratings |
|------|--------------|------------------------------|---------------------------|
| LY□ | SPDT | 6 to 240 VAC 6 to 120 VDC | 15 A, 120 VAC (Inductive) |
| | | | 10 A, 240 VAC (Inductive) |
| | | | 15 A, 28 VDC (Resistive) |
| | | | TV-5 (ACTV) |
| LY□ | DPDT | | 13 A, 28 VDC (Resistive) |
| | | | 12 A, 120 VAC (Inductive) |
| | | | 10 A, 240 VAC (Inductive) |
| | | | 1/3 HP, 120 VAC (Motor) |
| LY□ | 3PDT 4PDT | | TV-3 (ACTV) |
| | | | 10 A, 240 VAC (Inductive) |
| | | | 10 A, 28 VDC (Resistive) |

VDE approved type (File No. 9903 [SPDT, DPDT & 3PDT], File No. 9947 [4PDT])

| Type | Contact form | Coil ratings | Contact ratings |
|--------|----------------------|---|---------------------------|
| LY□-VD | SPDT | 6, 12, 24, 50, 110, 220 VAC and 6, 12, 24, 48, 110 VDC | 10 A, 220 VAC (Resistive) |
| | | | 10 A, 28 VDC (Resistive) |
| | | | 7 A, 220 VAC (Inductive) |
| | | | 7 A, 28 VDC (Inductive) |
| LY□-VD | DPDT 3PDT 4PDT | | 7 A, 220 VAC (Resistive) |
| | | | 7 A, 28 VDC (Resistive) |
| | | | 4 A, 220 VAC (Inductive) |
| | | | 4 A, 28 VDC (Inductive) |

LR (Lloyd's Register) approved type (File No. 562KOB-204523)

| Type | Contact form | Coil ratings | Contact ratings |
|------|--------------|------------------------------|----------------------------|
| LY□ | DPDT 4PDT | 6 to 240 VAC 6 to 110 VDC | 7.5 A, 230 VAC (Inductive) |
| | | | 5 A, 24 VDC (Inductive) |

SEV listed type (File No. D7 91/82 [2- & 4-pole], D 91/204a [1- & 3-pole])

| Type | Contact form | Coil ratings | Contact ratings |
|--------|----------------------|------------------------------|---------------------------|
| LY□-SV | SPDT | 6 to 240 VAC 6 to 110 VDC | 15 A, 220 VAC (Resistive) |
| | | | 15 A, 24 VDC (Resistive) |
| LY□-SV | DPDT 3PDT 4PDT | | 10 A, 220 VAC (Resistive) |
| | | | 10 A, 24 VDC (Resistive) |

- Note: 1. The rated values approved by each of the safety standards (e.g., UL, CSA, VDE, and SEV) may be different from the performance characteristics individually defined in this catalog.
2. In the interest of product improvement, specifications are subject to change.

OMRON ELECTRONICS, INC.

One East Commerce Drive
Schaumburg, IL 60173
1-800-55-OMRON

Cat. No. GC RLY7

01/00

Specifications subject to change without notice.

OMRON CANADA, INC.

885 Milner Avenue
Scarborough, Ontario M1B 5V8
416-286-6465

Printed in the U.S.A.