

3.5A, 30V, Avalanche Rated, Logic Level, Dual N-Channel LittleFET™ Enhancement Mode Power MOSFET

January 1997

Features

- 3.5A, 30V
- $r_{DS(ON)} = 0.060\Omega$
- *Temperature Compensating PSPICE Model*
- *On-Resistance vs Gate Drive Voltage Curves*
- *Peak Current vs Pulse Width Curve*
- *UIS Rating Curve*

Ordering Information

PART NUMBER	PACKAGE	BRAND
RF1K49088	MS-012AA	RF1K49088

NOTE: When ordering, use the entire part number. For ordering in tape and reel, add the suffix 96 to the part number, i.e. RF1K4908896.

Description

The RF1K49088 Dual N-Channel power MOSFET is manufactured using an advanced MegaFET process. This process, which uses feature sizes approaching those of LSI integrated circuits, gives optimum utilization of silicon, resulting in outstanding performance. It is designed for use in applications such as switching regulators, switching converters, motor drivers, relay drivers, and low voltage bus switches. This product achieves full rated conduction at a gate bias in the 3V - 5V range, thereby facilitating true on-off power control directly from logic level (5V) integrated circuits.

Formerly developmental type TA49088.

Symbol

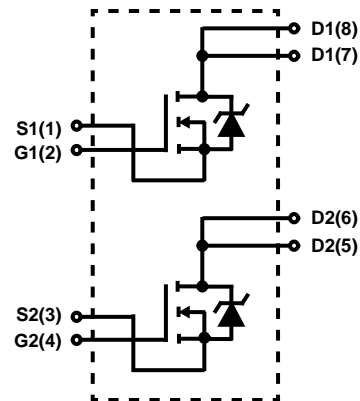

Packaging

JEDEC MS-012AA

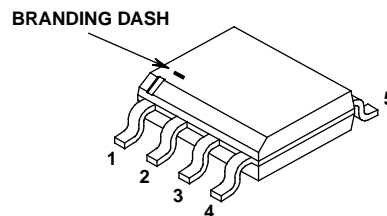

LittleFET™ is a trademark of Harris Corporation

RF1K49088

Absolute Maximum Ratings $T_A = 25^\circ\text{C}$ Unless Otherwise Specified

		RF1K49088	UNITS
Drain to Source Voltage	V_{DSS}	30	V
Drain to Gate Voltage	V_{DGR}	30	V
Gate to Source Voltage	V_{GS}	± 10	V
Drain Current			
Continuous (Pulse Width = 5s)	I_D	3.5	A
Pulsed	I_{DM}	Refer to Peak Current Curve	
Pulsed Avalanche Rating	E_{AS}	Refer to UIS Curve	
Power Dissipation			
$T_A = 25^\circ\text{C}$	P_D	2	W
Derate Above 25°C		0.016	W/ $^\circ\text{C}$
Operating and Storage Temperature	T_{STG}, T_J	-55 to 150	$^\circ\text{C}$
Soldering Temperature of Leads for 10s	T_L	260	$^\circ\text{C}$

CAUTION: Stresses above those listed in "Absolute Maximum Ratings" may cause permanent damage to the device. This is a stress only rating and operation of the device at these or any other conditions above those indicated in the operational sections of this specification is not implied.

Electrical Specifications $T_A = 25^\circ\text{C}$, Unless Otherwise Specified

PARAMETER	SYMBOL	TEST CONDITIONS	MIN	TYP	MAX	UNITS	
Drain to Source Breakdown Voltage	BV_{DSS}	$I_D = 250\mu\text{A}, V_{GS} = 0\text{V}$	30	-	-	V	
Gate Threshold Voltage	$V_{GS(TH)}$	$V_{GS} = V_{DS}, I_D = 250\mu\text{A}$	1	-	2	V	
Zero Gate Voltage Drain Current	I_{DSS}	$V_{DS} = 30\text{V}, V_{GS} = 0\text{V}$	$T_A = 25^\circ\text{C}$	-	-	1	μA
			$T_A = 150^\circ\text{C}$	-	-	50	μA
Gate to Source Leakage Current	I_{GSS}	$V_{GS} = \pm 10\text{V}$	-	-	100	nA	
On Resistance	$r_{DS(ON)}$	$I_D = 3.5\text{A}, V_{GS} = 5\text{V}$	-	-	0.060	Ω	
Turn-On Time	t_{ON}	$V_{DD} = 15\text{V}, I_D = 3.5\text{A}, R_L = 4.29\Omega, V_{GS} = 5\text{V}, R_{GS} = 25\Omega$	-	-	100	ns	
Turn-On Delay Time	$t_{d(ON)}$		-	18	-	ns	
Rise Time	t_r		-	60	-	ns	
Turn-Off Delay Time	$t_{d(OFF)}$		-	53	-	ns	
Fall Time	t_f		-	47	-	ns	
Turn-Off Time	t_{OFF}		-	-	125	ns	
Total Gate Charge	$Q_g(TOT)$		$V_{GS} = 0\text{V to } 10\text{V}$	$V_{DD} = 24\text{V}, I_D = 3.5\text{A}, R_L = 6.86\Omega$	-	24	30
Gate Charge at 5V	$Q_g(5)$	$V_{GS} = 0\text{V to } 5\text{V}$	-		13	17	nC
Threshold Gate Charge	$Q_g(TH)$	$V_{GS} = 0\text{V to } 1\text{V}$	-		0.8	1.0	nC
Input Capacitance	C_{ISS}	$V_{DS} = 25\text{V}, V_{GS} = 0\text{V}, f = 1\text{MHz}$	-	750	-	pF	
Output Capacitance	C_{OSS}		-	275	-	pF	
Reverse Transfer Capacitance	C_{RSS}		-	100	-	pF	
Thermal Resistance Junction-to-Ambient	$R_{\theta JA}$	Pulse width = 1s Device mounted on FR-4 material	-	-	62.5	$^\circ\text{C/W}$	

Source to Drain Diode Ratings and Specifications

PARAMETER	SYMBOL	TEST CONDITIONS	MIN	TYP	MAX	UNITS
Forward Voltage	V_{SD}	$I_{SD} = 3.5\text{A}$	-	-	1.25	V
Reverse Recovery Time	t_{rr}	$I_{SD} = 3.5\text{A}, dI_{SD}/dt = 100\text{A}/\mu\text{s}$	-	-	50	ns

Typical Performance Curves

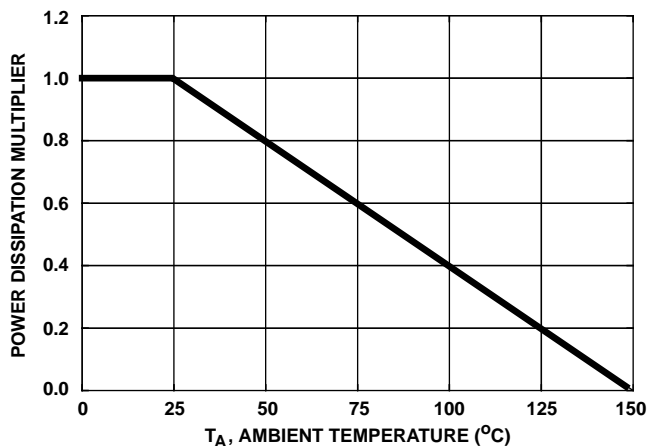

FIGURE 1. NORMALIZED POWER DISSIPATION vs TEMPERATURE DERATING CURVE

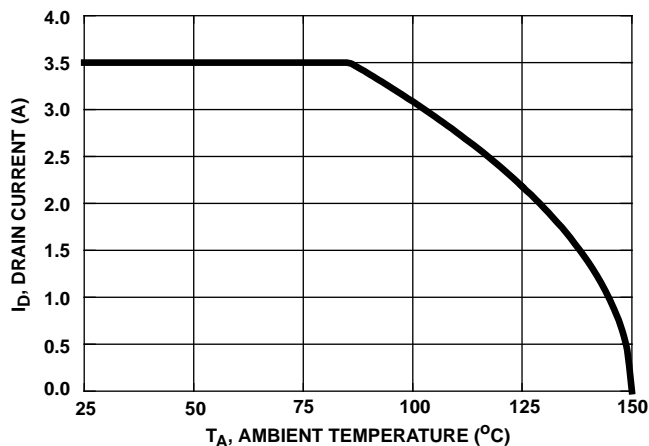

FIGURE 2. MAXIMUM CONTINUOUS DRAIN CURRENT vs TEMPERATURE

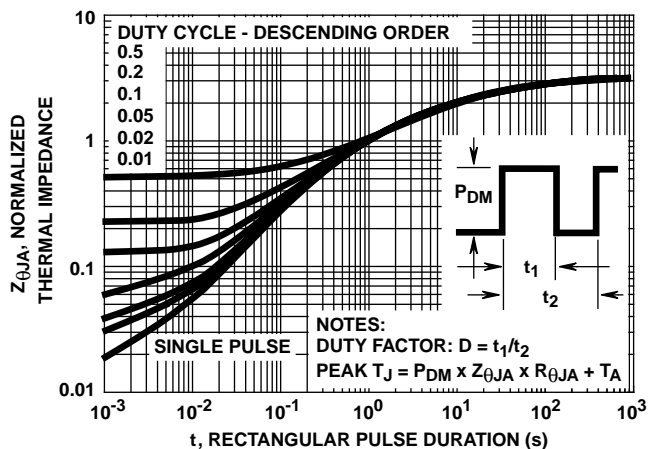

FIGURE 3. NORMALIZED MAXIMUM TRANSIENT THERMAL IMPEDANCE

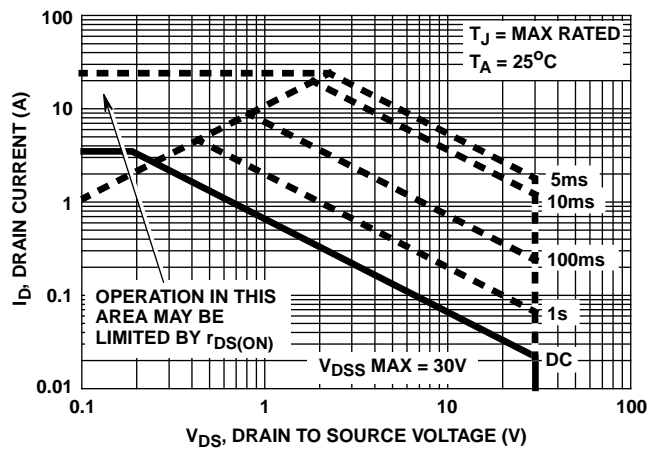

FIGURE 4. FORWARD BIAS SAFE OPERATING AREA

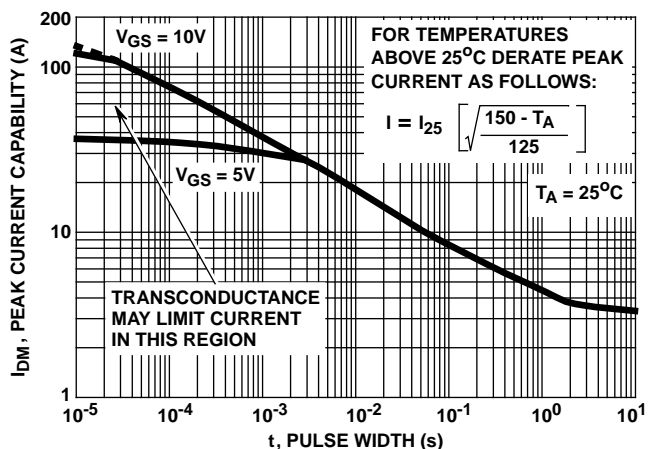
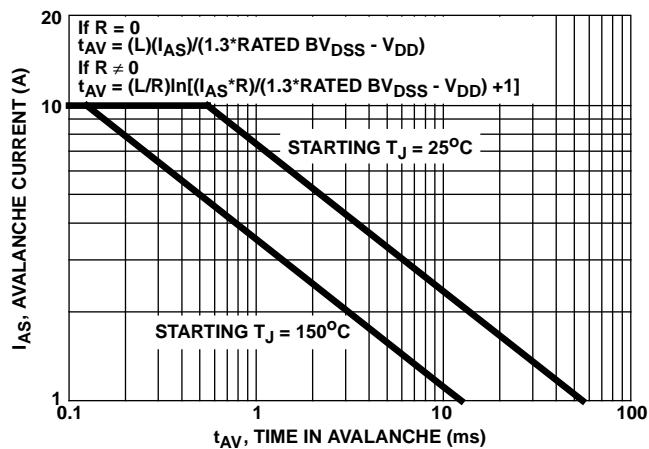

FIGURE 5. PEAK CURRENT CAPABILITY



NOTE: Refer to Harris Application Notes AN9321 and AN9322.

FIGURE 6. UNCLAMPED INDUCTIVE SWITCHING CAPABILITY

Typical Performance Curves (Continued)

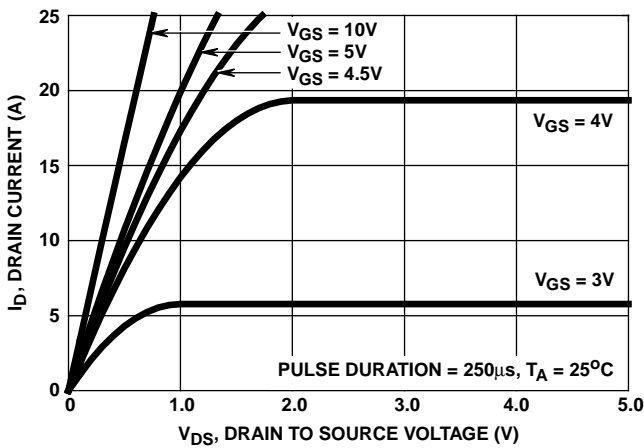

FIGURE 7. SATURATION CHARACTERISTICS

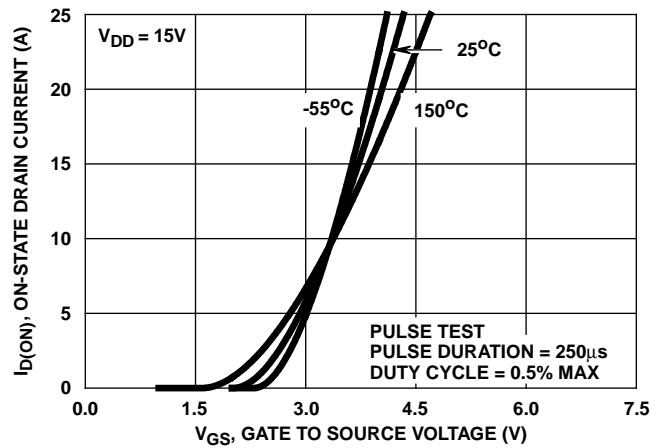

FIGURE 8. TRANSFER CHARACTERISTICS

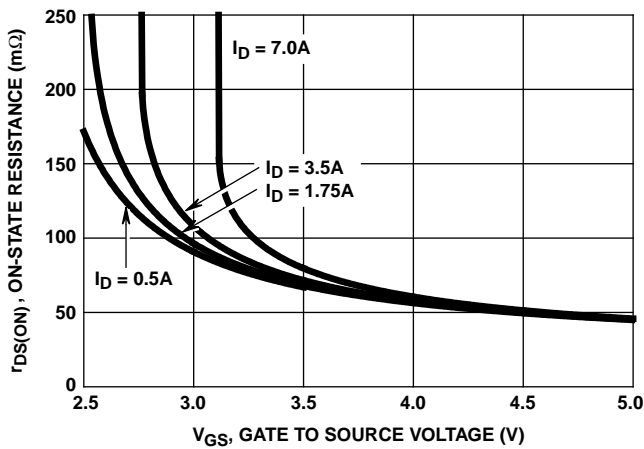

FIGURE 9. $r_{DS(ON)}$ FOR VARYING CONDITIONS OF GATE VOLTAGE AND DRAIN CURRENT

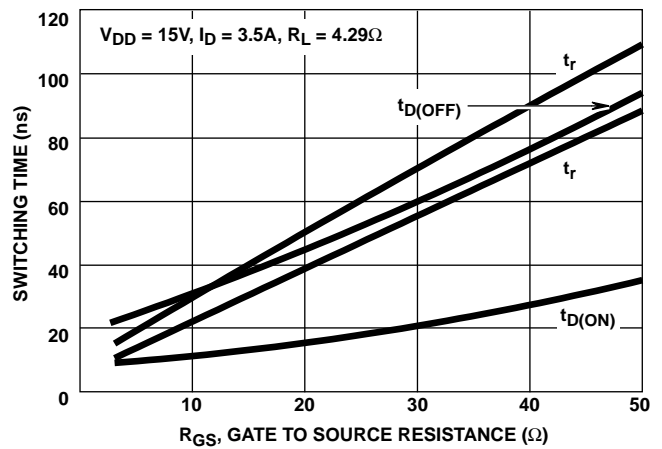

FIGURE 10. SWITCHING TIME AS A FUNCTION OF GATE RESISTANCE

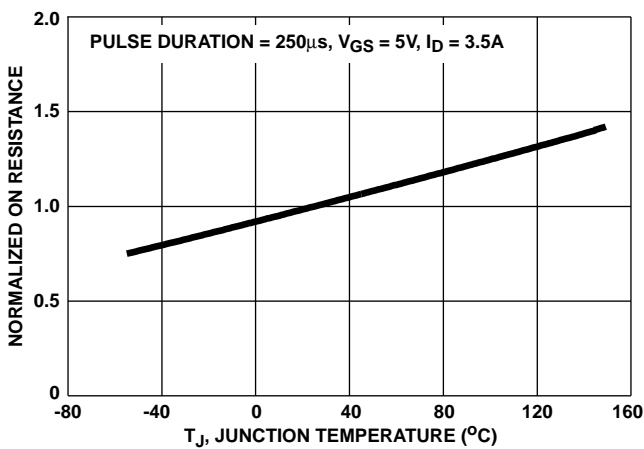

FIGURE 11. NORMALIZED $r_{DS(ON)}$ vs JUNCTION TEMPERATURE

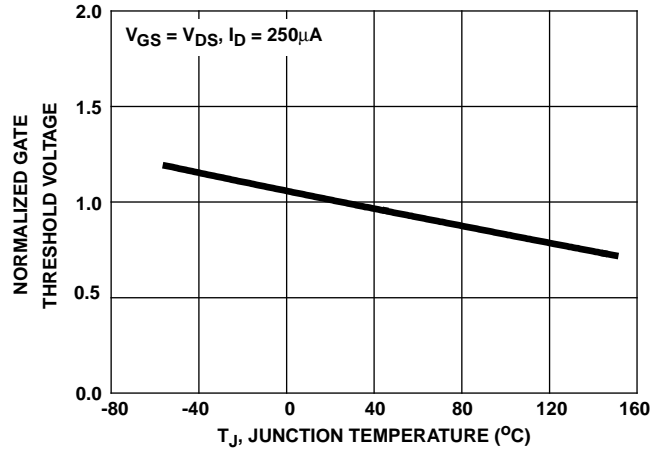

FIGURE 12. NORMALIZED GATE THRESHOLD VOLTAGE vs JUNCTION TEMPERATURE

Typical Performance Curves (Continued)

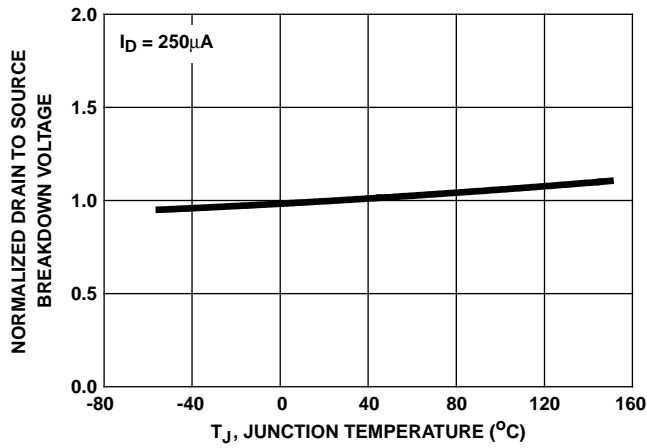

FIGURE 13. NORMALIZED DRAIN TO SOURCE BREAKDOWN VOLTAGE vs JUNCTION TEMPERATURE

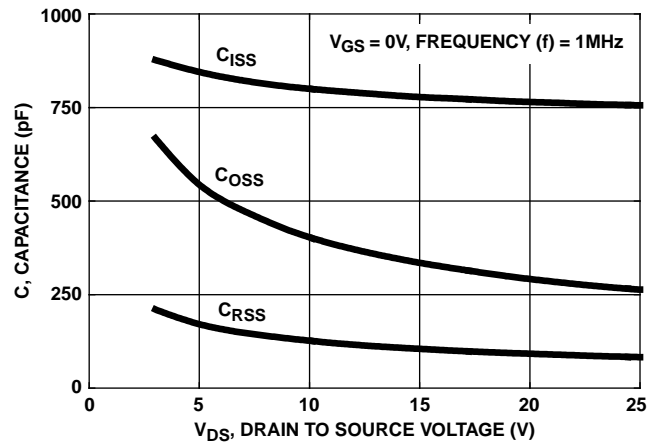
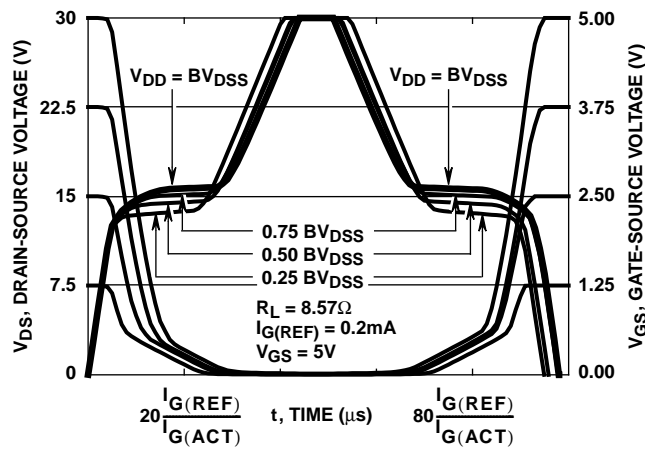

FIGURE 14. CAPACITANCE vs VOLTAGE



NOTE: Refer to Harris Application Notes AN7254 and AN7260.

FIGURE 15. NORMALIZED SWITCHING WAVEFORMS FOR CONSTANT GATE CURRENT

Test Circuits and Waveforms

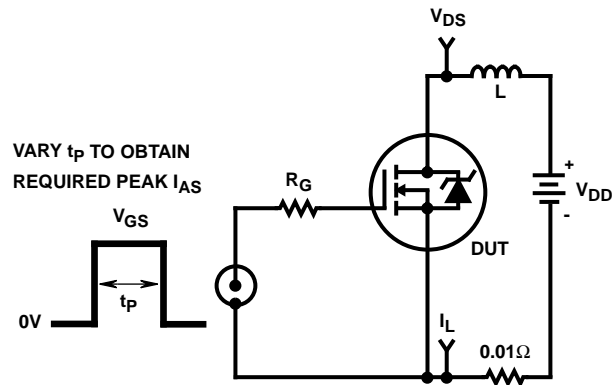

FIGURE 16. UNCLAMPED ENERGY TEST CIRCUIT

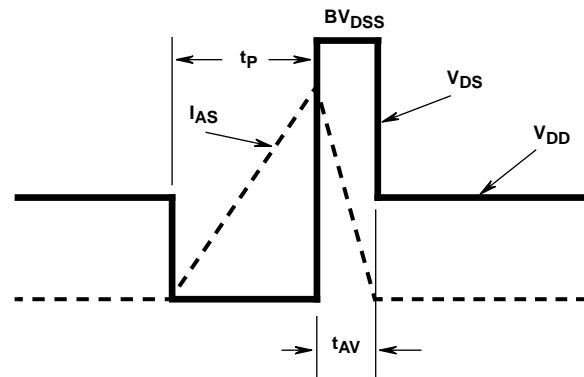

FIGURE 17. UNCLAMPED ENERGY WAVEFORMS

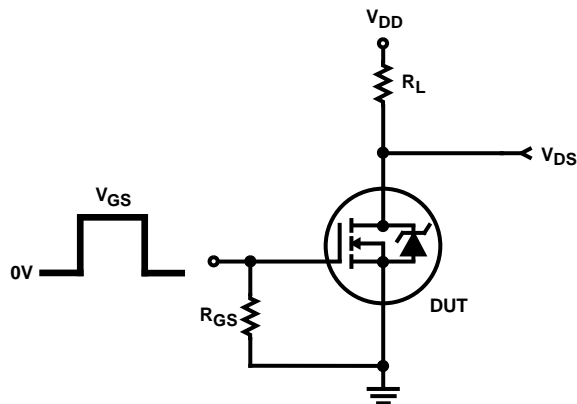

FIGURE 18. RESISTIVE SWITCHING TEST CIRCUIT

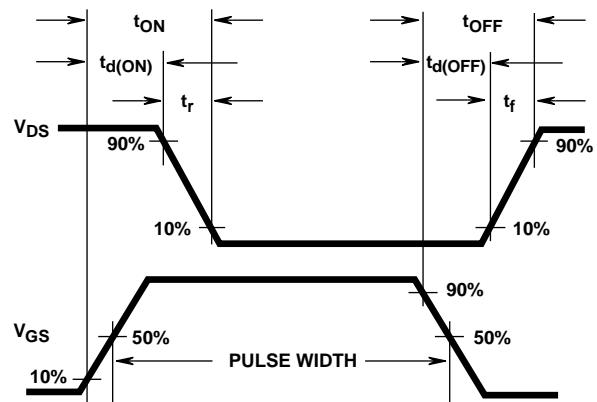

FIGURE 19. RESISTIVE SWITCHING WAVEFORMS

Soldering Precautions

The soldering process creates a considerable thermal stress on any semiconductor component. The melting temperature of solder is higher than the maximum rated temperature of the device. The amount of time the device is heated to a high temperature should be minimized to assure device reliability. Therefore, the following precautions should always be observed in order to minimize the thermal stress to which the devices are subjected.

1. Always preheat the device.
2. The delta temperature between the preheat and soldering should always be less than 100°C. Failure to preheat the device can result in excessive thermal stress which can damage the device.
3. The maximum temperature gradient should be less than 5°C per second when changing from preheating to soldering.
4. The peak temperature in the soldering process should be at least 30°C higher than the melting point of the solder chosen.
5. The maximum soldering temperature and time must not exceed 260°C for 10 seconds on the leads and case of the device.
6. After soldering is complete, the device should be allowed to cool naturally for at least three minutes, as forced cooling will increase the temperature gradient and may result in latent failure due to mechanical stress.
7. During cooling, mechanical stress or shock should be avoided.

RF1K49088

Temperature Compensated PSPICE Model for the RF1K49088

SUBCKT RF1K49088 2 1 3; rev 7/21/94

CA 12 8 1.081e-9
 CB 15 14 1.138e-9
 CIN 6 8 0.673e-9

DBODY 7 5 DBDMOD
 DBREAK 5 11 DBKMOD
 DPLCAP 10 5 DPLCAPMOD

EBREAK 11 7 17 18 34.1
 EDS 14 8 5 8 1
 EGS 13 8 6 8 1
 ESG 6 10 6 8 1
 EVTO 20 6 18 8 1

IT 8 17 1

LDRAIN 2 5 1e-9
 LGATE 1 9 1.233e-9
 LSOURCE 3 7 0.452e-9

MOS1 16 6 8 8 MOSMOD M = 0.99
 MOS2 16 21 8 8 MOSMOD M = 0.01

RBREAK 17 18 RBKMOD 1
 RDRAIN 5 16 RDSMOD 1.408e-3
 RGATE 9 20 3.33
 RIN 6 8 1e9
 RSOURCE 8 7 RDSMOD 20e-3
 RVTO 18 19 RVTOMOD 1

S1A 6 12 13 8 S1AMOD
 S1B 13 12 13 8 S1BMOD
 S2A 6 15 14 13 S2AMOD
 S2B 13 15 14 13 S2BMOD

VBAT 8 19 DC 1
 VTO 21 6 0.211

.MODEL DBDMOD D (IS = 2.82e-13 RS = 1.72e-2 TRS1 = 1.58e-3 TRS2 = 1.23e-7 CJO = 9.19e-10 TT = 2.03e-8)
 .MODEL DBKMOD D (RS = 2.65e-1 TRS1 = 5.00e-3 TRS2 = 7.09e-5)
 .MODEL DPLCAPMOD D (CJO = 0.42e-9 IS = 1e-30 N = 10)
 .MODEL MOSMOD NMOS (VTO = 2.01 KP = 15.01 IS = 1e-30 N = 10 TOX = 1 L = 1u W = 1u)
 .MODEL RBKMOD RES (TC1 = 1.02e-3 TC2 = -1.98e-6)
 .MODEL RDSMOD RES (TC1 = 3.50e-3 TC2 = 3.70e-6)
 .MODEL RVTOMOD RES (TC1 = -2.53e-3 TC2 = 8.13e-7)
 .MODEL S1AMOD VSWITCH (RON = 1e-5 ROFF = 0.1 VON = -6.2 VOFF = -3.8)
 .MODEL S1BMOD VSWITCH (RON = 1e-5 ROFF = 0.1 VON = -3.8 VOFF = -6.2)
 .MODEL S2AMOD VSWITCH (RON = 1e-5 ROFF = 0.1 VON = -1.4 VOFF = 4.1)
 .MODEL S2BMOD VSWITCH (RON = 1e-5 ROFF = 0.1 VON = 4.1 VOFF = -1.4)

.ENDS

NOTE: For further discussion of the PSPICE model, consult **A New PSPICE Sub-circuit for the Power MOSFET Featuring Global Temperature Options**; IEEE Power Electronics Specialist Conference Records, 1991.

