

6.5 Watt Ku Band Power Amplifier

TGA2514- EPU-FL

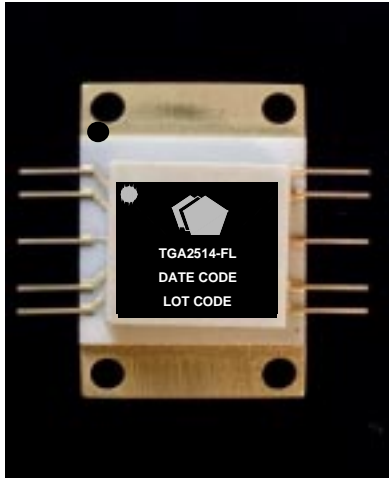

Key Features

- Frequency Range: 13 - 16 GHz
- 38 dBm Nominal Psat
- 24 dB Nominal Gain
- 14 dB Nominal Return Loss
- 0.25-um pHEMT 3MI Technology
- 10 lead flange package
- Bias Conditions: 8 V @ 2.6 A Idq
- Package dimension: 0.45 x 0.68 x 0.12 in.

Primary Applications

- Ku band VSAT Transmitter
- Point to Point Radio

Product Description

The TGA2514-EPU-FL provides 24 dB of gain and 6.5W of output power across 13-16 GHz. The TGA2514-EPU-FL is designed using TriQuint's proven standard 0.25- μ m gate pHEMT production process.

This device is ideally suited for VSAT Transmitter and Point to Point Radio applications. The flange lead package has a high thermal conductivity copper alloy base.

Evaluation Boards are available.

Measured Data

Bias Conditions: Vd = 8 V, Idq = 2.6A

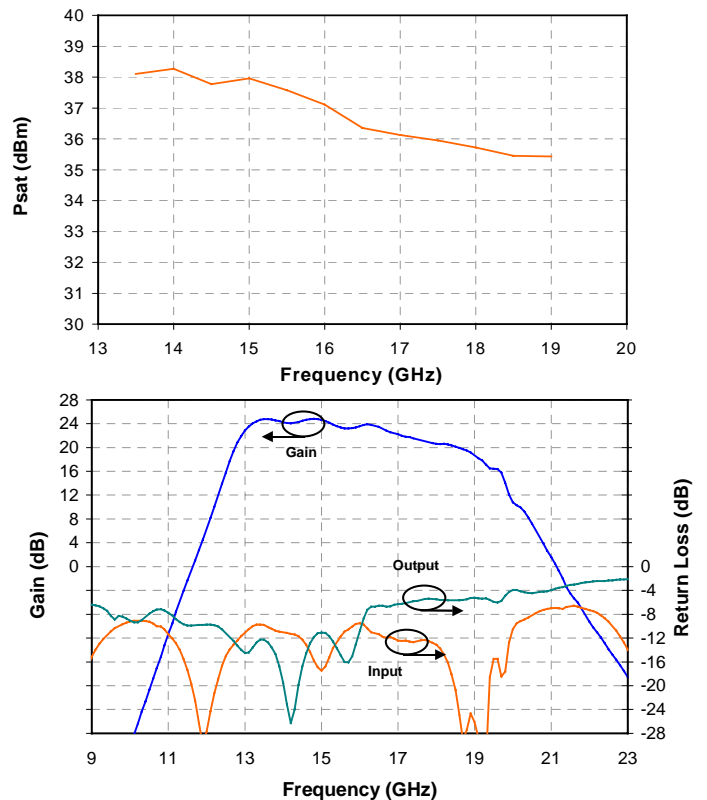

Note: Devices designated as EPU are typically early in their characterization process prior to finalizing all electrical and process specifications. Specifications are subject to change without notice.

**TABLE I
MAXIMUM RATINGS**

Symbol	Parameter <u>1/</u>	Value	Notes
V ⁺	Positive Supply Voltage	9 V	<u>2/</u>
V ⁻	Negative Supply Voltage Range	-5V TO -0.35V	
I ⁺	Positive Supply Current	4 A	<u>2/</u>
I _G	Gate Supply Current	113 mA	
P _{IN}	Input Continuous Wave Power	30.3 dBm	<u>2/</u>
P _D	Power Dissipation	20.8 W	<u>2/</u> , <u>3/</u>
T _{CH}	Operating Channel Temperature	150 °C	<u>4/</u>
T _M	Mounting Temperature (30 Seconds)	210 °C	
T _{STG}	Storage Temperature	-65 to 150 °C	

- 1/ These ratings represent the maximum operable values for this device.
- 2/ Combinations of supply voltage, supply current, input power, and output power shall not exceed P_D.
- 3/ When operated at this bias condition with a base plate temperature of 70 °C, the median life is 1E+6 hours.
- 4/ Junction operating temperature will directly affect the device median time to failure (T_M). For maximum life, it is recommended that junction temperatures be maintained at the lowest possible levels.

Note: Devices designated as EPU are typically early in their characterization process prior to finalizing all electrical and process specifications. Specifications are subject to change without notice.

TABLE II
RF CHARACTERIZATION TABLE
($T_A = 25^\circ\text{C}$, Nominal)
($V_d = 8\text{V}$, $I_d = 2.6\text{ A}$)

SYMBOL	PARAMETER	TEST CONDITION	TYPICAL	UNITS
Gain	Small Signal Gain	$f = 13\text{-}16\text{ GHz}$	24	dB
IRL	Input Return Loss	$f = 13\text{-}16\text{ GHz}$	14	dB
ORL	Output Return Loss	$f = 13\text{-}16\text{ GHz}$	14	dB
Psat	Saturated Power	$f = 13\text{-}16\text{ GHz}$	38	dBm

TABLE III
THERMAL INFORMATION

Parameter	Test Conditions	T_{CH} ($^\circ\text{C}$)	$R_{\theta JC}$ ($^\circ\text{C}/\text{W}$)	T_M (HRS)
$R_{\theta JC}$ Thermal Resistance (channel to backside of package)	$V_d = 8\text{ V}$ $I_D = 2.6\text{ A}$ (Quiescent) $P_{diss} = 20.8\text{ W}$	150	3.9	1 E+6

Note: Package backside SnPb soldered to carrier at 70°C baseplate temperature. At saturated output power, the DC power consumption is 28.8 W with 6.5 W RF power delivered to the load. Power dissipated is 22.3 W and the temperature rise in the channel is 87°C . The baseplate temperature must be reduced to 63°C to remain below the 150°C maximum channel temperature.

Note: Devices designated as EPU are typically early in their characterization process prior to finalizing all electrical and process specifications. Specifications are subject to change without notice.

Measured Fixture Data
Bias Conditions: $V_d = 8\text{ V}$, $I_{dq} = 2.6\text{ A}$

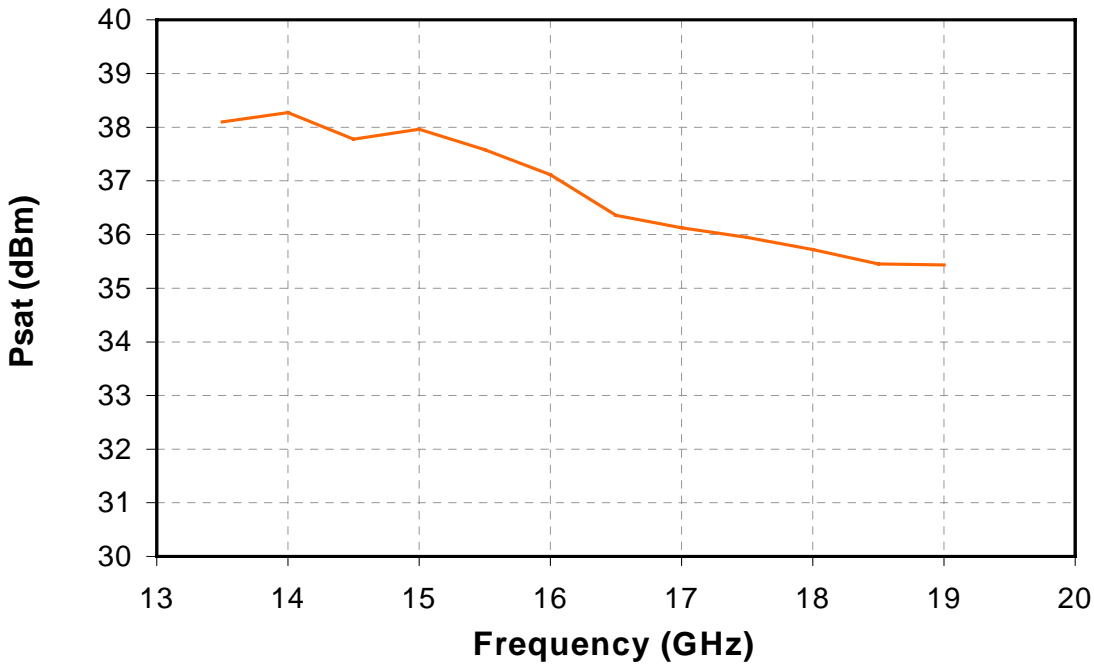
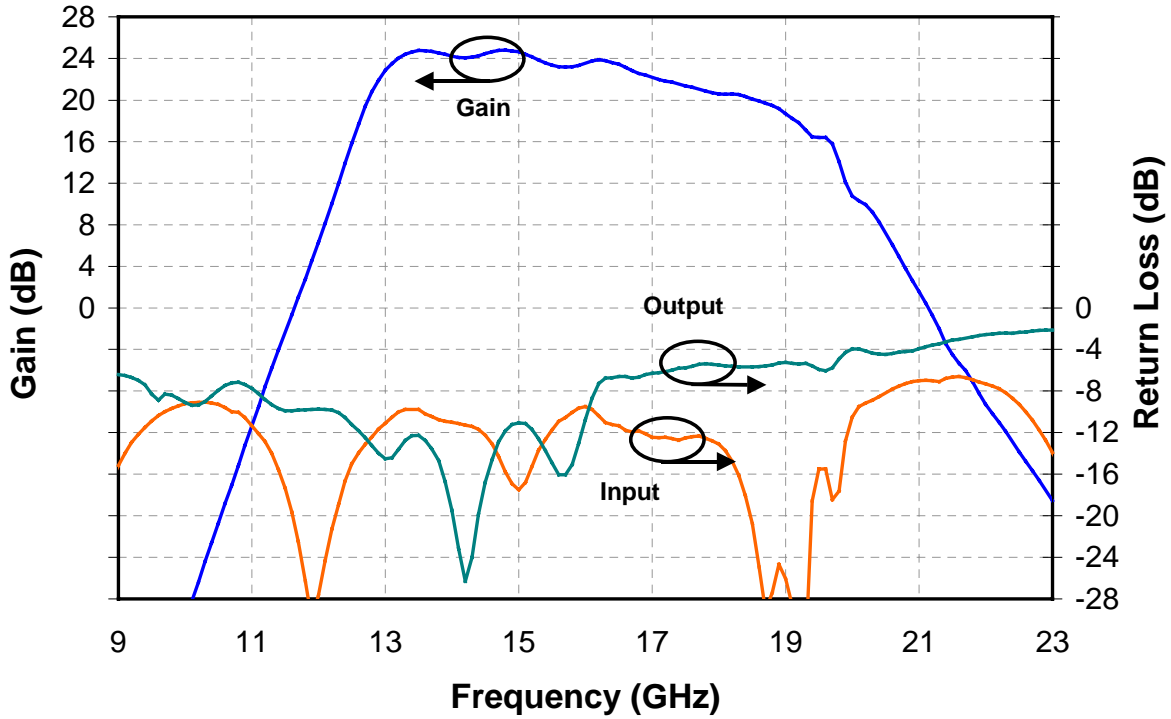

Note: Devices designated as EPU are typically early in their characterization process prior to finalizing all electrical and process specifications. Specifications are subject to change without notice.

Measured Fixture Data
Bias Conditions: $V_d = 8\text{ V}$, $I_{dQ} = 2.6\text{ A}$

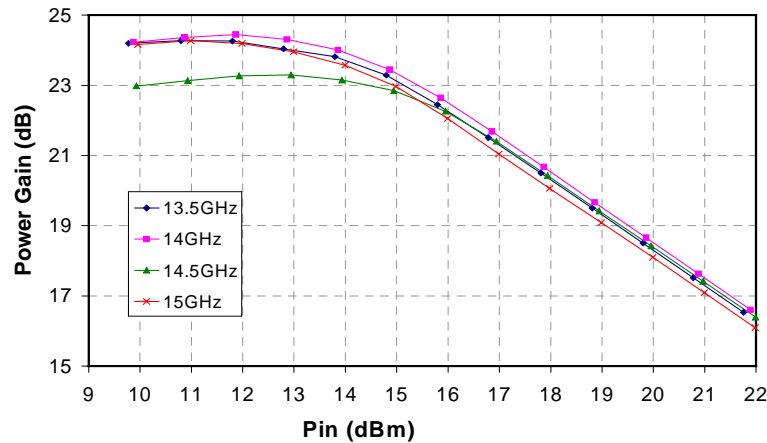
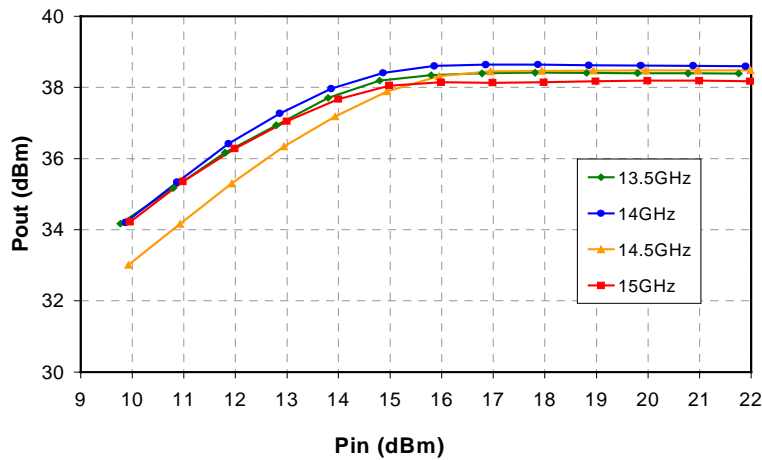
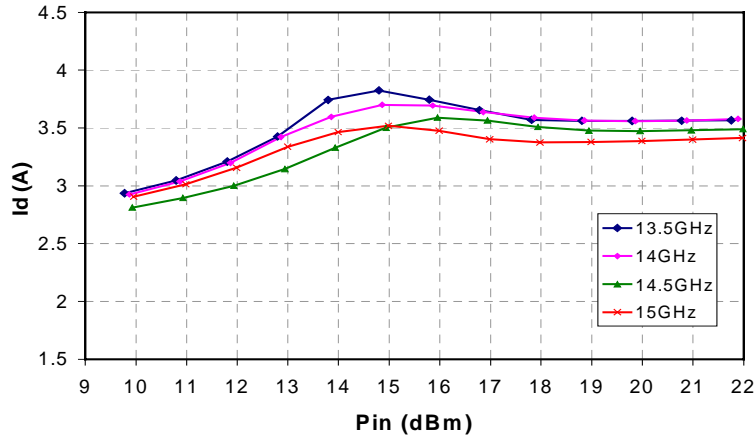

Note: Devices designated as EPU are typically early in their characterization process prior to finalizing all electrical and process specifications. Specifications are subject to change without notice.

Evaluation Board Drawing

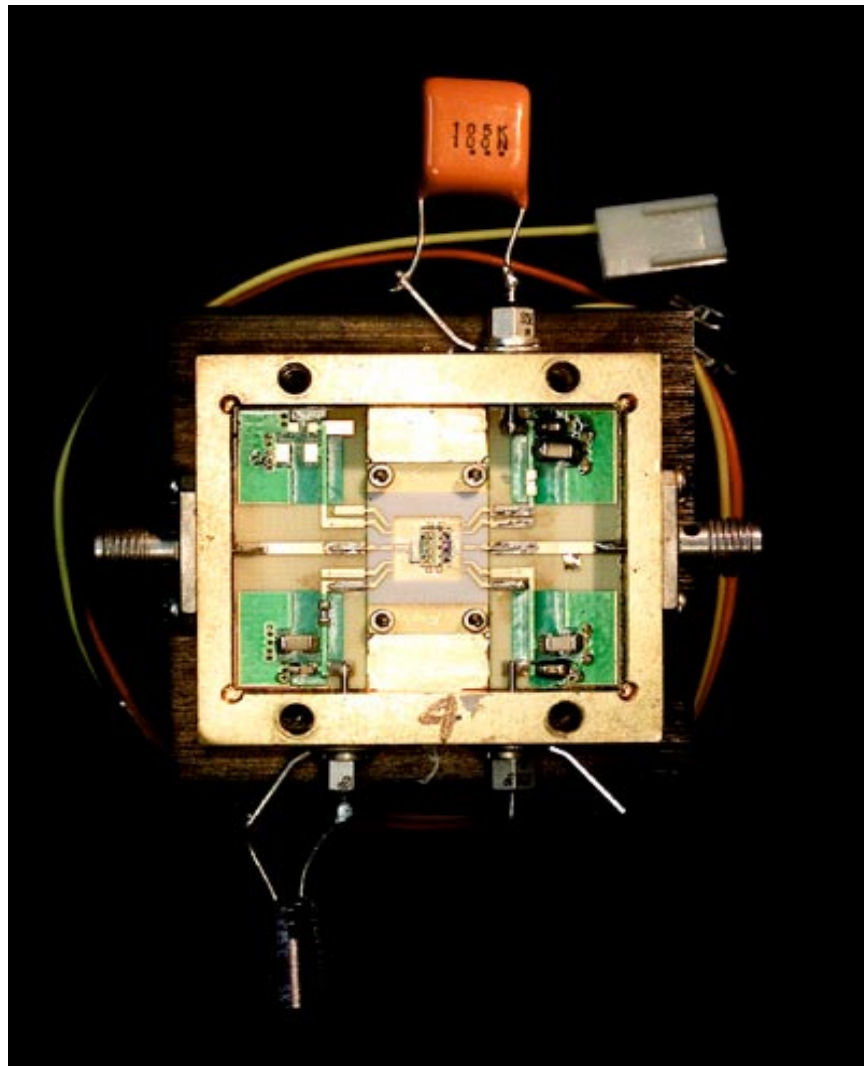

Notes:

1. V_d must remain below 9V to comply with maximum rating value.
2. The drain supply must be connected to both sides of the evaluation block.
3. The cooling fan must be powered at all times when the device is under bias.
4. Connect fan supply red/black to +12V. It requires ~100mA.

GaAs MMIC devices are susceptible to damage from Electrostatic Discharge. Proper precautions should be observed during handling, assembly and test.

Note: Devices designated as EPU are typically early in their characterization process prior to finalizing all electrical and process specifications. Specifications are subject to change without notice.

Assembly Diagram

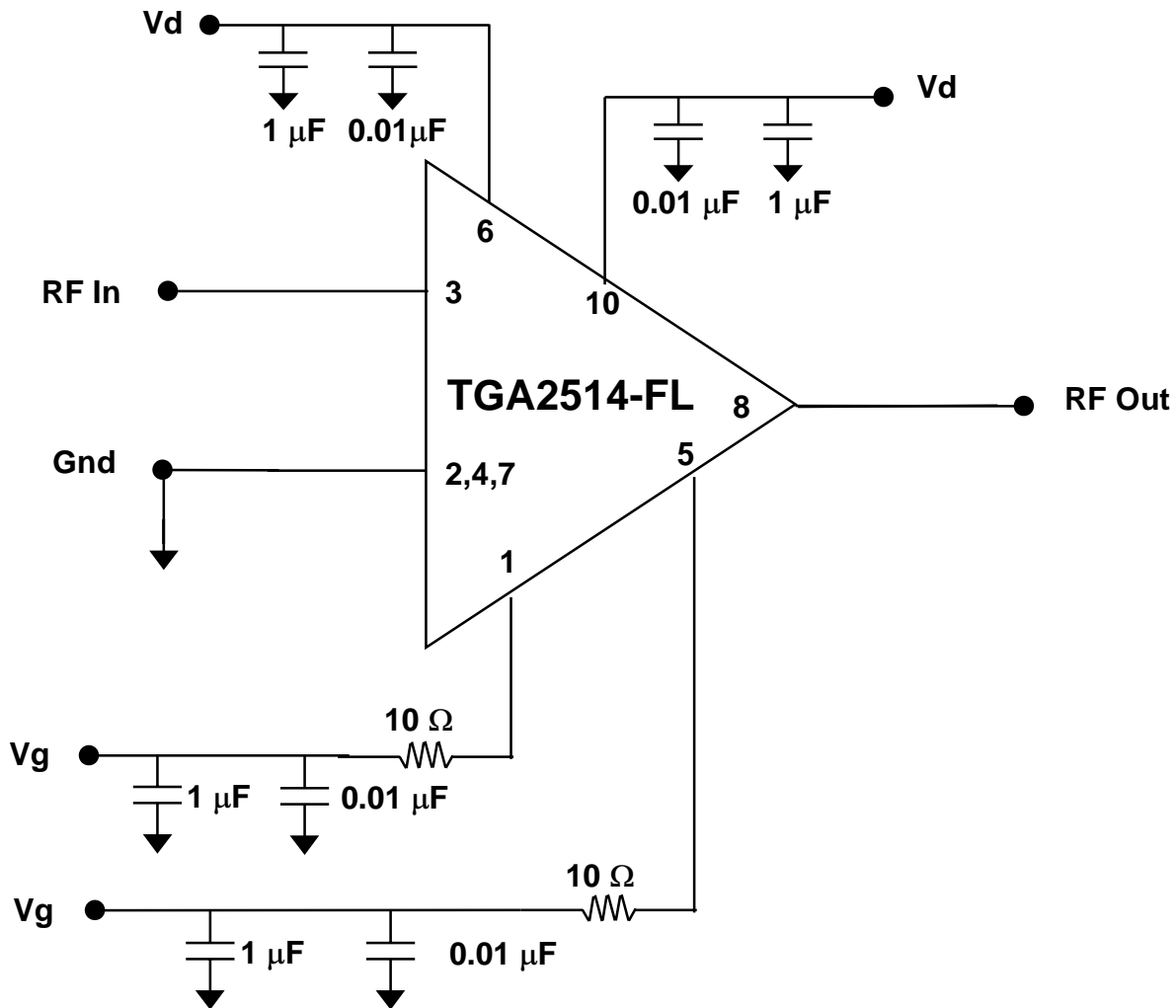

Note: Vg can be biased from either Pin 1 or Pin 5

GaAs MMIC devices are susceptible to damage from Electrostatic Discharge. Proper precautions should be observed during handling, assembly and test.

Note: Devices designated as EPU are typically early in their characterization process prior to finalizing all electrical and process specifications. Specifications are subject to change without notice.

Mechanical Drawing TGA2514-EPU-FL

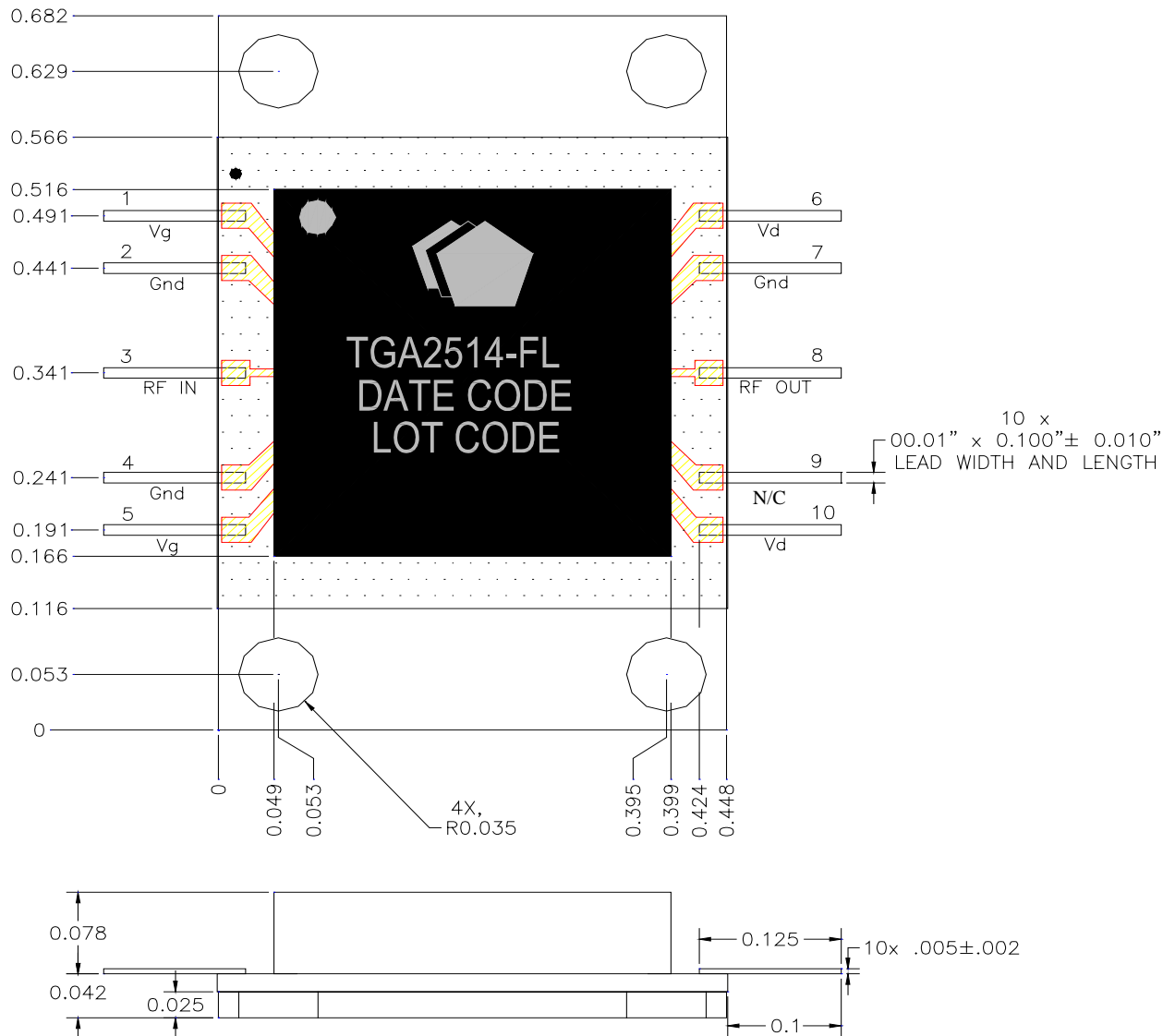

Note: All dimensions are in inches with ±0.005 tolerance

GaAs MMIC devices are susceptible to damage from Electrostatic Discharge. Proper precautions should be observed during handling, assembly and test.

Note: Devices designated as EPU are typically early in their characterization process prior to finalizing all electrical and process specifications. Specifications are subject to change without notice.

Assembly of a TGA2514-EPU-FL Surface Mount Package onto a Motherboard

1. Clean the motherboard or module with acetone. Rinse with alcohol and DI water. Allow the circuit to fully dry.
2. To improve the thermal and RF performance, we recommend a heat sink attached to the bottom of the package and apply SnPb or equivalent solder to the bottom of TGA2514.
3. Apply SnPb or equivalent solder to each pin of TGA2514 and to the backside of the package.
4. Clean the assembly with alcohol.

Ordering Information

Part	Package Style
TGA2514-EPU-FL	Flange (package bolted down)

GaAs MMIC devices are susceptible to damage from Electrostatic Discharge. Proper precautions should be observed during handling, assembly and test.

Note: Devices designated as EPU are typically early in their characterization process prior to finalizing all electrical and process specifications. Specifications are subject to change without notice.