

低損失超高速ダイオード

LOW LOSS SUPER HIGH SPEED RECTIFIER

■外形寸法：Outline Drawings

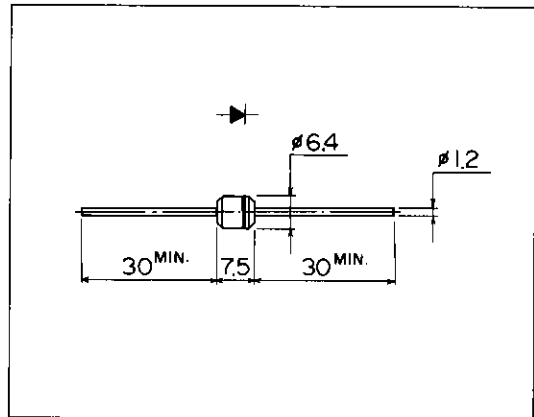

■特長：Features

- 低 V_F
Low V_F
- スイッチングスピードが非常に速い
Super high speed switching.
- プレーナー技術による高信頼性
High reliability by planer design.

■用途：Applications

- 高速電力スイッチング
High speed power switching.

■表示：Marking

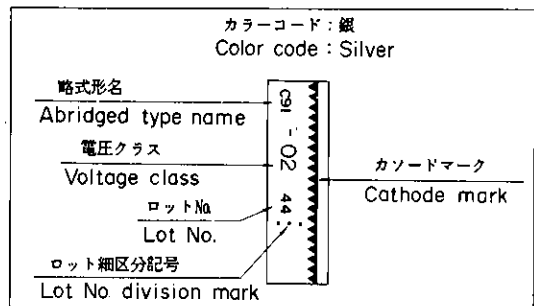

■定格と特性：Maximum Ratings and Characteristics

●絶対最大定格：Absolute Maximum Ratings

Items	Symbols	Conditions	Ratings	Units
ピーク繰り返し逆電圧 Repetitive Peak Reverse Voltage	V_{RRM}		200	V
平均順電流 Average Forward Current	$I_{F(AV)}$	方形波, duty = 1/2, $T_a = 25^\circ\text{C}$ Square wave	3.0	A
サージ電流 Surge Current	I_{FSM}	正弦波 Sine wave 10ms	50	A
接合温度 Operating Junction Temperature	T_j		-40 ~ +150	$^\circ\text{C}$
保存温度 Storage Temperature	T_{stg}		-40 ~ +150	$^\circ\text{C}$

●電気的特性(特に指定がない限り周囲温度 $T_a = 25^\circ\text{C}$ とする)

Electrical Characteristics ($T_a = 25^\circ\text{C}$ Unless otherwise specified)

Items	Symbols	Conditions	Max.	Units
順電圧 Forward Voltage Drop	V_{FM}	$I_{FM} = 3.0\text{A}$	0.95	V
逆電流 Reverse Current	I_{RRM}	$V_R = V_{RRM}$	100	μA
逆回復時間 Reverse Recovery Time	t_{rr}	$I_F = 0.1\text{A}$, $I_R = 0.2\text{A}$, $I_{rec} = 0.05\text{A}$	35	ns

■特性曲線：Characteristics

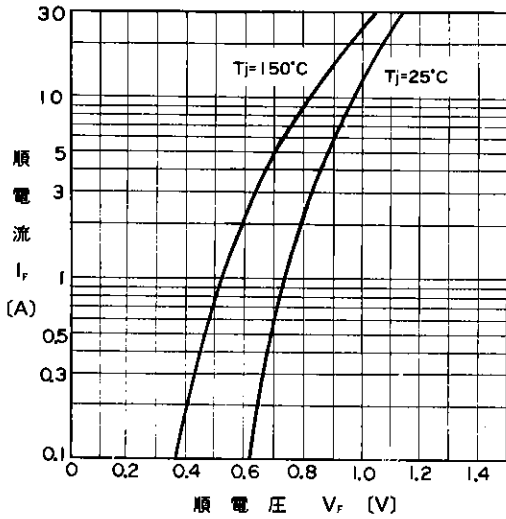

順特性 (代表特性)
Forward Characteristics

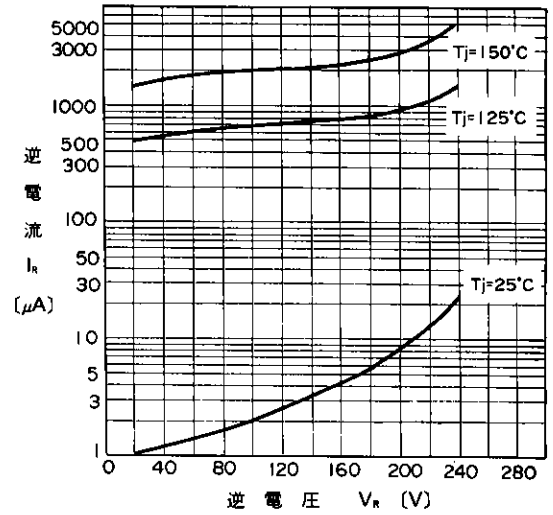

逆特性 (代表特性)
Reverse Characteristics

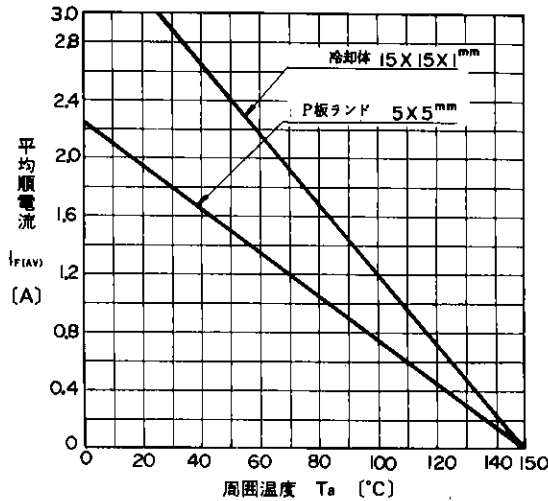

平均順電流—周囲温度特性
Current Derating ($I_{F(AV)}-T_a$)

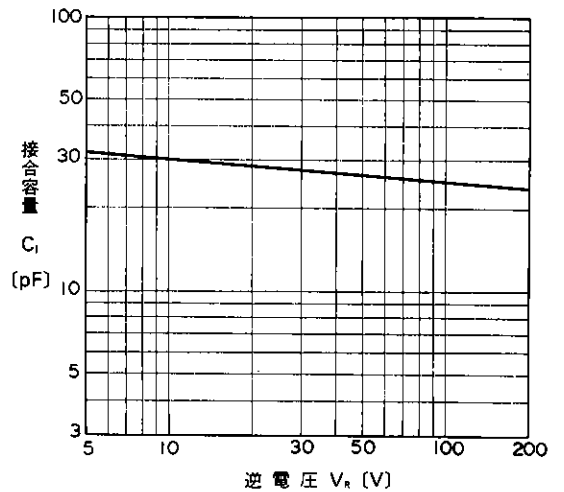

接合容量特性 (代表特性)
Junction Capacitance

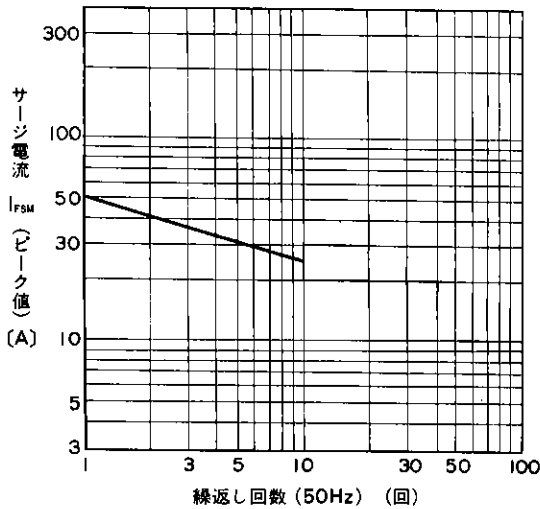

サージ電流耐量
Surge Capability

A

For more information, contact:

Collmer Semiconductor, Inc.

P.O. Box 702708

Dallas, TX 75370

972-733-1700

972-381-9991 Fax

<http://www.collmer.com>