

INTERNATIONAL RECTIFIER



350PJT SERIES

1200A $I_{T(GQ)}$ Gate Turn-Off Hockey Puck SCRs

Major Ratings

	350PJT	Units
$I_{T(GQ)}$	1200	A
$I_T(RMS)$	550	A
$I_T(AV)$	350	A
@ Max. T_C	80	$^{\circ}C$
I_{TSM}	@ 50 Hz	4500
	@ 60 Hz	4700
I^2_t	@ 50 Hz	101,000
	@ 60 Hz	92,000
I_{GT}	2	A
dv/dt	1000	V/ μs
di/dt	600	A/ μs
t_{gq}	15	μs
T_J	-40 to 125	$^{\circ}C$
V_{RRM}, V_{DRM}	1000 to 1600V	V

Description/Features

The 350PJT Series of GTO (gate turn-off) thyristors is designed for power control applications such as uninterruptible power supplies (UPS), variable speed ac motor drives, etc. Since they can be turned off by a negative current pulse to the gate, devices in the 350PJT Series allow reductions in overall size, weight, cost and acoustical noise when compared to conventional thyristors that require bulky commutating circuits.

- 350A average current.
- 1200A controllable on-state current.
- Maximum turn-off time of 15 μsec .
- Critical dv/dt of 1000 V/ μsec .
- Available with maximum repetitive peak off-state voltage (V_{DRM}) to 1600V.

CASE STYLE AND DIMENSIONS

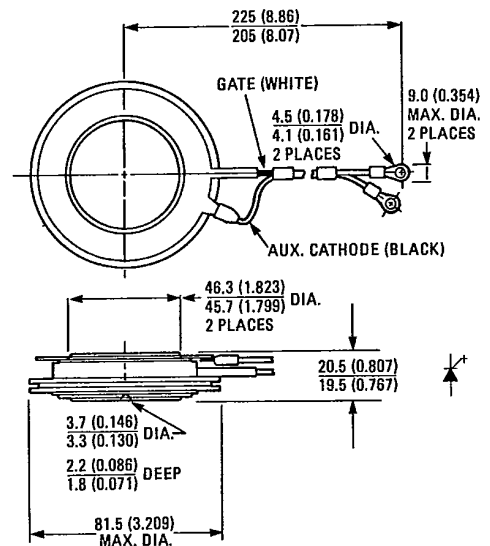
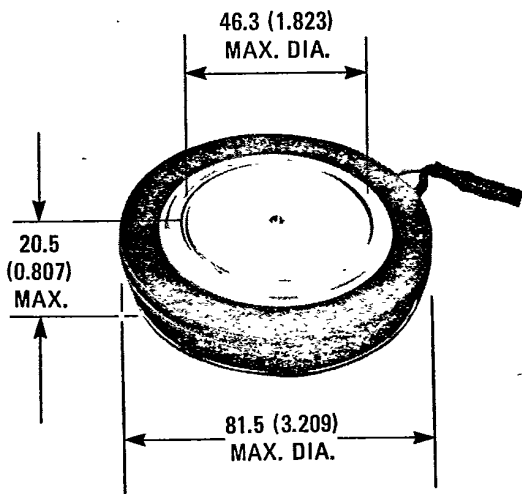

IR Case Style A-38
Dimensions in Millimeters and (Inches)

VOLTAGE RATINGS ①

Part Number	V_{RRM}, V_{DRM} – Max. Repetitive Peak Reverse and Off-State Voltage (V) ③	V_{RSM}, V_{DSM} – Max. Non-Repetitive Peak Reverse and Off-State Voltage $t_p \leq 5$ ms (V)
	$T_J = -40^\circ\text{C}$ to 125°C	$T_J = 25^\circ\text{C}$ to 125°C
350PJT100	1000	1200
350PJT120	1200	1400
350PJT140	1400	1600
350PJT160	1600	1750

ELECTRICAL SPECIFICATIONS

	350PJT	Units	Conditions
ON-STATE			
$I_T(\text{RMS})$ Nominal RMS on-state current	550	A	
$I_T(\text{AV})$ Max. average on-state current @ Max. T_C	350	A	180° half sine wave conduction.
	80	°C	
I_{TGQ} Max. controllable peak on-state current	1200	A	$T_J = 125^\circ\text{C}$, $V_{DM} = 1/2 V_{DRM}$, $G_{GQ} = 5$, $C_S = 3.0 \mu\text{F}$. Note: $V_S \leq 600\text{V}$ @ $T_J = 25^\circ\text{C}$. $V_S \leq 500\text{V}$ @ $T_J = 125^\circ\text{C}$. (V_S is the voltage spike which appears on the dynamic on-state voltage trace during fall time.) ②
I_{TSM} Max. peak one cycle, non-repetitive surge current	4500	A	50 Hz half cycle sine wave or 6 ms rectangular pulse 60 Hz half cycle sine wave or 5 ms rectangular pulse Following any rated load condition, and with rated V_{RRM} applied following surge. SCR turned fully on.
	4700		
I^2t Max. I^2t capability for fusing	101,000	A^2s	$t = 10$ ms Rated V_{RRM} applied following surge, $t = 8.3$ ms initial $T_J \leq 125^\circ\text{C}$.
	92,000		
V_{TM} Max. peak on-state voltage	3.42	V	$T_J = 25^\circ\text{C}$, $I_T(\text{AV}) = 350\text{A}$ (1100A peak), $I_G = 4\text{A}$
I_L Typical latching current	30	A	$T_J = 25^\circ\text{C}$
I_H Typical holding current	30	A	$T_J = 25^\circ\text{C}$
BLOCKING			
dv/dt Min. critical rate-of-rise of off-state voltage	1000	$V/\mu\text{s}$	Gate voltage = -2V $T_J = 125^\circ\text{C}$ Gate-to-cathode resistance = 2Ω $V_D = 1/2 V_{DRM}$
	400		
I_{DM} & I_{RM} Max. peak off-state and reverse current	80	mA	$T_J = 125^\circ\text{C}$, $V_{DM} = \text{rated } V_{DRM}$. Peak off-state current applies for -2V or more negative gate voltage or for gate-to-cathode resistance = 2Ω .
SWITCHING			
di/dt Max. repetitive rate-of-rise of turned-on current	600	$A/\mu\text{s}$	$di_G/dt \geq 5 A/\mu\text{s}$, $+I_{GM} \geq 10\text{A}$, $I_{TM} \leq 1200\text{A}$, $V_D \leq 1/2 V_{DRM}$.
t_{gt} Max. turn-on time	8	μs	t_{gt} is measured from instant at which $i_G = 0.1I_{GM}$ to instant at which $v_D = 0.1V_D$ with resistive load. $T_J = 125^\circ\text{C}$, $I_T = 1200\text{A}$, $+I_{GM} = 10\text{A}$, $di_G/dt = 5 A/\mu\text{s}$, $V_D = 1/2 V_{DRM}$.
t_{on} Min. permissible on-time	16	μs	t_{on} is the time necessary to ensure that all cathode islands are in conduction. $T_J = 125^\circ\text{C}$, $I_T = 1200\text{A}$, $V_D = 1/2 V_{DRM}$, $I_{GM} = 10\text{A}$, $di_G/dt = 60 A/\mu\text{s}$.
t_{gq} Max. gate-controlled turn-off time	15	μs	t_{gq} is measured from instant at which $I_G = 24\text{A}$ to instant at which $I_T = 120\text{A}$ with resistive load. $T_J = 125^\circ\text{C}$, $I_T = 1200\text{A}$, $di_G/dt = 60 A/\mu\text{s}$, $G_{GQ} = 5$. ②

① Peak off-state voltages apply for -2V or more negative gate voltage or for gate-to-cathode resistance = 2Ω .

② $G_{GQ} = \frac{I_T}{\text{applied } I_{GQ}}$ = forced turn-off gain. I_T = on-state current. Applied I_{GQ} = maximum negative gate current during turn-off interval.

③ Peak reverse voltages apply for zero or negative gate voltage.



ELECTRICAL SPECIFICATIONS (Continued)

		350PJT	Units	Conditions
SWITCHING (Continued)				
t_f	Max. fall time	1.2	μs	t_f is measured from instant at which $I_T = 1080A$ to instant at which $I_T = 120A$ with resistive load. $T_J = 125^\circ C$, $I_T = 1200A$, $V_D = 1/2 V_{DRM}$, $di_G/dt = 60 A/\mu s$, $G_{GQ} = 5$. (2)
t_{off}	Min. permissible off-time	80	μs	t_{off} is measured from the instant at which the turn-off pulse is applied to the gate to the earliest instant at which the GTO may be retriggered. $T_J = 125^\circ C$, $I_T = 1200A$, $di_G/dt = 60 A/\mu s$, $G_{GQ} = 5$. (2)
TRIGGERING				
$P_{GF(AV)}$	Max. average forward gate power	30	W	Forward gate power is produced by positive gate current, reverse gate power is produced by negative gate current.
P_{GRM}	Max. peak reverse gate power	18,000	W	
$P_{GR(AV)}$	Max. average reverse gate power	80	W	
$+I_{GM}$	Max. peak positive gate current	100	A	$t_p \leq 100 \mu s$. Positive gate current may not be applied during reverse recovery interval.
$-I_{GM}$	Max. peak negative gate current	50	mA	$T_J = 125^\circ C$, $-V_{GM} = \text{rated } -V_{GRM}$, SCR blocking.
$-V_{GRM}$	Max. repetitive peak negative gate voltage	20	V	SCR blocking.
I_{GT}	Max. required DC gate current to trigger	4.6	A	$T_C = -40^\circ C$
		2.0		$T_C = 25^\circ C$
		0.5		$T_C = 125^\circ C$
V_{GT}	Max. required DC gate voltage to trigger	1.25	V	$T_C = -40^\circ C$
		1.0		$T_C = 25^\circ C$

THERMAL-MECHANICAL SPECIFICATIONS

T_J	Junction operating temperature range	-40 to 125	$^\circ C$	
T_{stg}	Storage temperature range	-40 to 125	$^\circ C$	
R_{thJC}	Max. internal thermal resistance, junction-to-case	0.035	deg. C/W	DC operation; double side cooled, mounting force = 11750N (2650lbf).
R_{thCS}	Thermal resistance, one pole piece to one heat dissipator	0.02	deg. C/W	Mounting surface smooth, flat and greased.
T	Mounting force	Min.	10,600 (2400)	N (lbf)
		Max.	12,900 (2900)	
wt	Approximate weight	360 (12.7)	g (oz.)	
	Case Style	IR: A-38		

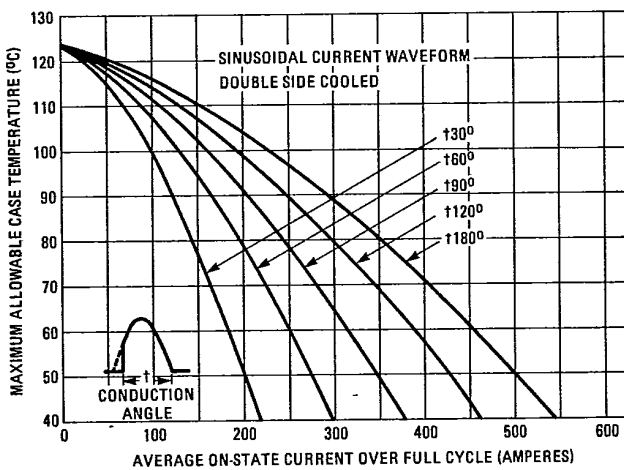

Fig. 1 – Average On-State Current Vs. Maximum Allowable Case Temperature (Sinusoidal Current Waveform)

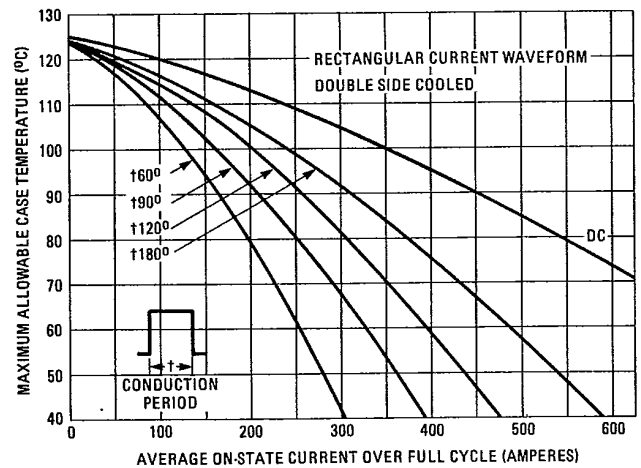

Fig. 2 – Average On-State Current Vs. Maximum Allowable Case Temperature (Rectangular Current Waveform)

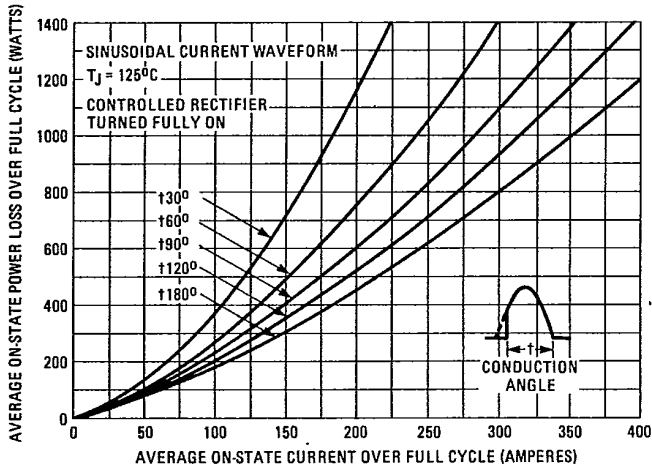

Fig. 3 - Maximum Low Level On-State Power Loss Vs. Average On-State Current (Sinusoidal Current Waveform)

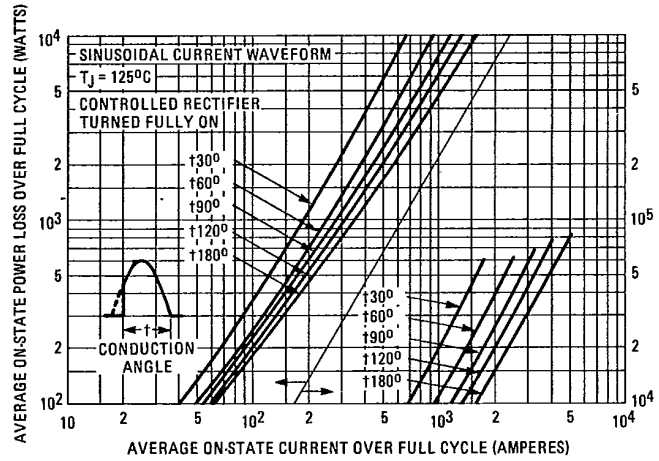

Fig. 4 - Maximum High Level On-State Power Loss Vs. Average On-State Current (Sinusoidal Current Waveform)

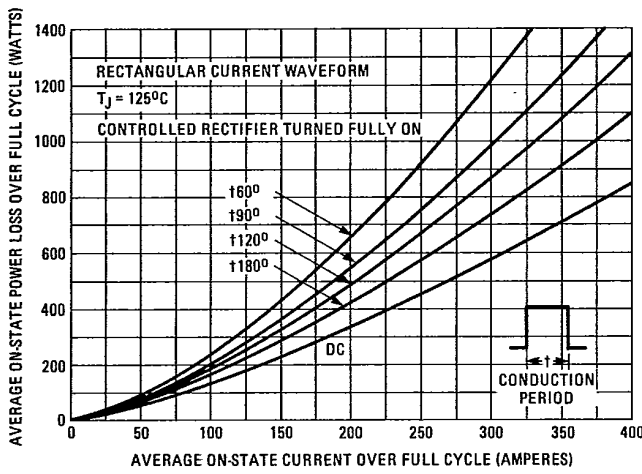

Fig. 5 - Maximum Low Level On-State Power Loss Vs. Average On-State Current (Rectangular Current Waveform)

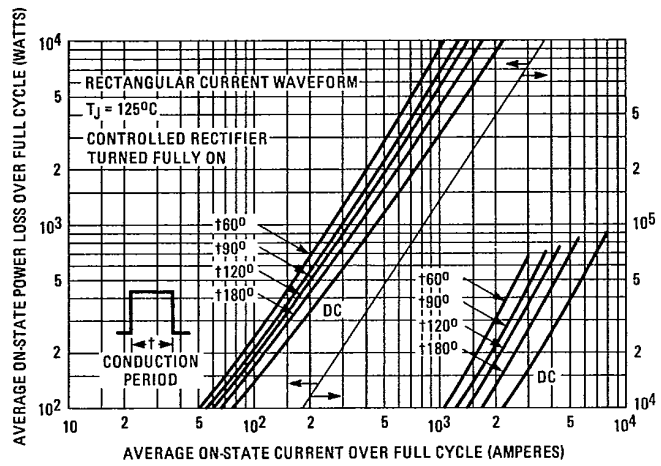

Fig. 6 - Maximum High Level On-State Power Loss Vs. Average On-State Current (Rectangular Current Waveform)

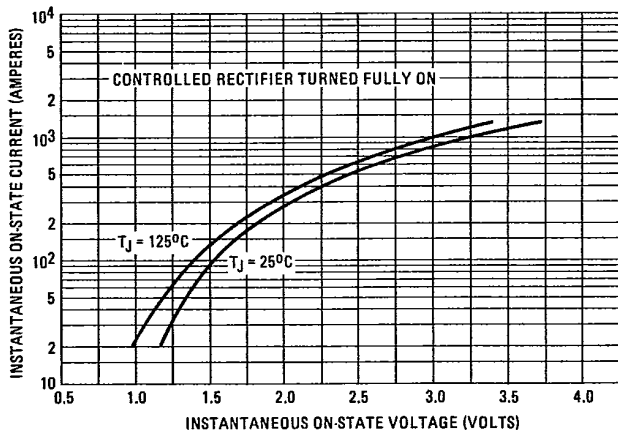

Fig. 7 - Maximum Instantaneous On-State Voltage Vs. Instantaneous On-State Current

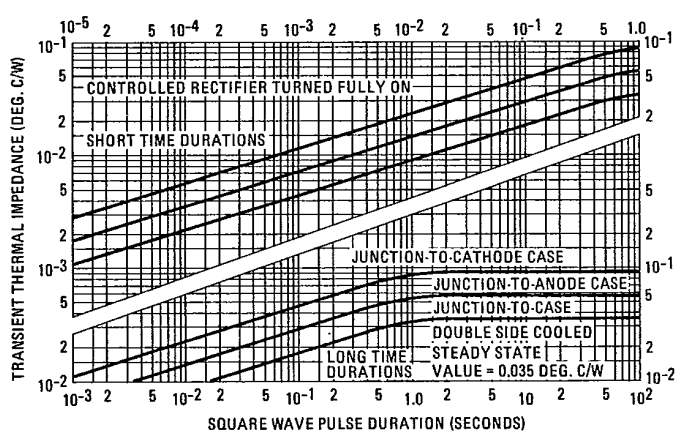

Fig. 8 - Maximum Transient Thermal Impedance Vs. Square Wave Pulse Duration

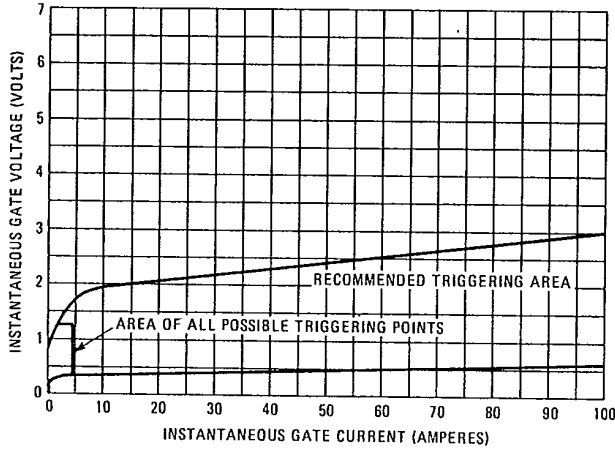

Fig. 9 – Gate Characteristics

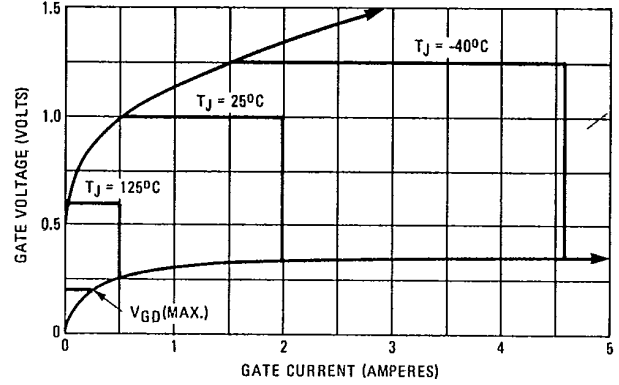

Fig. 9a – Areas of All Possible Triggering Points

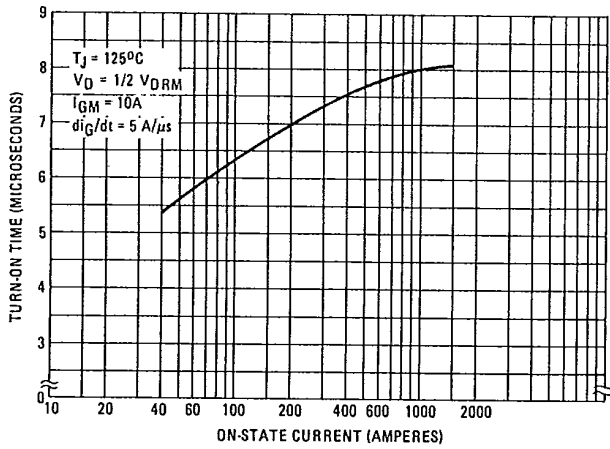

Fig. 10 – Turn-On Time Vs. On-State Current

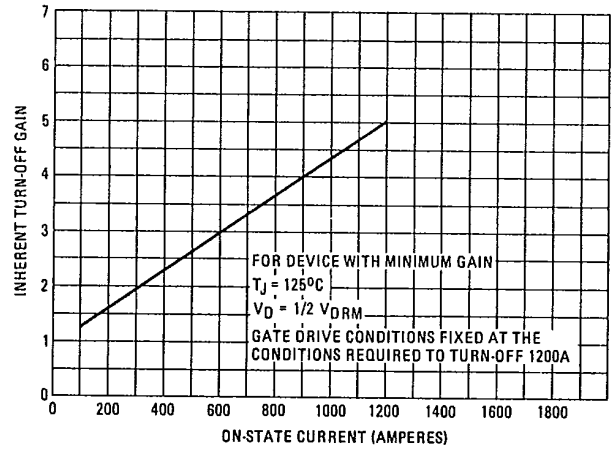

Fig. 11 – Inherent Turn-Off Gain Vs. Instantaneous On-State Current

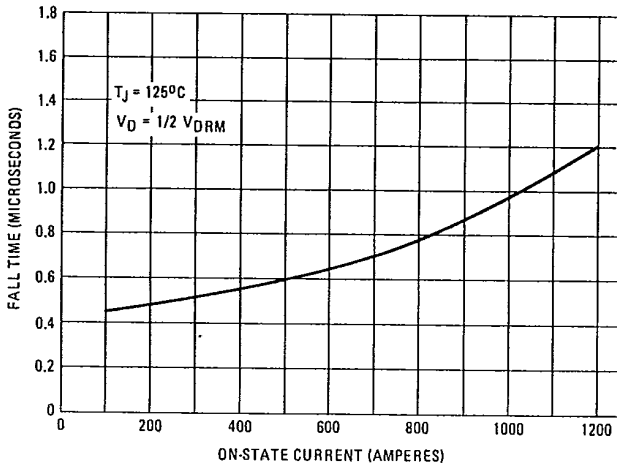

Fig. 12 – Maximum Fall Time Vs. On-State Current

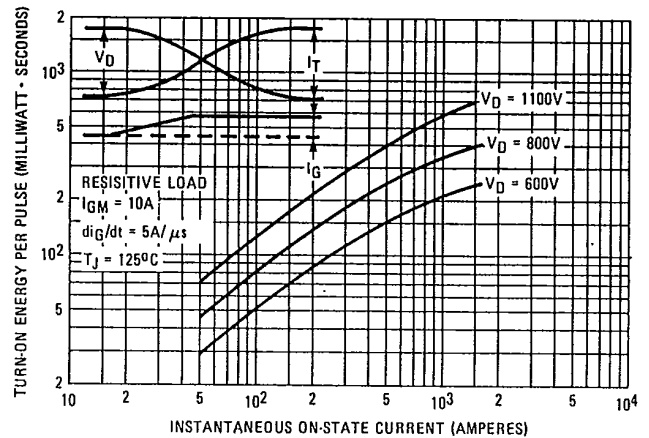

Fig. 13 – Maximum Turn-On Energy Per Pulse Vs. On-State Current

350PJT Series

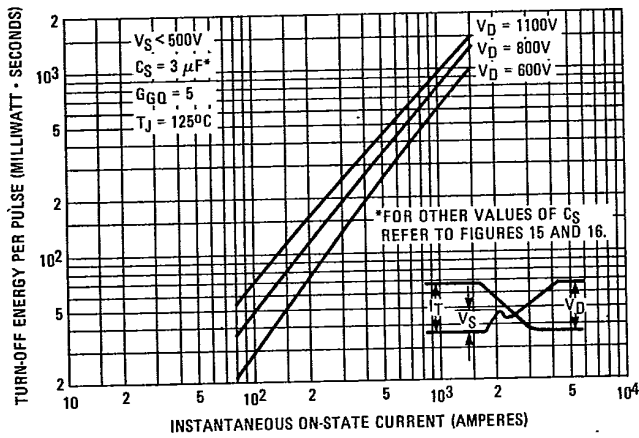

Fig. 14 - Maximum Turn-Off Energy Per Pulse Vs. On-State Current, $V_D = 600, 800 \text{ \& } 1100\text{V}$; $C_S = 3 \mu\text{F}$

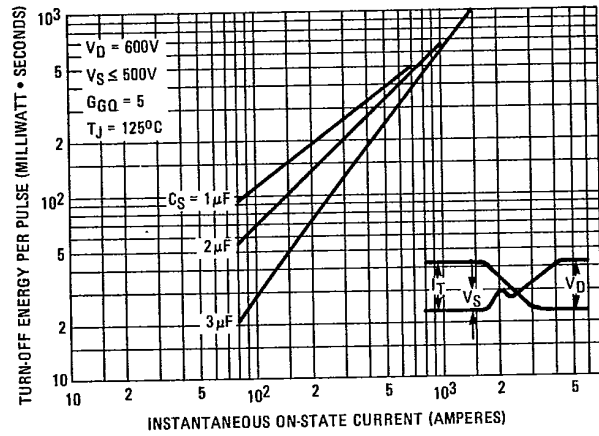

Fig. 15 - Maximum Turn-Off Energy Per Pulse Vs. On-State Current, $V_D = 600\text{V}$; $C_S = 1, 2, \text{ \& } 3 \mu\text{F}$

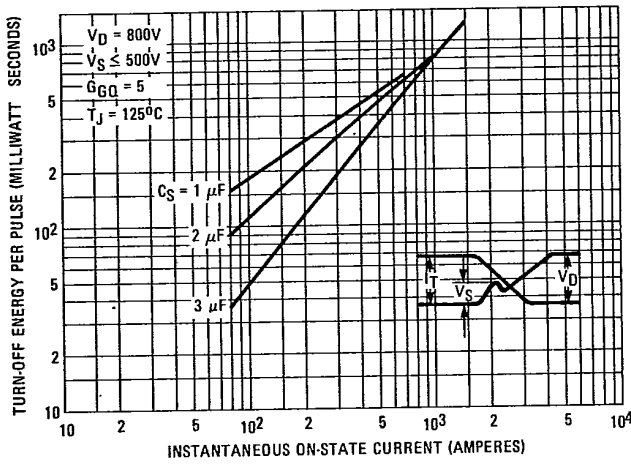

Fig. 16 - Maximum Turn-Off Energy Per Pulse Vs. On-State Current, $V_D = 800\text{V}$; $C_S = 1, 2, \text{ \& } 3 \mu\text{F}$

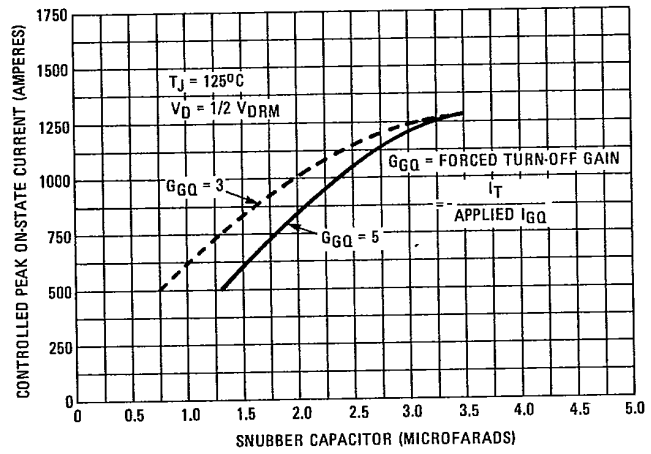

Fig. 17 - Maximum Controllable Peak On-State Current Vs. Snubber Capacitor Value

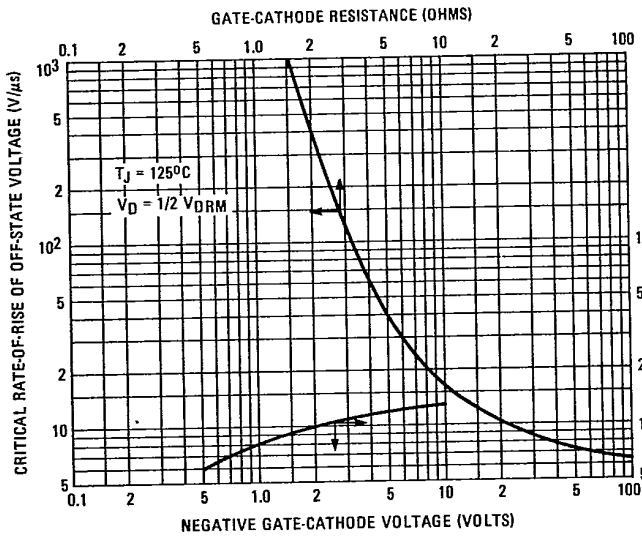

Fig. 18 - Minimum Critical Rate-of-Rise Off-State Voltage Vs. Negative Gate-Cathode Voltage and Vs. Gate-Cathode Resistance

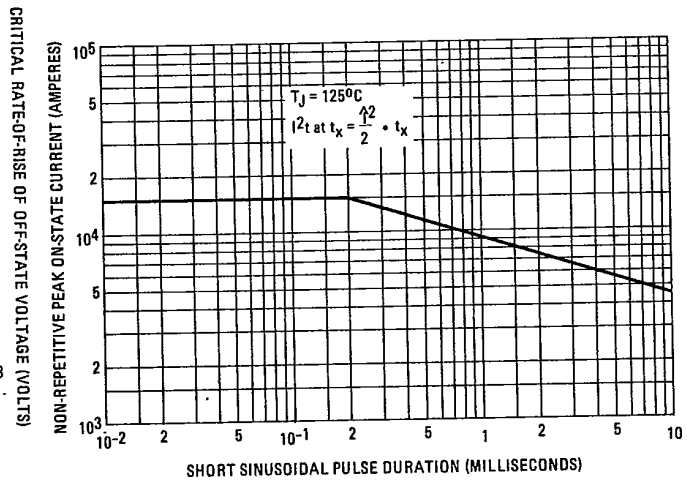
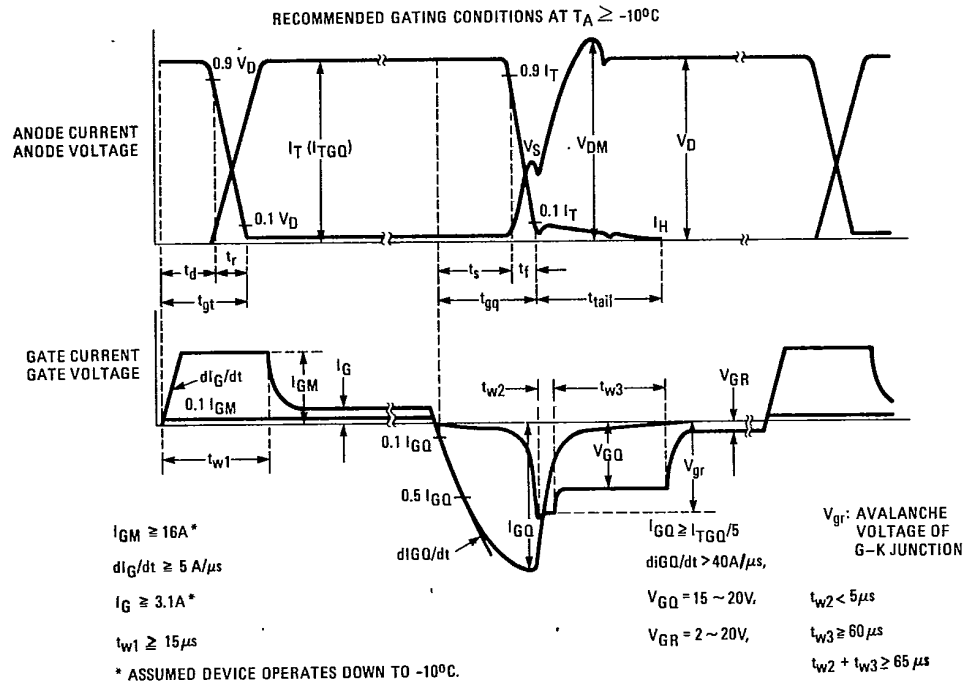

Fig. 19 - Non-Repetitive Peak On-State Current Vs. Sinusoidal Pulse Duration



SNUBBER CAPACITOR C_s (μF)	SNUBBER RESISTOR R_s (Ω)	MINIMUM ON-TIME (μs)
3.0	10	75
	5	45
2.0	10	50
	5	30
1.5	10	38
	5	23

Fig. 20 – Recommended Gating Conditions at $T_A \geq -10^\circ\text{C}$