

### FEATURES

Space-Saving SC70 and SOT-23 Packaging  
 Wide Bandwidth: 8 MHz @ 5 V  
 Low Offset Voltage: 1.2 mV Max  
 Rail-to-Rail Output Swing  
 2.7 V/ms Slew Rate  
 Unity Gain Stable  
 Single-Supply Operation: 2.7 V to 12 V

### APPLICATIONS

Portable Communications  
 Microphone Amplifiers  
 Portable Phones  
 Sensor Interface  
 Active Filters  
 PCMCIA Cards  
 ASIC Input Drivers  
 Wearable Computers  
 Battery-Powered Devices  
 Voltage Reference Buffers  
 Personal Digital Assistants

### GENERAL DESCRIPTION

The AD8519 and AD8529 are rail-to-rail output bipolar amplifiers with a unity gain bandwidth of 8 MHz and a typical voltage offset of less than 1 mV. The AD8519 brings precision and bandwidth to the SC70 and SOT-23 packages. The low supply current makes the AD8519/AD8529 ideal for battery-powered applications. The rail-to-rail output swing of the AD8519/AD8529 is larger than standard video op amps, making them useful in applications that require greater dynamic range than standard video op amps. The 2.7 V/ $\mu$ s slew rate makes the AD8519/AD8529 a good match for driving ASIC inputs such as voice codecs.

The small SC70 package makes it possible to place the AD8519 next to sensors, reducing external noise pickup.

The AD8519/AD8529 is specified over the extended industrial ( $-40^{\circ}\text{C}$  to  $+125^{\circ}\text{C}$ ) temperature range. The AD8519 is available in 5-lead SC70 and SOT-23 packages and an 8-lead SOIC surface-mount package. The AD8529 is available in 8-lead SOIC and MSOP packages.

### PIN CONFIGURATIONS

8-Lead SOIC  
 (R Suffix)

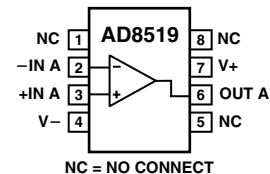

5-Lead SC70 and SOT-23  
 (KS and RT Suffixes)

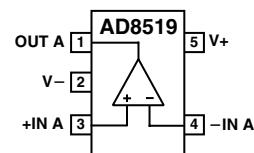

8-Lead SOIC and MSOP  
 (R and RM Suffixes)

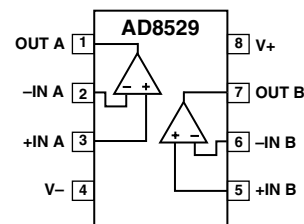

REV. C

Information furnished by Analog Devices is believed to be accurate and reliable. However, no responsibility is assumed by Analog Devices for its use, nor for any infringements of patents or other rights of third parties that may result from its use. No license is granted by implication or otherwise under any patent or patent rights of Analog Devices. Trademarks and registered trademarks are the property of their respective companies.

# AD8519/AD8529—SPECIFICATIONS

## ELECTRICAL CHARACTERISTICS ( $V_S = 5.0\text{ V}$ , $V_- = 0\text{ V}$ , $V_{CM} = 2.5\text{ V}$ , $T_A = 25^\circ\text{C}$ , unless otherwise noted.)

Parameter	Symbol	Conditions	Min	Typ	Max	Unit
<b>INPUT CHARACTERISTICS</b>						
Offset Voltage	$V_{OS}$	AD8519AKS, AD8519ART		600	1,100	$\mu\text{V}$
		$-40^\circ\text{C} \leq T_A \leq +125^\circ\text{C}$		800	1,300	$\mu\text{V}$
		AD8519AR (R-8), AD8529		600	1,000	$\mu\text{V}$
Input Bias Current	$I_B$	$-40^\circ\text{C} \leq T_A \leq +125^\circ\text{C}$			1,100	$\mu\text{V}$
					300	$\text{nA}$
Input Offset Current	$I_{OS}$	$-40^\circ\text{C} \leq T_A \leq +125^\circ\text{C}$			400	$\text{nA}$
					$\pm 50$	$\text{nA}$
Input Voltage Range	$V_{CM}$	$-40^\circ\text{C} \leq T_A \leq +125^\circ\text{C}$			$\pm 100$	$\text{nA}$
					4	$\text{V}$
Common-Mode Rejection Ratio	CMRR	$0\text{ V} \leq V_{CM} \leq 4.0\text{ V}$ , $-40^\circ\text{C} \leq T_A \leq +125^\circ\text{C}$	0			$\text{V}$
			63	100		$\text{dB}$
Large Signal Voltage Gain	$A_{VO}$	$R_L = 2\text{ k}\Omega$ , $0.5\text{ V} < V_{OUT} < 4.5\text{ V}$		30		$\text{V/mV}$
		$R_L = 10\text{ k}\Omega$ , $0.5\text{ V} < V_{OUT} < 4.5\text{ V}$	50	100		$\text{V/mV}$
		$R_L = 10\text{ k}\Omega$ , $-40^\circ\text{C} \leq T_A \leq +125^\circ\text{C}$	30			$\text{V/mV}$
Offset Voltage Drift	$\Delta V_{OS}/\Delta T$			2		$\mu\text{V}/^\circ\text{C}$
Bias Current Drift	$\Delta I_B/\Delta T$			500		$\text{pA}/^\circ\text{C}$
<b>OUTPUT CHARACTERISTICS</b>						
Output Voltage Swing High	$V_{OH}$	$I_L = 250\text{ }\mu\text{A}$ $-40^\circ\text{C} \leq T_A \leq +125^\circ\text{C}$	4.90			$\text{V}$
			4.80			$\text{V}$
Output Voltage Swing Low	$V_{OL}$	$I_L = 5\text{ mA}$ $I_L = 250\text{ }\mu\text{A}$ $-40^\circ\text{C} \leq T_A \leq +125^\circ\text{C}$			80	$\text{mV}$
		$I_L = 5\text{ mA}$			200	$\text{mV}$
Short-Circuit Current	$I_{SC}$	Short to Ground, Instantaneous		$\pm 70$		$\text{mA}$
Maximum Output Current	$I_{OUT}$			$\pm 25$		$\text{mA}$
<b>POWER SUPPLY</b>						
Power Supply Rejection Ratio	PSRR	$V_S = 2.7\text{ V to } 7\text{ V}$ , $-40^\circ\text{C} \leq T_A \leq +125^\circ\text{C}$		110		$\text{dB}$
				80		$\text{dB}$
Supply Current/Amplifier	$I_{SY}$	$V_{OUT} = 2.5\text{ V}$ $-40^\circ\text{C} \leq T_A \leq +125^\circ\text{C}$		600	1,200	$\mu\text{A}$
					1,400	$\mu\text{A}$
<b>DYNAMIC PERFORMANCE</b>						
Slew Rate	SR	$1\text{ V} < V_{OUT} < 4\text{ V}$ , $R_L = 10\text{ k}\Omega$		2.9		$\text{V}/\mu\text{s}$
Settling Time	$t_s$	To 0.01%		1,200		$\text{ns}$
Gain Bandwidth Product	GBP			8		$\text{MHz}$
Phase Margin	$\phi_m$			60		Degrees
<b>NOISE PERFORMANCE</b>						
Voltage Noise	$e_n\text{ p-p}$	0.1 Hz to 10 Hz		0.5		$\mu\text{V p-p}$
Voltage Noise Density	$e_n$	$f = 1\text{ kHz}$		10		$\text{nV}/\sqrt{\text{Hz}}$
Current Noise Density	$i_n$	$f = 1\text{ kHz}$		0.4		$\text{pA}/\sqrt{\text{Hz}}$

Specifications subject to change without notice.

**ELECTRICAL CHARACTERISTICS** ( $V_S = 3.0\text{ V}$ ,  $V_- = 0\text{ V}$ ,  $V_{CM} = 1.5\text{ V}$ ,  $T_A = 25^\circ\text{C}$ , unless otherwise noted.)

Parameter	Symbol	Conditions	Min	Typ	Max	Unit
<b>INPUT CHARACTERISTICS</b>						
Offset Voltage	$V_{OS}$	AD8519AKS, AD8519ART $-40^\circ\text{C} \leq T_A \leq +125^\circ\text{C}$		700	1,200	$\mu\text{V}$
				900	1,400	$\mu\text{V}$
		AD8519AR (R-8), AD8529 $-40^\circ\text{C} \leq T_A \leq +125^\circ\text{C}$		700	1,100	$\mu\text{V}$
Input Bias Current	$I_B$				1,200	$\mu\text{V}$
Input Offset Current	$I_{OS}$				300	nA
Input Voltage Range	$V_{CM}$		0		2	V
Common-Mode Rejection Ratio	CMRR	$0\text{ V} \leq V_{CM} \leq 2.0\text{ V}$ , $-40^\circ\text{C} \leq T_A \leq +125^\circ\text{C}$	55	75		dB
Large Signal Voltage Gain	$A_{VO}$	$R_L = 2\text{ k}\Omega$ , $0.5\text{ V} < V_{OUT} < 2.5\text{ V}$ $R_L = 10\text{ k}\Omega$	20	20	30	V/mV
						V/mV
<b>OUTPUT CHARACTERISTICS</b>						
Output Voltage Swing High	$V_{OH}$	$I_L = 250\text{ }\mu\text{A}$	2.90			V
		$I_L = 5\text{ mA}$	2.80			V
Output Voltage Swing Low	$V_{OL}$	$I_L = 250\text{ }\mu\text{A}$			100	mV
		$I_L = 5\text{ mA}$			200	mV
<b>POWER SUPPLY</b>						
Power Supply Rejection Ratio	PSRR	$V_S = 2.5\text{ V to } 7\text{ V}$ , $-40^\circ\text{C} \leq T_A \leq +125^\circ\text{C}$	60	80		dB
Supply Current/Amplifier	$I_{SY}$	$V_{OUT} = 1.5\text{ V}$ $-40^\circ\text{C} \leq T_A \leq +125^\circ\text{C}$		600	1,100 1,300	$\mu\text{A}$ $\mu\text{A}$
<b>DYNAMIC PERFORMANCE</b>						
Slew Rate	SR	$R_L = 10\text{ k}\Omega$		1.5		V/ $\mu\text{s}$
Settling Time	$t_S$	To 0.01%		2,000		ns
Gain Bandwidth Product	GBP			6		MHz
Phase Margin	$\phi_m$			55		Degrees
<b>NOISE PERFORMANCE</b>						
Voltage Noise Density	$e_n$	$f = 1\text{ kHz}$		10		$\text{nV}/\sqrt{\text{Hz}}$
Current Noise Density	$i_n$	$f = 1\text{ kHz}$		0.4		$\text{pA}/\sqrt{\text{Hz}}$

Specifications subject to change without notice.

# AD8519/AD8529—SPECIFICATIONS

## ELECTRICAL CHARACTERISTICS ( $V_S = 2.7\text{ V}$ , $V_- = 0\text{ V}$ , $V_{CM} = 1.35\text{ V}$ , $T_A = 25^\circ\text{C}$ , unless otherwise noted.)

Parameter	Symbol	Conditions	Min	Typ	Max	Unit
<b>INPUT CHARACTERISTICS</b>						
Offset Voltage	$V_{OS}$	AD8519AKS, AD8519ART		700	1,400	$\mu\text{V}$
		$-40^\circ\text{C} \leq T_A \leq +125^\circ\text{C}$		900	1,600	$\mu\text{V}$
Input Bias Current	$I_B$	AD8519AR (R-8), AD8529		700	1,200	$\mu\text{V}$
		$-40^\circ\text{C} \leq T_A \leq +125^\circ\text{C}$			1,300	$\mu\text{V}$
Input Offset Current	$I_{OS}$				300	nA
Input Voltage Range	$V_{CM}$		0		$\pm 50$	nA
Common-Mode Rejection Ratio	CMRR	$0\text{ V} \leq V_{CM} \leq 1.7\text{ V}$ , $-40^\circ\text{C} \leq T_A \leq +125^\circ\text{C}$			2	V
Large Signal Voltage Gain	$A_{VO}$	$R_L = 2\text{ k}\Omega$ , $0.5\text{ V} < V_{OUT} < 2.2\text{ V}$	55	75		dB
		$R_L = 10\text{ k}\Omega$	20	30		V/mV
<b>OUTPUT CHARACTERISTICS</b>						
Output Voltage Swing High	$V_{OH}$	$I_L = 250\text{ }\mu\text{A}$	2.60			V
Output Voltage Swing Low	$V_{OL}$	$I_L = 5\text{ mA}$	2.50			V
		$I_L = 250\text{ }\mu\text{A}$			100	mV
		$I_L = 5\text{ mA}$			200	mV
<b>POWER SUPPLY</b>						
Power Supply Rejection Ratio	PSRR	$V_S = 2.5\text{ V to } 7\text{ V}$ , $-40^\circ\text{C} \leq T_A \leq +125^\circ\text{C}$	60	80		dB
Supply Current/Amplifier	$I_{SY}$	$V_{OUT} = 1.35\text{ V}$		600	1,100	$\mu\text{A}$
		$-40^\circ\text{C} \leq T_A \leq +125^\circ\text{C}$			1,300	$\mu\text{A}$
<b>DYNAMIC PERFORMANCE</b>						
Slew Rate	SR	$R_L = 10\text{ k}\Omega$		1.5		V/ $\mu\text{s}$
Settling Time	$t_S$	To 0.01%		2,000		ns
Gain Bandwidth Product	GBP			6		MHz
Phase Margin	$\phi_m$			55		Degrees
<b>NOISE PERFORMANCE</b>						
Voltage Noise Density	$e_n$	$f = 1\text{ kHz}$		10		$\text{nV}/\sqrt{\text{Hz}}$
Current Noise Density	$i_n$	$f = 1\text{ kHz}$		0.4		$\text{pA}/\sqrt{\text{Hz}}$

Specifications subject to change without notice.

**ELECTRICAL CHARACTERISTICS** ( $V_S = 5.0\text{ V}$ ,  $V_- = -5\text{ V}$ ,  $V_{CM} = 0\text{ V}$ ,  $T_A = 25^\circ\text{C}$ , unless otherwise noted.)

Parameter	Symbol	Conditions	Min	Typ	Max	Unit
<b>INPUT CHARACTERISTICS</b>						
Offset Voltage	$V_{OS}$	AD8519AKS, AD8519ART $-40^\circ\text{C} \leq T_A \leq +125^\circ\text{C}$		600	1,100	$\mu\text{V}$
		$-40^\circ\text{C} \leq T_A \leq +125^\circ\text{C}$		800	1,300	$\mu\text{V}$
		AD8519AR (R-8), AD8529 $-40^\circ\text{C} \leq T_A \leq +125^\circ\text{C}$		600	1,000	$\mu\text{V}$
		$-40^\circ\text{C} \leq T_A \leq +125^\circ\text{C}$			1,100	$\mu\text{V}$
Input Bias Current	$I_B$	$V_{CM} = 0\text{ V}$			300	nA
		$V_{CM} = 0\text{ V}$ , $-40^\circ\text{C} \leq T_A \leq +125^\circ\text{C}$			400	nA
Input Offset Current	$I_{OS}$	$V_{CM} = 0\text{ V}$			$\pm 50$	nA
		$V_{CM} = 0\text{ V}$ , $-40^\circ\text{C} \leq T_A \leq +125^\circ\text{C}$			$\pm 100$	nA
Input Voltage Range	$V_{CM}$		-5		+4	V
Common-Mode Rejection Ratio	CMRR	$-4.9\text{ V} \leq V_{CM} \leq +4.0\text{ V}$ , $-40^\circ\text{C} \leq T_A \leq +125^\circ\text{C}$	70	100		dB
Large Signal Voltage Gain	$A_{VO}$	$R_L = 2\text{ k}\Omega$		30		V/mV
		$R_L = 10\text{ k}\Omega$	50	200		V/mV
		$-40^\circ\text{C} \leq T_A \leq +125^\circ\text{C}$	25			V/mV
Offset Voltage Drift	$\Delta V_{OS}/\Delta T$			2		$\mu\text{V}/^\circ\text{C}$
Bias Current Drift	$\Delta I_B/\Delta T$			500		$\text{pA}/^\circ\text{C}$
<b>OUTPUT CHARACTERISTICS</b>						
Output Voltage Swing High	$V_{OH}$	$I_L = 250\text{ }\mu\text{A}$ $-40^\circ\text{C} \leq T_A \leq +125^\circ\text{C}$	4.90			V
		$I_L = 5\text{ mA}$	4.80			V
Output Voltage Swing Low	$V_{OL}$	$I_L = 250\text{ }\mu\text{A}$ $-40^\circ\text{C} \leq T_A \leq +125^\circ\text{C}$			-4.90	V
		$I_L = 5\text{ mA}$			-4.80	V
Short-Circuit Current	$I_{SC}$	Short to Ground, Instantaneous		$\pm 70$		mA
Maximum Output Current	$I_{OUT}$			$\pm 25$		mA
<b>POWER SUPPLY</b>						
Power Supply Rejection Ratio	PSRR	$V_S = \pm 1.5\text{ V to } \pm 6\text{ V}$ , $-40^\circ\text{C} \leq T_A \leq +125^\circ\text{C}$	60	100		dB
Supply Current/Amplifier	$I_{SY}$	$V_{OUT} = 0\text{ V}$ $-40^\circ\text{C} \leq T_A \leq +125^\circ\text{C}$		600	1,200	$\mu\text{A}$
					1,400	$\mu\text{A}$
<b>DYNAMIC PERFORMANCE</b>						
Slew Rate	SR	$-4\text{ V} < V_{OUT} < +4\text{ V}$ , $R_L = 10\text{ k}\Omega$		2.9		V/ $\mu\text{s}$
Settling Time	$t_s$	To 0.01%		1,000		ns
Gain Bandwidth Product	GBP			8		MHz
Phase Margin	$\phi_m$			60		Degrees
<b>NOISE PERFORMANCE</b>						
Voltage Noise Density	$e_n$	$f = 1\text{ kHz}$		10		$\text{nV}/\sqrt{\text{Hz}}$
Current Noise Density	$i_n$	$f = 1\text{ kHz}$		0.4		$\text{pA}/\sqrt{\text{Hz}}$

Specifications subject to change without notice.

# AD8519/AD8529

## ABSOLUTE MAXIMUM RATINGS<sup>1</sup>

Supply Voltage	±6 V
Input Voltage <sup>2</sup>	±6 V
Differential Input Voltage <sup>3</sup>	±0.6 V
Storage Temperature Range	−65°C to +150°C
Operating Temperature Range	−40°C to +125°C
Junction Temperature Range	−65°C to +150°C
Lead Temperature Range (Soldering, 60 sec)	300°C

### NOTES

<sup>1</sup>Stresses above those listed under Absolute Maximum Ratings may cause permanent damage to the device. This is a stress rating only; functional operation of the device at these or any other conditions above those listed in the operational sections of this specification is not implied. Exposure to absolute maximum rating conditions for extended periods may affect device reliability.

<sup>2</sup>For supply voltages less than ±6 V, the input voltage is limited to less than or equal to the supply voltage.

<sup>3</sup>For differential input voltages greater than ±0.6 V, the input current should be limited to less than 5 mA to prevent degradation or destruction of the input devices.

Package Type	$\theta_{JA}$ *	$\theta_{JC}$	Unit
5-Lead SC70 (KS)	376	126	°C/W
5-Lead SOT-23 (RT)	230	146	°C/W
8-Lead SOIC (R)	158	43	°C/W
8-Lead MSOP (RM)	210	45	°C/W

\* $\theta_{JA}$  is specified for worst-case conditions, i.e.,  $\theta_{JA}$  is specified for device soldered in circuit board for SOT-23 and SOIC packages.

## ORDERING GUIDE

Model	Temperature Range	Package Description	Package Option	Branding Information
AD8519AKS*	−40°C to +125°C	5-Lead SC70	KS-5	A3B
AD8519ART*	−40°C to +125°C	5-Lead SOT-23	RT-5	A3A
AD8519AR	−40°C to +125°C	8-Lead SOIC	R-8	
AD8529AR	−40°C to +125°C	8-Lead SOIC	R-8	
AD8529ARM*	−40°C to +125°C	8-Lead MSOP	RM-8	A5A

\*Available in reels only.

## CAUTION

ESD (electrostatic discharge) sensitive device. Electrostatic charges as high as 4000 V readily accumulate on the human body and test equipment and can discharge without detection. Although the AD8519/AD8529 feature proprietary ESD protection circuitry, permanent damage may occur on devices subjected to high energy electrostatic discharges. Therefore, proper ESD precautions are recommended to avoid performance degradation or loss of functionality.



# Typical Performance Characteristics—AD8519/AD8529

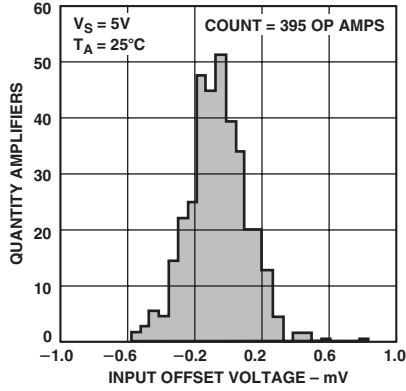

TPC 1. Input Offset Voltage Distribution

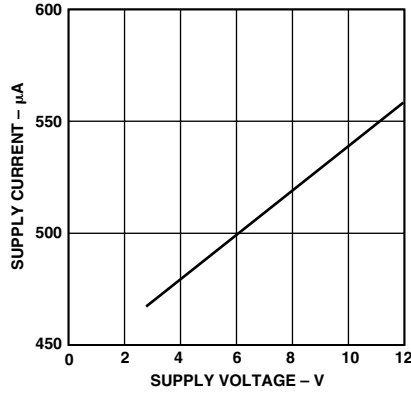

TPC 2. Supply Current per Amplifier vs. Supply Voltage

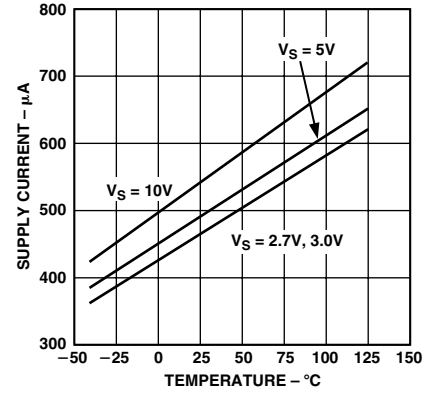

TPC 3. Supply Current per Amplifier vs. Temperature

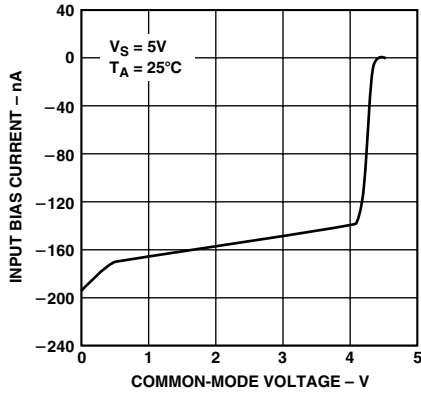

TPC 4. Input Bias Current vs. Common-Mode Voltage

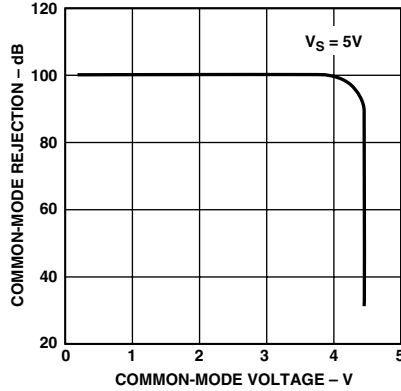

TPC 5. Common-Mode Rejection vs. Common-Mode Voltage

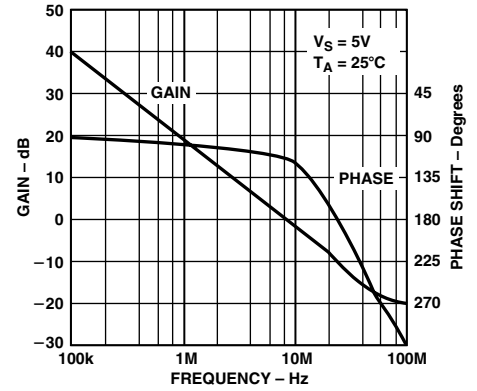

TPC 6. Open-Loop Gain, Phase vs. Frequency

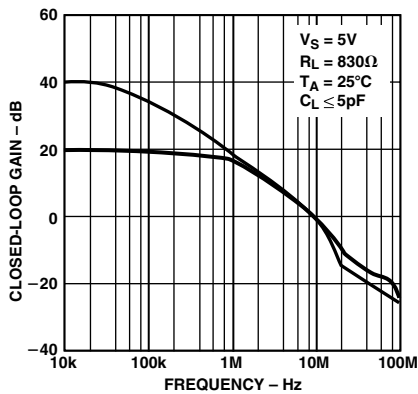

TPC 7. Closed-Loop Gain vs. Frequency

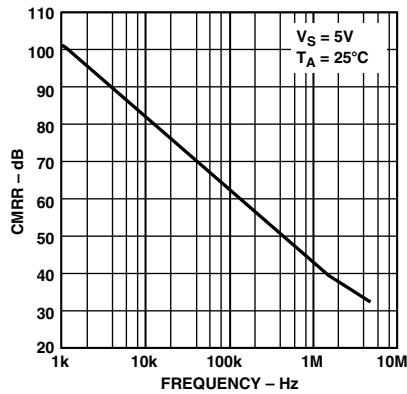

TPC 8. CMRR vs. Frequency

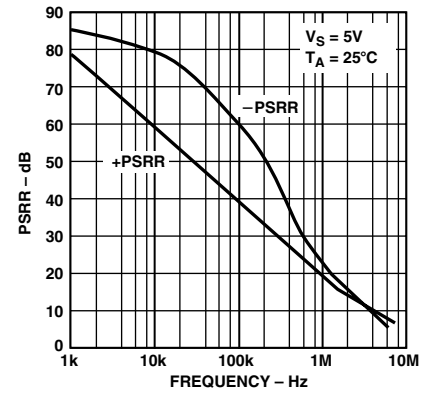

TPC 9. PSRR vs. Frequency

# AD8519/AD8529

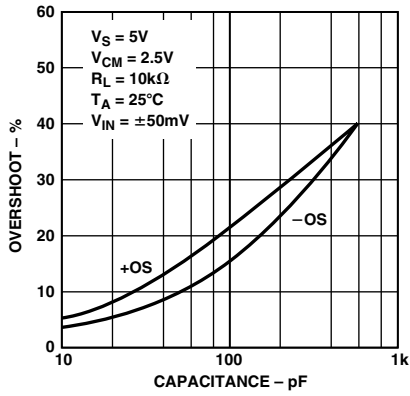

TPC 10. Overshoot vs. Capacitance Load

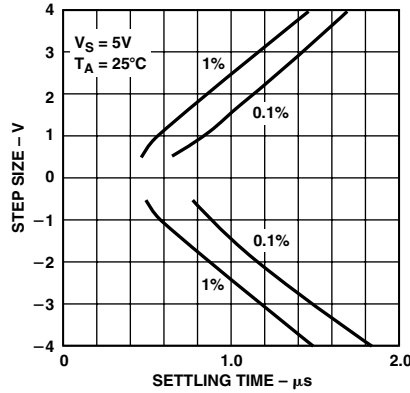

TPC 11. Step Size vs. Settling Time

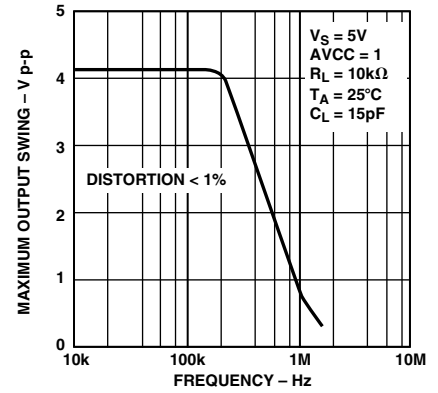

TPC 12. Output Swing vs. Frequency

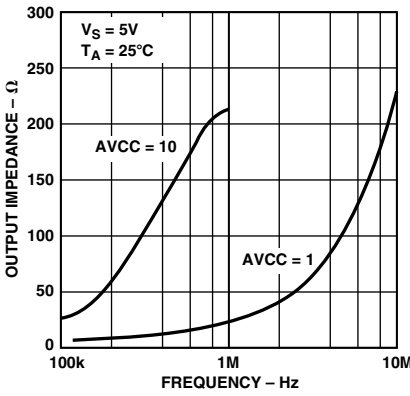

TPC 13. Output Impedance vs. Frequency

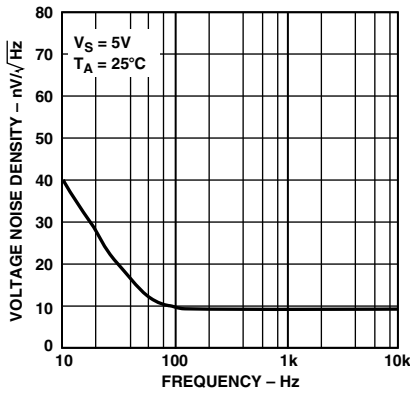

TPC 14. AD8519 Voltage Noise Density

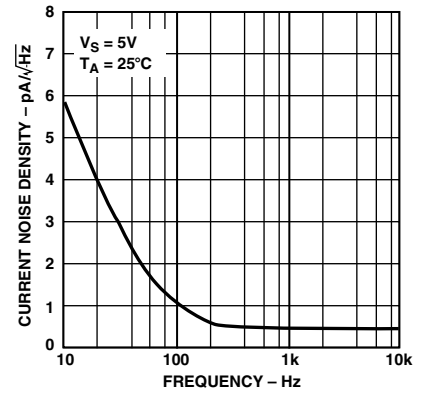

TPC 15. AD8519 Current Noise Density

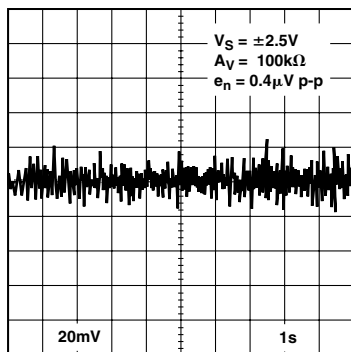

TPC 16. 0.1 Hz to 10 Hz Noise

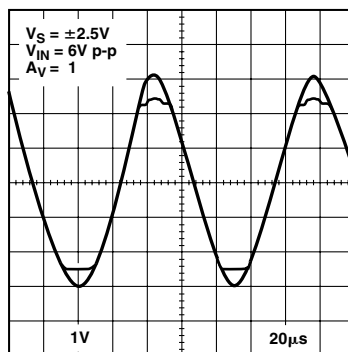

TPC 17. No Phase Reversal

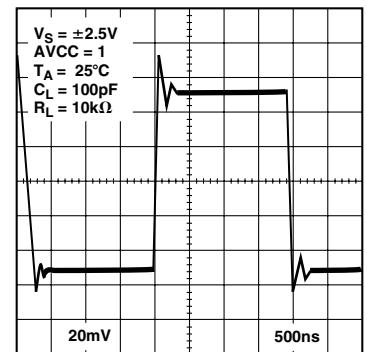

TPC 18. Small Signal Transient Response



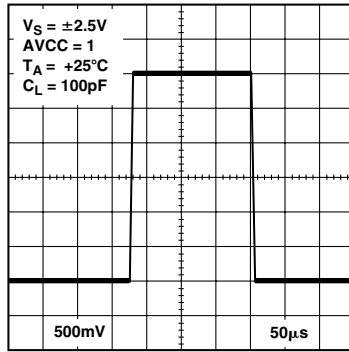

TPC 19. Large Signal Transient Response

## APPLICATIONS INFORMATION

### Maximum Power Dissipation

The maximum power that can be safely dissipated by the AD8519/AD8529 is limited by the associated rise in junction temperature. The maximum safe junction temperature is 150°C for these plastic packages. If this maximum is momentarily exceeded, proper circuit operation will be restored as soon as the die temperature is reduced. Operating the product in the “overheated” condition for an extended period can result in permanent damage to the device.

### Precision Full-Wave Rectifier

Slew rate is probably the most underestimated parameter when designing a precision rectifier. Yet without a good slew rate large glitches will be generated during the period when both diodes are off.

Let’s examine the operation of the basic circuit (shown in Figure 1) before considering slew rate further. U1 is set up to have two states of operation. D1 and D2 diodes switch the output between the two states. State one is an inverter with a gain of +1, and state two is a simple unity gain buffer where the output is equal to the value of the virtual ground. The virtual ground is the potential present at the noninverting node of the U1. State one is active when  $V_{IN}$  is larger than the virtual ground. D2 is on in this condition. If  $V_{IN}$  drops below virtual ground, D2 turns off and D1 turns on. This causes the output of U1 to simply buffer the virtual ground and this configuration is state two. So, the function of U1, which results from these two states of operation, is a half wave inverter. The U2 function takes the inverted half wave at a gain of two and sums it into the original  $V_{IN}$  wave, which outputs a rectified full wave.

$$V_{OUT} = V_{IN} - 2 \left| V_{IN}^{-1} < 0 \right|$$

This type of rectifier can be very precise if the following electrical parameters are adhered to:

1. All passive components should be of tight tolerance, 1% resistors and 5% capacitors.
2. If the application circuit requires high impedance (i.e., direct sensor interface), then a FET amplifier is probably a better choice than the AD8519.
3. An amp such as the AD8519, which has a great slew rate specification, will yield the best result because the circuit involves switching.

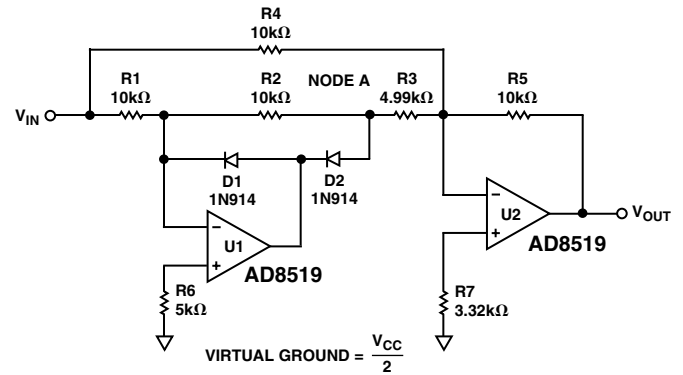

Figure 1. Precision Full-Wave Rectifier

Switching glitches are caused when D1 and D2 are both momentarily off. This condition occurs every time the input signal is equal to the virtual ground potential. When this condition occurs, the U1 stage is taken out of the  $V_{OUT}$  equation and  $V_{OUT}$  is equal to  $V_{IN} \times R5 \times (R4 \parallel R1 + R2 + R3)$ . Note that Node A should be  $V_{IN}$  inverted or virtual ground, but in this condition Node A is simply tracking  $V_{IN}$ . Given a sine wave input centered around virtual ground, glitches are generated at the sharp negative peaks of the rectified sine wave. If the glitches are hard to notice on an oscilloscope, raise the frequency of the sine wave until they become apparent. The size of the glitches is proportional to the input frequency, the diode turn-on potential (0.2 V or 0.65 V), and the slew rate of the op amp.

R6 and R7 are both necessary to limit the amount of bias current related voltage offset. Unfortunately, there is no “perfect” value for R6 because the impedance at the inverting node is altered as D1 and D2 switch. Therefore, there will also be some unresolved bias current related offset. To minimize this offset, use lower value resistors or choose a FET amplifier if the optimized offset is still intolerable.

The AD8519 offers a unique combination of speed versus power ratio at 2.7 V single supply, small size (SC70 and SOT-23), and low noise that make it an ideal choice for most high volume and high precision rectifier circuits.

### 10× Microphone Preamp Meets PC99 Specifications

This circuit, while lacking a unique topology, is anything but featureless when an AD8519 is used as the op amp. This preamp gives 20 dB gain over a frequency range of 20 Hz to 20 kHz and is fully PC99 compliant in all parameters including THD+N, dynamic range, frequency range, amplitude range, crosstalk, and so on. Not only does this preamp comply with the PC99 specifications, it far surpasses them. In fact, this preamp has a  $V_{OUT}$  noise of around 100 dB, which is suitable for most professional 20-bit audio systems. Referred to input noise is 120 dB. At 120 dB THD+N in unity gain, the AD8519 is suitable for 24-bit professional audio systems. In other words, the AD8519 will not be the limiting performance factor in audio systems despite its small size and low cost.

# AD8519/AD8529

Slew rate related distortion would not be present at the lower voltages because the AD8519 is so fast at 2.1 V/ $\mu$ s. A general rule of thumb for determining the necessary slew rate for an audio system is to take the maximum output voltage range of the device given the design's power rails and divide by two. In Figure 2, the power rails are 2.7 V and the output is rail-to-rail. Enter these numbers into the equation:  $2.7/2$  is 1.35 V and the minimum ideal slew rate is 1.35 V/ $\mu$ s.

While this data sheet gives only one audio example, many audio circuits are enhanced with the use of the AD8519. Following are a few examples: active audio filters such as bass, treble, and equalizers; PWM filters at the output of audio DACs; buffers and summers for mixing stations; and gain stages for volume control.

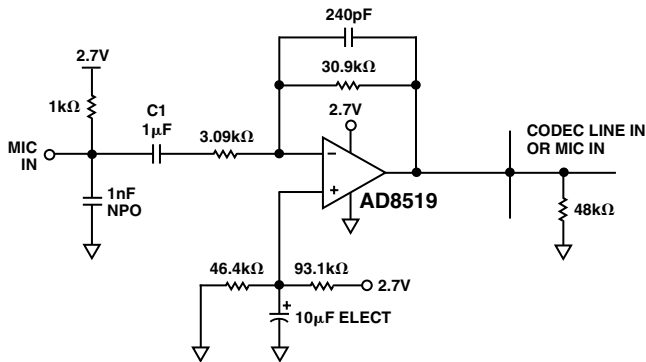

Figure 2. 10× Microphone Preamplifier

## Two-Element Varying Bridge Amplifier

There are a host of bridge configurations available to designers. For a complete analysis, look at the ubiquitous bridge and its different forms. Please refer to the 1992 Amplifier Applications Guide\*.

Figure 3 is a schematic of a two-element varying bridge. This configuration is commonly found in pressure and flow transducers. With two-elements varying, the signal will be 2× as compared to a single-element varying bridge. The advantages of this type of bridge are gain setting range, no signal input equals 0 V out, and single-supply application. Negative characteristics are nonlinear operation and required R matching. Given these sets of conditions, requirements, and characteristics, the AD8519 can be successfully used in this configuration because of its rail-to-rail output and low offset. Perhaps the greatest benefits of the AD8519, when used in the bridge configuration, are the advantages it can bring when placed in a remote bridge sensor. For example, the tiny SC70 and SOT-23 packages will reduce the overall sensor size; low power allows for remote powering via batteries or solar cells, high output current drive to drive a long cable, and 2.7 V operation for two-cell operation.

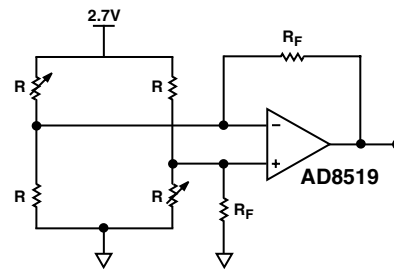

Figure 3. Two-Element Varying Bridge Amplifier

\*Adolfo Garcia and James Wong, Chapter 2, 1992 Amplifier Applications Guide.

```

* AD8519/AD8529 SPICE Macro-model
* 10/98, Ver. 1
* TAM / ADSC
*
* Copyright 1998 by Analog Devices
*
* Refer to "README.DOC" file for License State-
* ment. Use of this model
* indicates your acceptance of the terms and
* provisions in the License
* Statement.
*
* Node Assignments
*
*                               noninverting input
*                               |
*                               |   inverting input
*                               |   |
*                               |   |   positive supply
*                               |   |   |
*                               |   |   |   negative supply
*                               |   |   |   |
*                               |   |   |   |   output
*                               |   |   |   |   |
*                               |   |   |   |   |
*
.SUBCKT AD8519    1    2    99    50    45
*
*INPUT STAGE
*
Q1 5 7 15 PIX
Q2 6 2 15 PIX
IOS 1 2 1.25E-9
I1 99 15 200E-6
EOS 7 1 POLY(2) (14,98) (73,98) 1E-3 1 1
RC1 5 50 2E3
RC2 6 50 2E3
C1 5 6 1.3E-12
D1 15 8 DX
V1 99 8 DC 0.9
*
* INTERNAL VOLTAGE REFERENCE
*
EREF 98 0 POLY(2) (99,0) (50,0) 0 .5 .5
ISY 99 50 300E-6
*
* CMRR=100dB, ZERO AT 1kHz
*
ECM 13 98 POLY(2) (1,98) (2,98) 0 0.5 0.5
RCM1 13 14 1E6
RCM2 14 98 10
CCM1 13 14 240E-12
*
* PSRR=100dB, ZERO AT 200Hz
*
RPS1 70 0 1E6
RPS2 71 0 1E6
CPS1 99 70 1E-5
CPS2 50 71 1E-5
EPSY 98 72 POLY(2) (70,0) (0,71) 0 1 1
RPS3 72 73 1.59E6
CPS3 72 73 500E-12
RPS4 73 98 15.9
*
* POLE AT 20MHZ, ZERO AT 60MHZ
*
G1 21 98 (5,6) 5.88E-6
R1 21 98 170E3
R2 21 22 85E3
C2 22 98 40E-15
*
* GAIN STAGE
*
G2 25 98 (21,98) 37.5E-6
R5 25 98 1E7
CF 45 25 5E-12
D3 25 99 DX
D4 50 25 DX
*
* OUTPUT STAGE
*
Q3 45 41 99 POUT
Q4 45 43 50 NOUT
EB1 99 40 POLY(1) (98,25) 0.594 1
EB2 42 50 POLY(1) (25,98) 0.594 1
RB1 40 41 500
RB2 42 43 500
*
* MODELS
*
.MODEL PIX PNP (BF=500,IS=1E-14,KF=5E-6)
.MODEL POUT PNP (BF=100,IS=1E-14,BR=0.517)
.MODEL NOUT NPN (BF=100,IS=1E-14,BR=0.413)
.MODEL DX D(IS=1E-14,CJO=1E-15)
.ENDS AD8519

```

# AD8519/AD8529

## OUTLINE DIMENSIONS

### 8-Lead Standard Small Outline Package [SOIC] Narrow Body (R-8)

Dimensions shown in millimeters and (inches)

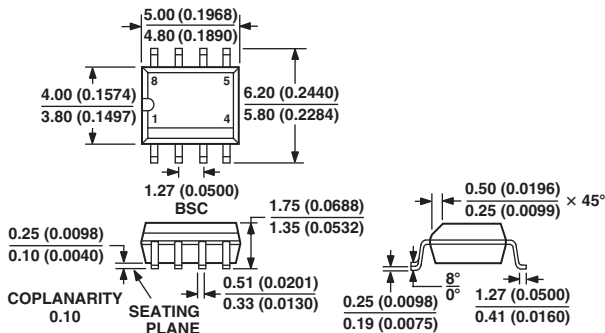

COMPLIANT TO JEDEC STANDARDS MS-012AA  
CONTROLLING DIMENSIONS ARE IN MILLIMETERS; INCH DIMENSIONS (IN PARENTHESES) ARE ROUNDED-OFF MILLIMETER EQUIVALENTS FOR REFERENCE ONLY AND ARE NOT APPROPRIATE FOR USE IN DESIGN

### 8-Lead Mini Small Outline Package [MSOP] (RM-8)

Dimensions shown in millimeters

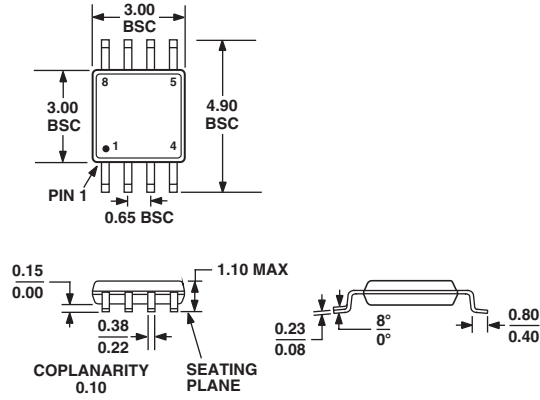

COMPLIANT TO JEDEC STANDARDS MO-187AA

### 5-Lead Plastic Surface Mount Package [SC70] (KS-5)

Dimensions shown in millimeters

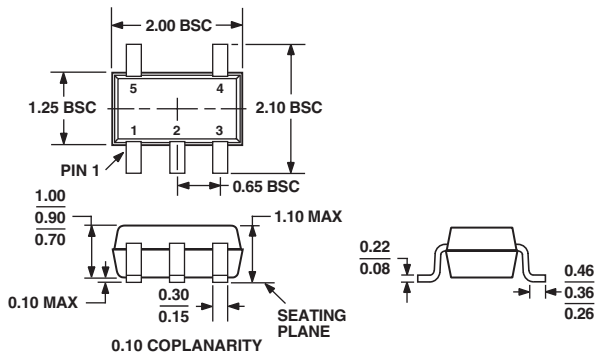

COMPLIANT TO JEDEC STANDARDS MO-203AA

### 5-Lead Plastic Surface Mount Package [SOT-23] (RT-5)

Dimensions shown in millimeters

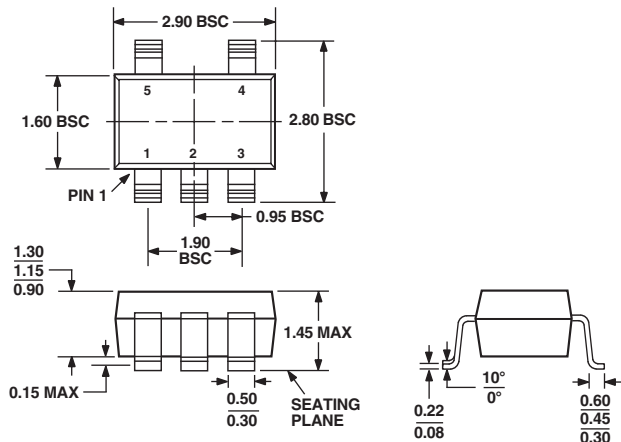

COMPLIANT TO JEDEC STANDARDS MO-178AA

## Revision History

Location

Page

2/03—Data Sheet changed from REV. B to REV. C.

Changed $\mu$ SOIC to MSOP .....	Universal
Changed SO-8 to R-8 .....	Universal
Changes to Precision Full-Wave Rectifier section .....	9
Changes to 10 $\times$ Microphone Preamp Meets PC99 Specifications section .....	9
Updated OUTLINE DIMENSIONS .....	12

This datasheet has been download from:

[www.datasheetcatalog.com](http://www.datasheetcatalog.com)

Datasheets for electronics components.