

Power MOSFETs

Q-Class

IXTH 28N50Q
IXTT 28N50Q

$V_{DSS} = 500 \text{ V}$
 $I_{D25} = 28 \text{ A}$
 $R_{DS(on)} = 0.20 \Omega$

N-Channel Enhancement Mode
Avalanche Rated, Low Q_g , High dv/dt



Symbol	Test Conditions	Maximum Ratings	
V_{DSS}	$T_J = 25^\circ\text{C}$ to 150°C	500	V
V_{DGR}	$T_J = 25^\circ\text{C}$ to 150°C ; $R_{GS} = 1 \text{ M}\Omega$	500	V
V_{GS}	Continuous	± 30	V
V_{GSM}	Transient	± 40	V
I_{D25}	$T_C = 25^\circ\text{C}$	28	A
I_{DM}	$T_C = 25^\circ\text{C}$, pulse width limited by T_{JM}	112	A
I_{AR}	$T_C = 25^\circ\text{C}$	28	A
E_{AR}	$T_C = 25^\circ\text{C}$	40	mJ
E_{AS}		1.5	J
dv/dt	$I_S \leq I_{DM}$, $di/dt \leq 100 \text{ A}/\mu\text{s}$, $V_{DD} \leq V_{DSS}$, $T_J \leq 150^\circ\text{C}$, $R_G = 2 \Omega$	10	V/ns
P_D	$T_C = 25^\circ\text{C}$	400	W
T_J		-55 to +150	$^\circ\text{C}$
T_{JM}		150	$^\circ\text{C}$
T_{stg}		-55 to +150	$^\circ\text{C}$
T_L	1.6 mm (0.063 in) from case for 10 s	300	$^\circ\text{C}$
M_d	Mounting torque	1.13/10	Nm/lb.in.
Weight	TO-247	6	g
	TO-268	4	g

TO-247 AD (IXTH)

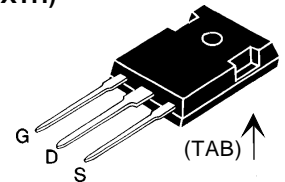

TO-268 (D3) (IXTT)

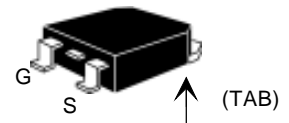

G = Gate D = Drain
S = Source TAB = Drain

Features

- IXYS advanced low Q_g process
- Low gate charge and capacitances
 - easier to drive
 - faster switching
- International standard packages
- Low $R_{DS(on)}$
- Rated for unclamped Inductive load switching (UIS) rated
- Molding epoxies meet UL 94 V-0 flammability classification

Advantages

- Easy to mount
- Space savings
- High power density

Symbol	Test Conditions	Characteristic Values ($T_J = 25^\circ\text{C}$, unless otherwise specified)		
		min.	typ.	max.
V_{DSS}	$V_{GS} = 0 \text{ V}$, $I_D = 250 \mu\text{A}$	500		V
$V_{GS(th)}$	$V_{DS} = V_{GS}$, $I_D = 250 \mu\text{A}$	2.5		V
I_{GSS}	$V_{GS} = \pm 30 \text{ V}_{DC}$, $V_{DS} = 0$			$\pm 100 \text{ nA}$
I_{DSS}	$V_{DS} = V_{DSS}$ $V_{GS} = 0 \text{ V}$	$T_J = 25^\circ\text{C}$		25 μA
		$T_J = 125^\circ\text{C}$		1 mA
$R_{DS(on)}$	$V_{GS} = 10 \text{ V}$, $I_D = 0.5 I_{D25}$ Pulse test, $t \leq 300 \mu\text{s}$, duty cycle $d \leq 2\%$			0.20 Ω

Symbol	Test Conditions	Characteristic Values ($T_J = 25^\circ\text{C}$, unless otherwise specified)		
		min.	typ.	max.
g_{fs}	$V_{DS} = 20\text{ V}; I_D = 0.5 \cdot I_{D25}$, pulse test	16	28	S
C_{iss}	$V_{GS} = 0\text{ V}, V_{DS} = 25\text{ V}, f = 1\text{ MHz}$		3300	pF
C_{oss}			480	pF
C_{rss}			125	pF
$t_{d(on)}$	$V_{GS} = 10\text{ V}, V_{DS} = 0.5 \cdot V_{DSS}, I_D = 0.5 \cdot I_{D25}$ $R_G = 2.0\ \Omega$ (External),		17	ns
t_r			20	ns
$t_{d(off)}$			51	ns
t_f			12	ns
$Q_{g(on)}$	$V_{GS} = 10\text{ V}, V_{DS} = 0.5 \cdot V_{DSS}, I_D = 0.5 \cdot I_{D25}$		94	nC
Q_{gs}			20	nC
Q_{gd}			42	nC
R_{thJC}	(TO-247)			0.31 K/W
R_{thCK}			0.25	K/W

Symbol	Test Conditions	Characteristic Values ($T_J = 25^\circ\text{C}$, unless otherwise specified)		
		min.	typ.	max.
I_S	$V_{GS} = 0\text{ V}$		28	A
I_{SM}	Repetitive; pulse width limited by T_{JM}		112	A
V_{SD}	$I_F = I_S, V_{GS} = 0\text{ V}$, Pulse test, $t \leq 300\ \mu\text{s}$, duty cycle $d \leq 2\%$		1.5	V
t_{rr}	$I_F = I_S, -di/dt = 100\text{ A}/\mu\text{s}, V_R = 100\text{ V}$		500	ns
Q_{RM}			8.0	μC

TO-247 AD (IXFH) Outline

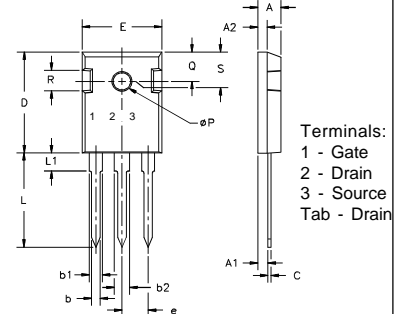

Dim.	Millimeter		Inches	
	Min.	Max.	Min.	Max.
A	4.7	5.3	.185	.209
A ₁	2.2	2.54	.087	.102
A ₂	2.2	2.6	.059	.098
b	1.0	1.4	.040	.055
b ₁	1.65	2.13	.065	.084
b ₂	2.87	3.12	.113	.123
C	.4	.8	.016	.031
D	20.80	21.46	.819	.845
E	15.75	16.26	.610	.640
e	5.20	5.72	0.205	0.225
L	19.81	20.32	.780	.800
L1		4.50		.177
∅P	3.55	3.65	.140	.144
Q	5.89	6.40	0.232	0.252
R	4.32	5.49	.170	.216
S	6.15	BSC	.242	BSC

TO-268 Outline

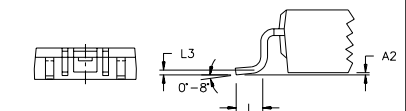
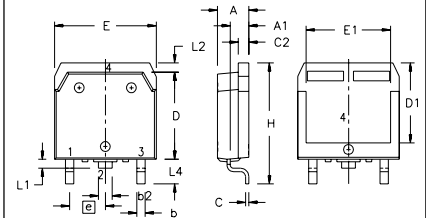

Terminals: 1 - Gate 2 - Drain
3 - Source Tab - Drain

SYM	INCHES		MILLIMETERS	
	MIN	MAX	MIN	MAX
A	.193	.201	4.90	5.10
A1	.106	.114	2.70	2.90
A2	.001	.010	0.02	0.25
b	.045	.057	1.15	1.45
b2	.075	.083	1.90	2.10
C	.016	.026	0.40	0.65
C2	.057	.063	1.45	1.60
D	.543	.551	13.80	14.00
D1	.488	.500	12.40	12.70
E	.624	.632	15.85	16.05
E1	.524	.535	13.30	13.60
e		.215 BSC		5.45 BSC
H	.736	.752	18.70	19.10
L	.094	.106	2.40	2.70
L1	.047	.055	1.20	1.40
L2	.039	.045	1.00	1.15
L3	.010	BSC	0.25	BSC
L4	.150	.161	3.80	4.10

IXYS reserves the right to change limits, test conditions, and dimensions.

Fig. 1. Output Characteristics
@ 25 Deg. C

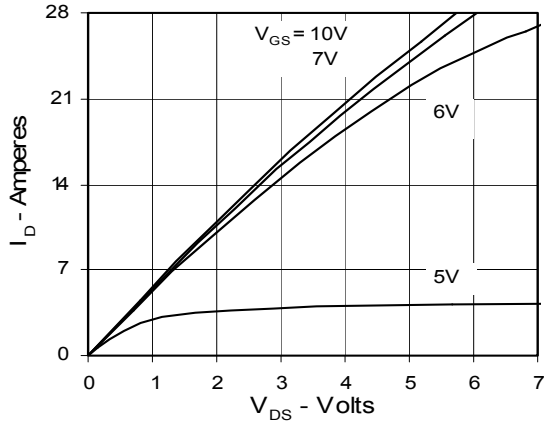

Fig. 2. Extended Output Characteristics
@ 25 deg. C

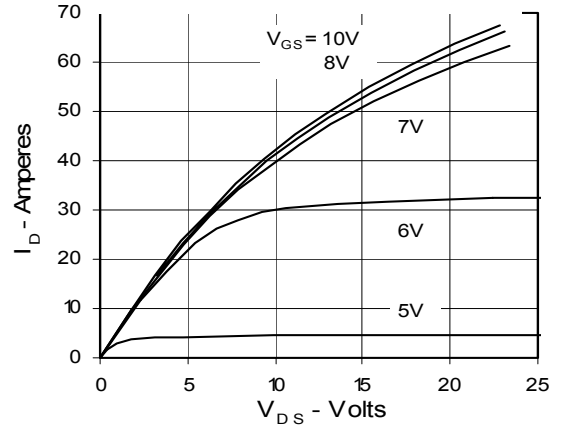

Fig. 3. Output Characteristics
@ 125 Deg. C

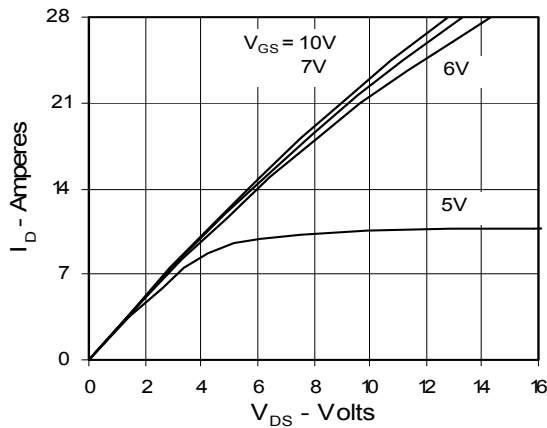

Fig. 4. $R_{DS(on)}$ Normalized to I_{D25} Value vs. Junction Temperature

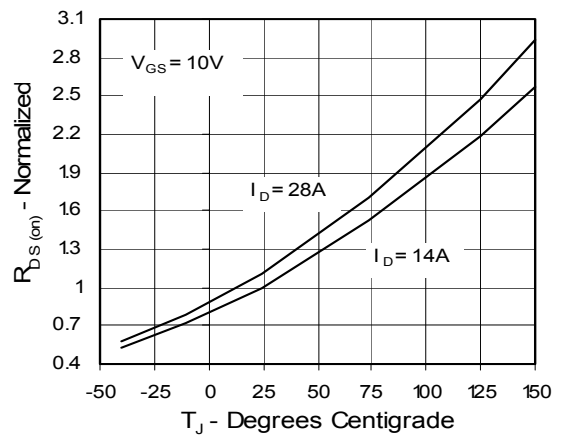

Fig. 5. $R_{DS(on)}$ Normalized to I_{D25} Value vs. I_D

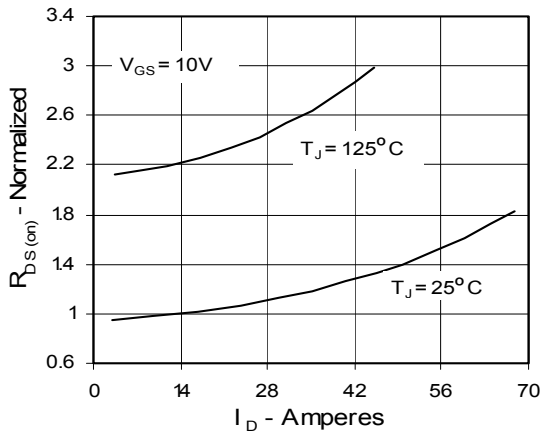

Fig. 6. Drain Current vs. Case Temperature

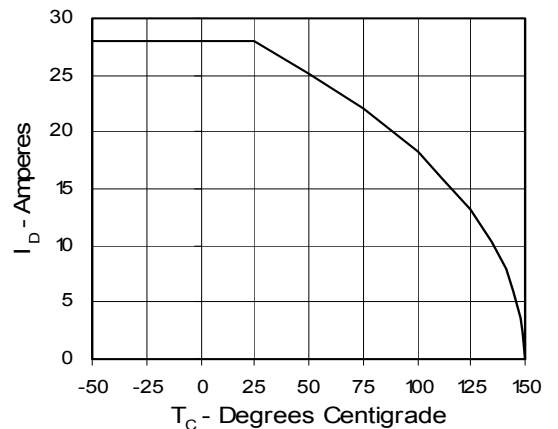

Fig. 7. Input Admittance

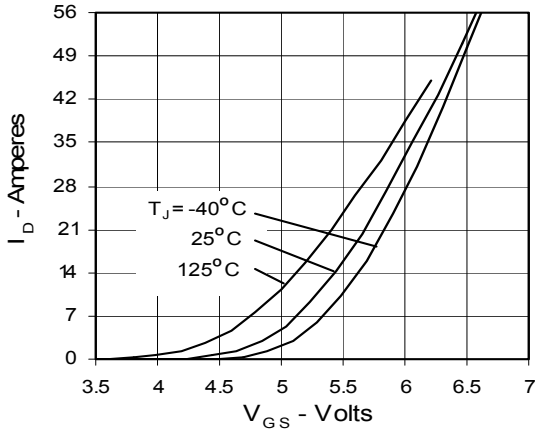

Fig. 8. Transconductance

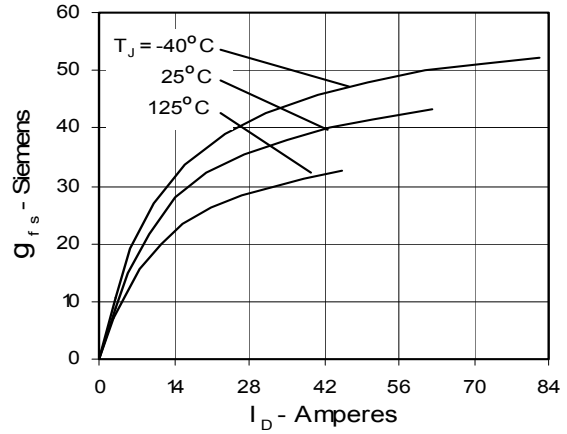

Fig. 9. Source Current vs. Source-To-Drain Voltage

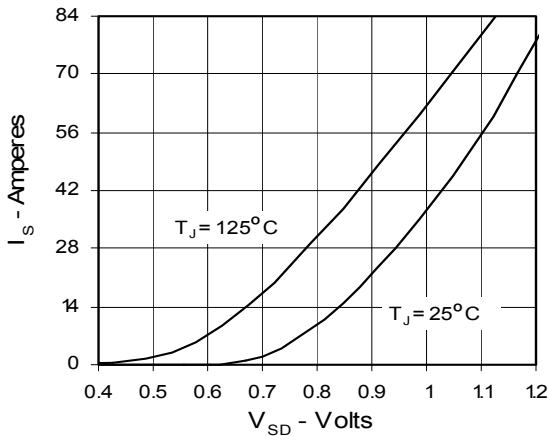

Fig. 10. Gate Charge

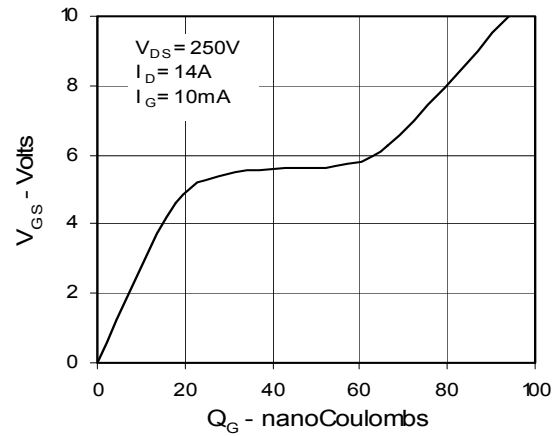

Fig. 11. Capacitance

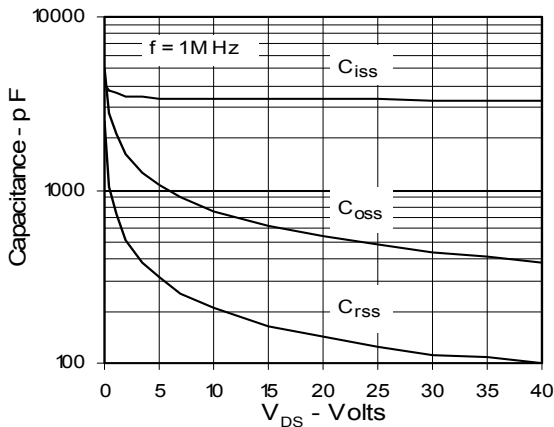
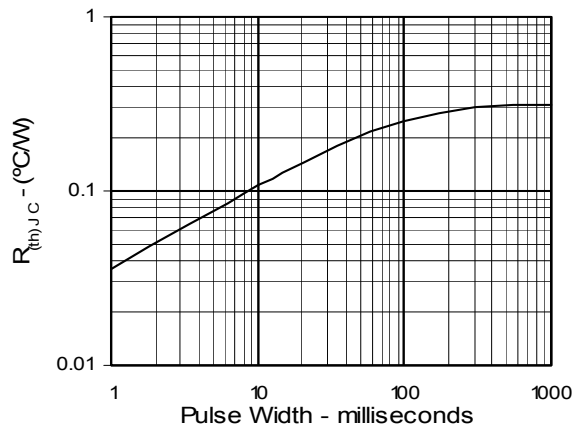

Fig. 12. Maximum Transient Thermal Resistance



IXYS reserves the right to change limits, test conditions, and dimensions.

IXYS MOSFETs and IGBTs are covered by one or more of the following U.S. patents:

4,835,592 4,881,106 5,017,508 5,049,961 5,187,117 5,486,715 6,306,728B1 6,259,123B1 6,306,728B1
4,850,072 4,931,844 5,034,796 5,063,307 5,237,481 5,381,025 6,404,065B1 6,162,665 6,534,343