

STEERING DIODE (RAIL CLAMP) ARRAY
APPLICATIONS

- High Frequency Data Lines
- RS-232 & RS-422 Interface Networks
- 10 Base T Networks
- LAN/ WAN
- Computer I/O Ports

FEATURES

- IEC 1000-4-2, -4 & -5 Industry Requirements
- Designed for Rail Clamp Protection
- ESD Protection > 40 kilovolts
- Working Voltage > 50 Volts
- UL 94V-0 Flammability Classification
- Available in Standard SO-14 Surface Mount Package

DESCRIPTION

This series is designed with discrete diodes for complete isolation. Each diode can be individually tested according to the electrical characteristics. For transient voltage protection, two diodes are configured in series with the anode of one connect to the cathode of the other diode (See Rail Clamp Circuit).

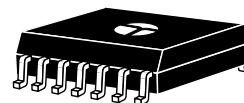
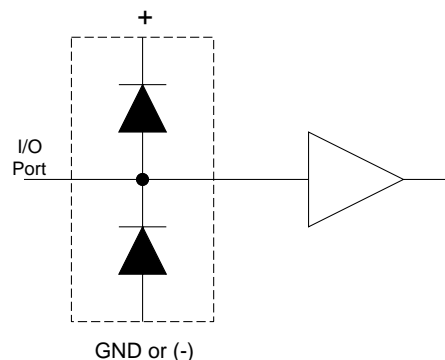
IEC 1000-4 COMPATIBLE

SO-14 PACKAGE
RAIL CLAMP CIRCUIT

SEE DIAGRAMS ON FOLLOWING PAGE.

MAXIMUM RATINGS @ 25°C Ambient Temperature (unless specified)	
Continuous Power Dissipation	500mW
Operating & Storage Temperature	-65° to +150°C
Continuous Forward Current	400mA
MECHANICAL CHARACTERISTICS	
Package	Molded SO-14 Surface Mount Package
Packaging	Tube or 16mm Tape per EIA 481
Approximate Weight	0.15 grams
Device Markings	Logo & Part Number
Miscellaneous	Pin No. 1 Indicated by Dot on Top of Package

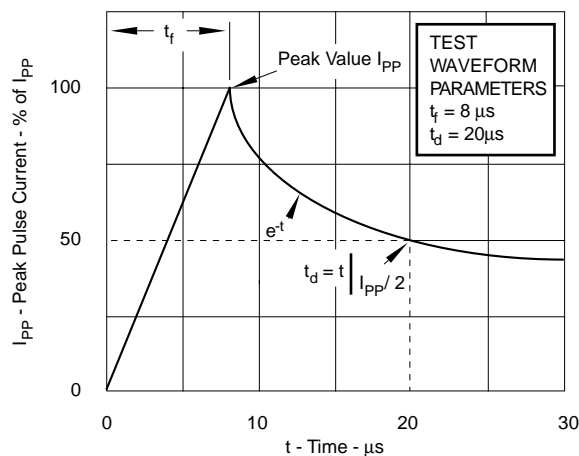
**FIGURE 1
PULSE WAVE FORM**



ELECTRICAL CHARACTERISTICS @ 25° C Ambient Temperature

PROTEK PART NUMBER	REPETITIVE PEAK REVERSE VOLTAGE @ 10 μ A $V_{PRP \text{ Min}}$ VOLTS	REVERSE LEAKAGE CURRENT @ 40 V I_{RM} μ A	MAXIMUM FORWARD VOLTAGE @ 100 mA V_F VOLTS	FORWARD PEAK PULSE CURRENT (See Fig. 1) @ 8/20 μ s I_{PP} AMPS	MAXIMUM CAPACITANCE @ 4 V, 1 MHz C pF
See Note 1	50	0.1	1.2	40	25

Note 1: Device Types Include: PMMAD130, PMMAD1103, PMMAD1105, PMMAD1106, PMMAD1107 and PMMAD1109. Electrical characteristics applies to all device types.

CIRCUIT DIAGRAM

PMMAD130

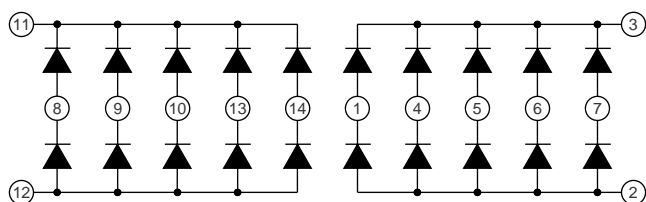

DUAL 10 DIODE ARRAY

PMMAD1106

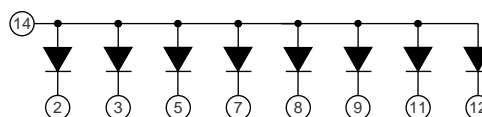

8 DIODE COMMON ANODE ARRAY
NC Pin 1, 4, 6, 10 & 13

PMMAD1103

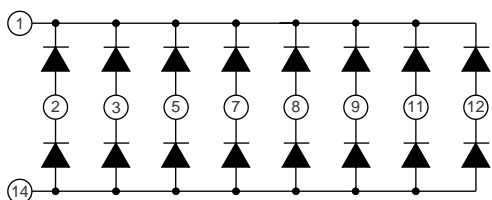

16 DIODE ARRAY
NC Pins 4, 6, 10 & 13

PMMAD1107

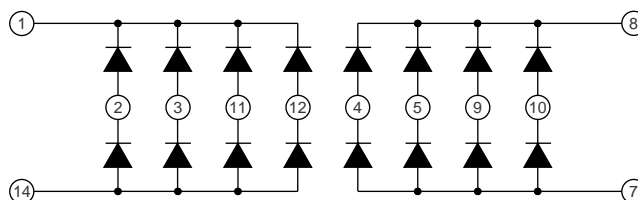

DUAL 8 DIODE ARRAY
NC Pins 6 & 13

PMMAD1105

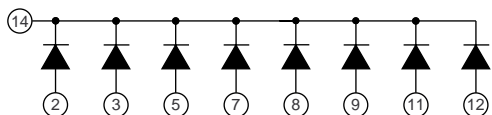

8 DIODE COMMON CATHODE ARRAY
NC Pins 1, 4, 6, 10 & 13

PMMAD1109

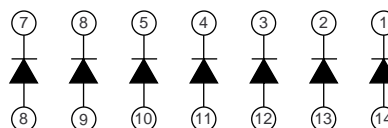

7 ISOLATED DIODE ARRAY
(Independent)



STEERING DIODE (RAIL CLAMP) ARRAY

ELECTRICAL CHARACTERISTICS @ 25° C Ambient Temperature					
PROTEK PART NUMBER	REPETITIVE PEAK REVERSE VOLTAGE @ 10 μ A $V_{PRP \text{ Min}}$ VOLTS	REVERSE LEAKAGE CURRENT @ 40 V I_{RM} μ A	FORWARD PEAK PULSE CURRENT (See Fig. 1) @ 8/20 μ s I_{PP} AMPS	MAXIMUM FORWARD VOLTAGE @ 100 mA V_F VOLTS	MAXIMUM CAPACITANCE @ 4 V, 1 MHz C pF
PMMAD1108	50	0.1	40	1.2	25

APPLICATIONS

- High Frequency Data Lines
- RS-232 & RS-422 Interface Networks
- 10 Base T Networks
- LAN/ WAN
- Computer I/O Ports

FEATURES

- IEC 1000-4-2, -4 & -5 Industry Requirements
- Eight (8) Individual Steering Diodes
- Designed for Rail Clamp Protection
- ESD Protection > 40 kilovolts
- Working Voltage > 50 Volts
- UL 94V-0 Flammability Classification
- Available in Standard SO-14 Surface Mount Package

DESCRIPTION

This device is designed with discrete diodes for complete isolation. Each diode can be individually tested according to the electrical characteristics. For transient voltage protection, two diodes are configured in series with the anode of one connect to the cathode of the other diode (See Rail Clamp Circuit).

MAXIMUM RATINGS	
Continuous Power Dissipation	500mW
Operating & Storage Temperature	-65° to +150°C
Continuous Forward Current	400mA
MECHANICAL CHARACTERISTICS	
Package	Molded SO-16 Surface Mount Package
Packaging	Tube or 16mm Tape per EIA 481
Approximate Weight	0.15 grams
Device Markings	Logo & Part Number
Miscellaneous	Pin No. 1 Indicated by Dot on Top of Package

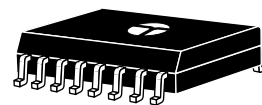
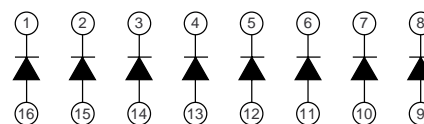
IEC 1000-4 COMPATIBLE

SO-16 PACKAGE
CIRCUIT DIAGRAM

PMMAD1108
8 ISOLATED DIODE ARRAY

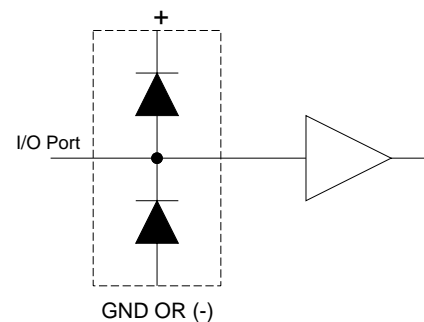
RAIL CLAMP CIRCUIT

FIGURE 1
PULSE WAVE FORM

