



STGE200NB60S

N-CHANNEL 150A - 600V - ISOTOP

PowerMESH™ IGBT

TYPE	V _{CES}	V _{CE(sat)} (typ.)	I _C	T _C
STGE200NB60S	600 V	1.2 V 1.3 V	150 A 200 A	100°C 25°C

- HIGH INPUT IMPEDANCE (VOLTAGE DRIVEN)
- LOW ON-VOLTAGE DROP (V_{cesat})
- OFF LOSSES INCLUDE TAIL CURRENT
- LOW GATE CHARGE
- HIGH CURRENT CAPABILITY

DESCRIPTION

Using the latest high voltage technology based on a patented strip layout, STMicroelectronics has designed an advanced family of IGBTs, the PowerMESH™ IGBTs, with outstanding performances. The suffix "S" identifies a family optimized to achieve very low V_{CE(sat)} (@ max frequency of 1KHz).

APPLICATIONS

- LOW FREQUENCY MOTOR CONTROLS
- ALUMINUM WELDING EQUIPMENT

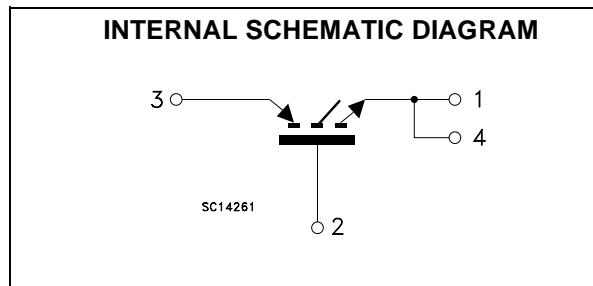
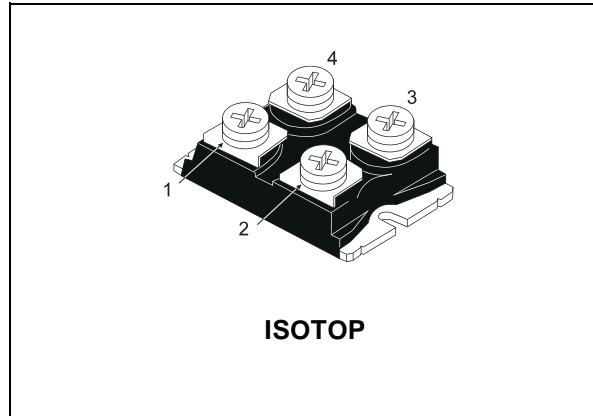

ABSOLUTE MAXIMUM RATINGS

Symbol	Parameter	Value	Unit
V _{CES}	Collector-Emitter Voltage (V _{GS} = 0)	600	V
V _{GE}	Gate-Emitter Voltage	±20	V
I _C	Collector Current (continuous) at T _C = 25°C	200	A
I _C	Collector Current (continuous) at T _C = 100°C	150	A
I _{CM} (■)	Collector Current (pulsed)	400	A
P _{TOT}	Total Dissipation at T _C = 25°C	600	W
	Derating Factor	4.8	W/°C
T _{stg}	Storage Temperature	- 65 to 150	°C
T _j	Max. Operating Junction Temperature	150	°C

(■) PULSE WIDTH LIMITED BY SAFE OPERATING AREA

STGE200NB60S

THERMAL DATA

Rthj-case	Thermal Resistance Junction-case Max	0.208	°C/W
Rthj-amb	Thermal Resistance Junction-ambient Max	30	°C/W

ELECTRICAL CHARACTERISTICS (T_{CASE} = 25 °C UNLESS OTHERWISE SPECIFIED)

OFF

Symbol	Parameter	Test Conditions	Min.	Typ.	Max.	Unit
V _{BR(CES)}	Collector-Emitter Breakdown Voltage	I _C = 250 μA, V _{GE} = 0	600			V
I _{CES}	Collector cut-off (V _{GE} = 0)	V _{CE} = Max Rating, T _C = 25 °C V _{CE} = Max Rating, T _C = 125 °C			500 5	μA mA
I _{GES}	Gate-Emitter Leakage Current (V _{CE} = 0)	V _{GE} = ±20V, V _{CE} = 0			±100	nA

ON (1)

Symbol	Parameter	Test Conditions	Min.	Typ.	Max.	Unit
V _{GE(th)}	Gate Threshold Voltage	V _{CE} = V _{GE} , I _C = 250μA	3		5	V
V _{CE(sat)}	Collector-Emitter Saturation Voltage	V _{GE} = 15V, I _C = 100 A V _{GE} = 15V, I _C =150 A, T _J =100°C		1.2 1.2	1.6	V V

DYNAMIC

Symbol	Parameter	Test Conditions	Min.	Typ.	Max.	Unit
g _{fs}	Forward Transconductance	V _{CE} = 15 V, I _C = 100 A		80		S
C _{ies} C _{oes} C _{res}	Input Capacitance Output Capacitance Reverse Transfer Capacitance	V _{CE} = 25V, f = 1 MHz, V _{GE} = 0		15600 1100 95		pF pF pF
Q _g Q _{ge} Q _{gc}	Total Gate Charge Gate-Emitter Charge Gate-Collector Charge	V _{CE} = 480V, I _C = 100 A, V _{GE} = 15V		560 70 170		nC nC nC
I _{CL}	Latching Current	V _{clamp} = 480 V T _J = 125°C, R _G = 10 Ω	300			A

SWITCHING ON

Symbol	Parameter	Test Conditions	Min.	Typ.	Max.	Unit
t _{d(on)} t _r	Turn-on Delay Time Rise Time	V _{CC} = 480 V, I _C = 100 A R _G = 2Ω, V _{GE} = 15 V		64 112		μs μs
(di/dt) _{on} E _{on}	Turn-on Current Slope Turn-on Switching Losses	V _{CC} = 480 V, I _C = 100 A R _G =2Ω V _{GE} = 15 V, T _J = 125°C		1800 12		A/μs mJ

ELECTRICAL CHARACTERISTICS (CONTINUED)

SWITCHING OFF

Symbol	Parameter	Test Conditions	Min.	Typ.	Max.	Unit
t_c	Cross-over Time	$V_{CC} = 480 \text{ V}$, $I_C = 100 \text{ A}$, $R_{GE} = 2 \Omega$, $V_{GE} = 15 \text{ V}$		2.98		μs
$t_r(V_{off})$	Off Voltage Rise Time			1.7		μs
$t_d(off)$	Delay Time			2.4		μs
t_f	Fall Time			1.23		μs
$E_{off(**)}$	Turn-off Switching Loss			59		mJ
E_{ts}	Total Switching Loss			71		mJ
t_c	Cross-over Time	$V_{CC} = 480 \text{ V}$, $I_C = 100 \text{ A}$, $R_{GE} = 2 \Omega$, $V_{GE} = 15 \text{ V}$, $T_J = 125 \text{ }^\circ\text{C}$		4.52		μs
$t_r(V_{off})$	Off Voltage Rise Time			2.6		μs
$t_d(off)$	Delay Time			2.8		μs
t_f	Fall Time			1.8		μs
$E_{off(**)}$	Turn-off Switching Loss			92		mJ
E_{ts}	Total Switching Loss			105		mJ

Note: 1. Pulsed: Pulse duration = 300 μs , duty cycle 1.5 %.
 2. Pulse width limited by max. junction temperature.
 (**)Losses include Also the Tail (Jedec Standardization)

Thermal Impedance

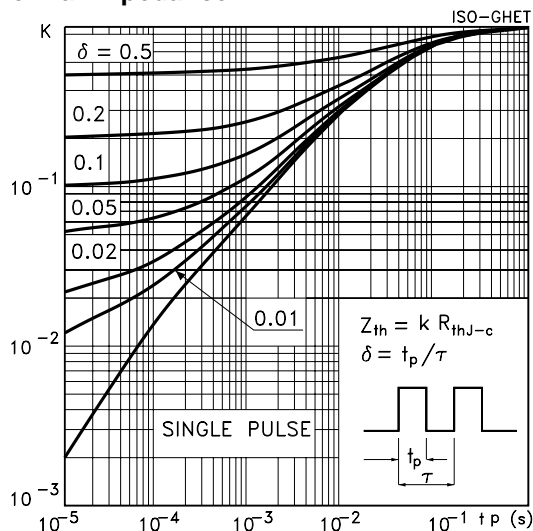

Switching Off Safe Operating Area

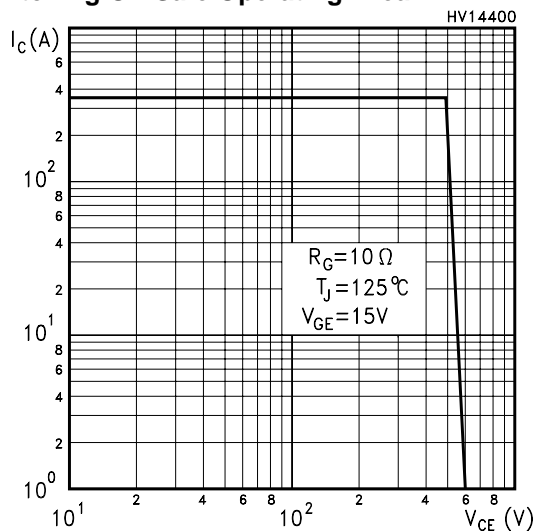

Output Characteristics

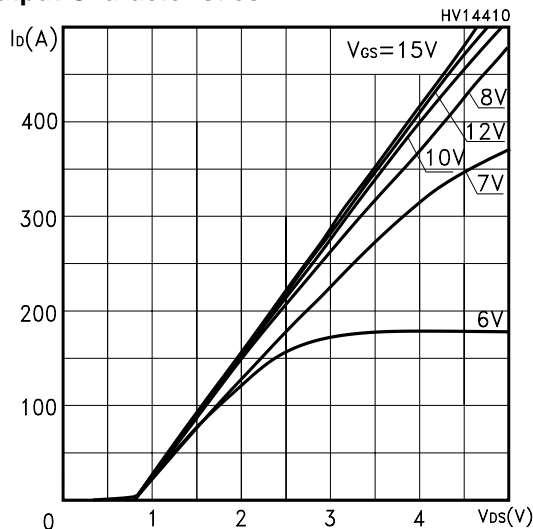

Transfer Characteristics

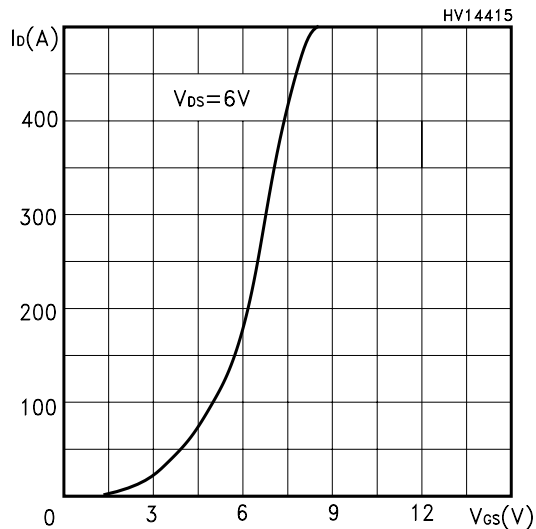

Normalized Gate Threshold Voltage vs Temp.

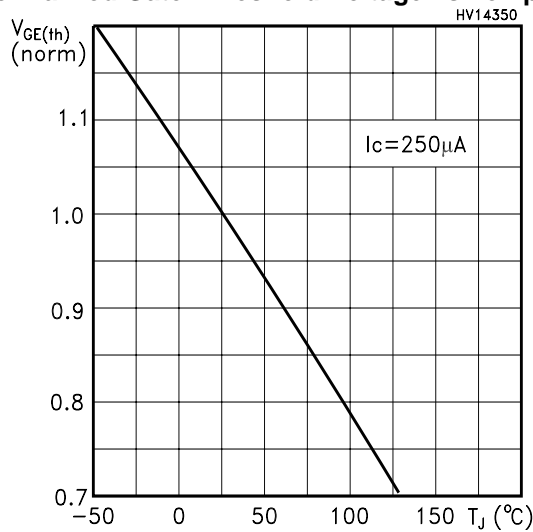

Transconductance

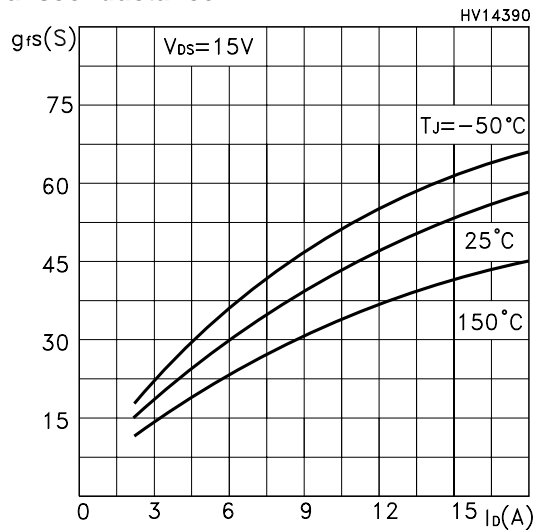

Collector-Emitter On Voltage vs Temperature

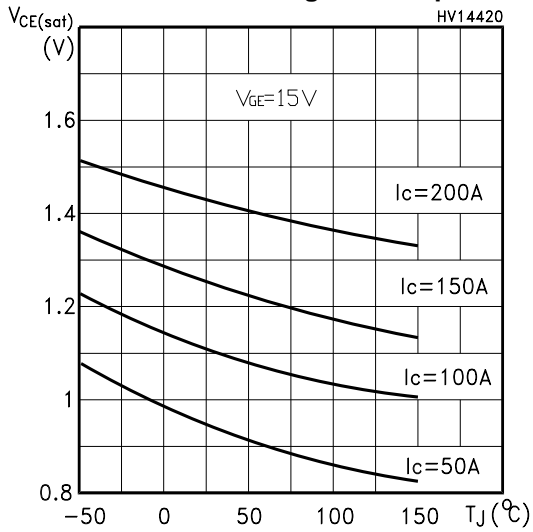

Gate-Charge vs Gate-Emitter Voltage

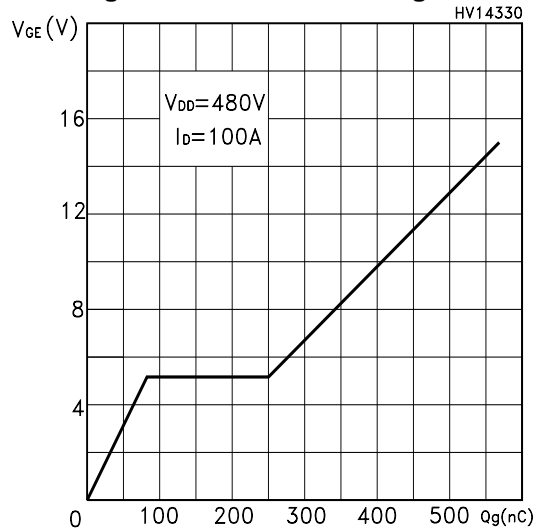

Capacitance Variations

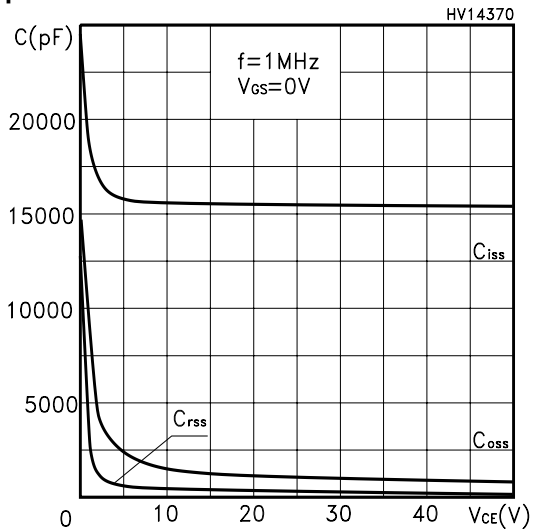

Normalized Break-down Voltage vs Temp.

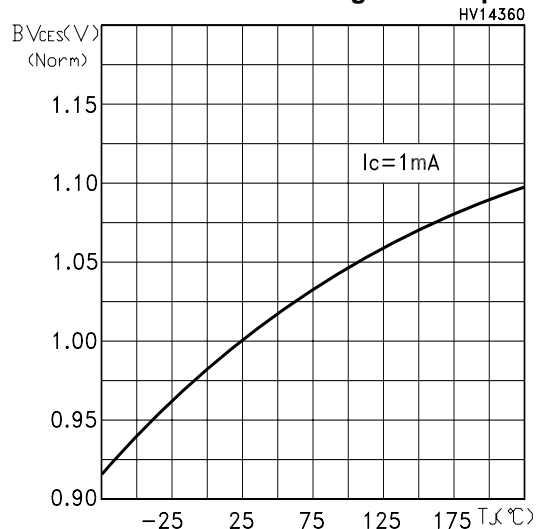

Total Switching losses vs Gate Resistance

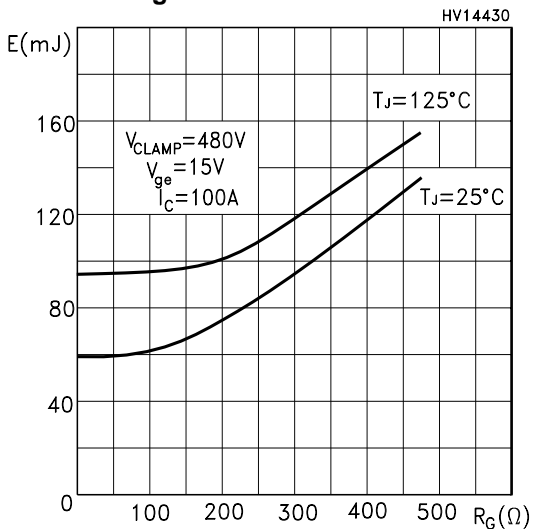

Total Switching losses vs Temperature

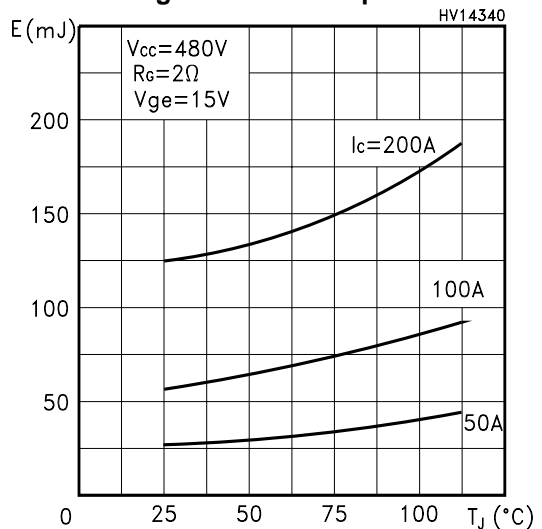

Total Switching losses vs Ic

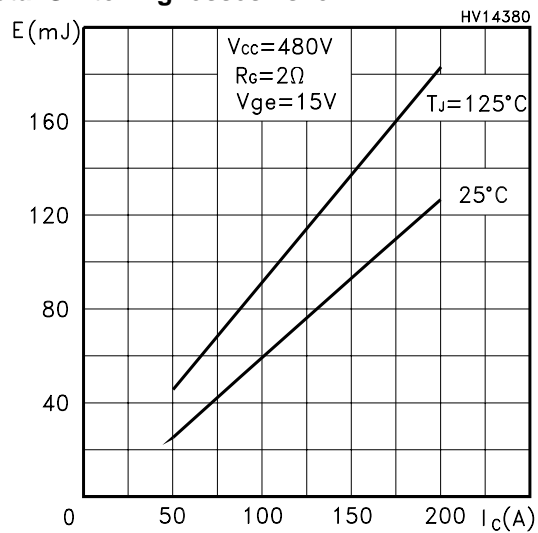

Collector-Emitter on Voltage vs Current

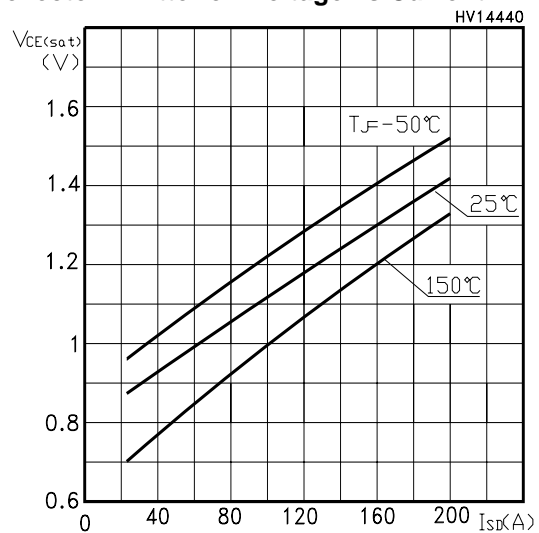

ISOTOP MECHANICAL DATA

DIM.	mm			inch		
	MIN.	TYP.	MAX.	MIN.	TYP.	MAX.
A	11.8		12.2	0.466		0.480
B	8.9		9.1	0.350		0.358
C	1.95		2.05	0.076		0.080
D	0.75		0.85	0.029		0.033
E	12.6		12.8	0.496		0.503
F	25.15		25.5	0.990		1.003
G	31.5		31.7	1.240		1.248
H	4			0.157		
J	4.1		4.3	0.161		0.169
K	14.9		15.1	0.586		0.594
L	30.1		30.3	1.185		1.193
M	37.8		38.2	1.488		1.503
N	4			0.157		
O	7.8		8.2	0.307		0.322

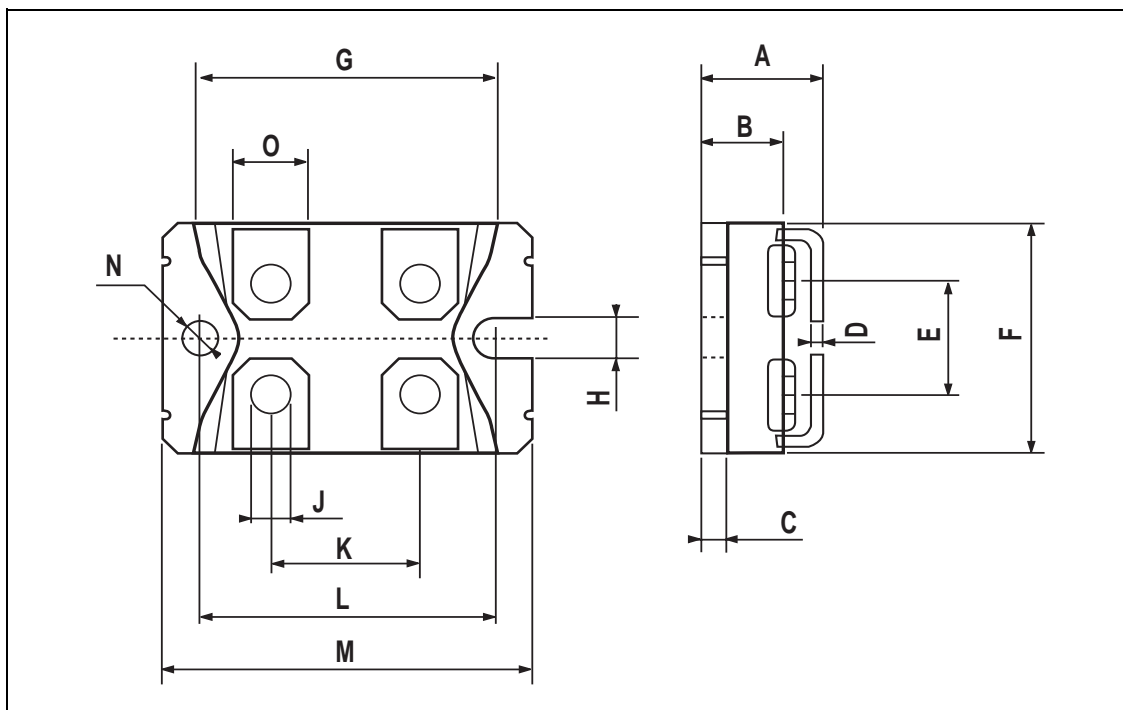

Information furnished is believed to be accurate and reliable. However, STMicroelectronics assumes no responsibility for the consequences of use of such information nor for any infringement of patents or other rights of third parties which may result from its use. No license is granted by implication or otherwise under any patent or patent rights of STMicroelectronics. Specifications mentioned in this publication are subject to change without notice. This publication supersedes and replaces all information previously supplied. STMicroelectronics products are not authorized for use as critical components in life support devices or systems without express written approval of STMicroelectronics.

© The ST logo is a registered trademark of STMicroelectronics

© 2003 STMicroelectronics - Printed in Italy - All Rights Reserved
STMicroelectronics GROUP OF COMPANIES

Australia - Brazil - Canada - China - Finland - France - Germany - Hong Kong - India - Israel - Italy - Japan - Malaysia - Malta - Morocco
Singapore - Spain - Sweden - Switzerland - United Kingdom - United States.

© <http://www.st.com>