

CR12BM

MEDIUM POWER USE
NON-INSULATED TYPE, GLASS PASSIVATION TYPE

CR12BM

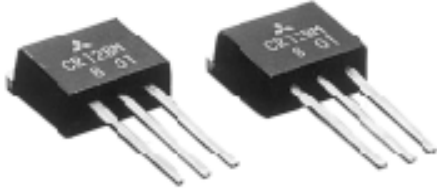

- **IT (AV)** **12A**
- **VDRM** **400V/600V**
- **IGT** **30mA**

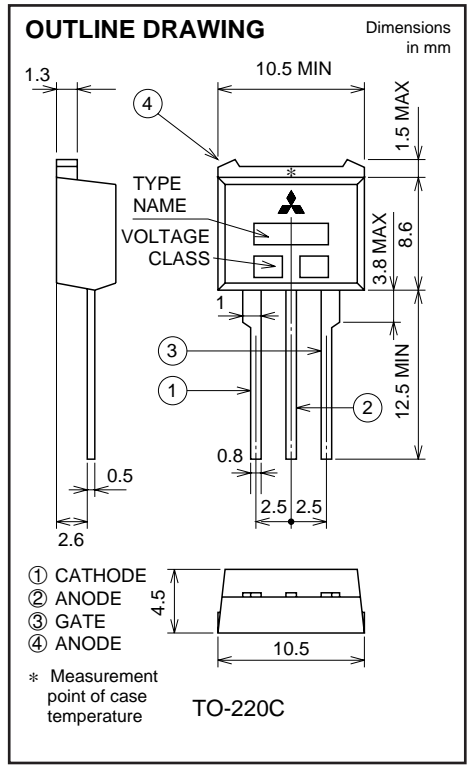

APPLICATION

Automatic strobe flasher

MAXIMUM RATINGS

Symbol	Parameter	Voltage class		Unit
		8	12	
VRRM	Repetitive peak reverse voltage	400	600	V
VRSM	Non-repetitive peak reverse voltage	500	720	V
VR (DC)	DC reverse voltage	320	480	V
VDRM	Repetitive peak off-state voltage	400	600	V
VD (DC)	DC off-state voltage	320	480	V

Symbol	Parameter	Conditions	Ratings	Unit
IT (RMS)	RMS on-state current		18.8	A
IT (AV)	Average on-state current	Commercial frequency, sine half wave, 180° conduction, Tc=91°C	12.0	A
ITSM	Surge on-state current	60Hz sine half wave 1 full cycle, peak value, non-repetitive	360	A
I ² t	I ² t for fusing	Value corresponding to 1 cycle of half wave 60Hz, surge on-state current	544	A ² s
PGM	Peak gate power dissipation		5	W
PG (AV)	Average gate power dissipation		0.5	W
VFGM	Peak gate forward voltage		6	V
VRGM	Peak gate reverse voltage		10	V
IFGM	Peak gate forward current		2	A
Tj	Junction temperature		-40 ~ +125	°C
Tstg	Storage temperature		-40 ~ +125	°C
—	Weight	Typical value	1.5	g

CR12BM

MEDIUM POWER USE
NON-INSULATED TYPE, GLASS PASSIVATION TYPE

ELECTRICAL CHARACTERISTICS

Symbol	Parameter	Test conditions	Limits			Unit
			Min.	Typ.	Max.	
IRRM	Repetitive peak reverse current	$T_j=125^\circ\text{C}$, V_{DRM} applied	—	—	2.0	mA
IDRM	Repetitive peak off-state current	$T_j=125^\circ\text{C}$, V_{DRM} applied	—	—	2.0	mA
V _{TM}	On-state voltage	$T_c=25^\circ\text{C}$, $I_{\text{TM}}=40\text{A}$	—	—	1.6	V
V _{GT}	Gate trigger voltage	$T_j=25^\circ\text{C}$, $V_D=6\text{V}$, $I_T=1\text{A}$	—	—	1.5	V
V _{GD}	Gate non-trigger voltage	$T_j=125^\circ\text{C}$, $V_D=1/2V_{\text{DRM}}$	0.2	—	—	V
I _{GT}	Gate trigger current	$T_j=25^\circ\text{C}$, $V_D=6\text{V}$, $I_T=1\text{A}$	—	—	30	mA
I _H	Holding current	$T_j=25^\circ\text{C}$, $V_D=12\text{V}$	—	15	—	mA
R _{th(j-c)}	Thermal resistance	Junction to case	—	—	1.2	°C/W
R _{th(j-a)}		Junction to ambient	—	—	70	

PERFORMANCE CURVES

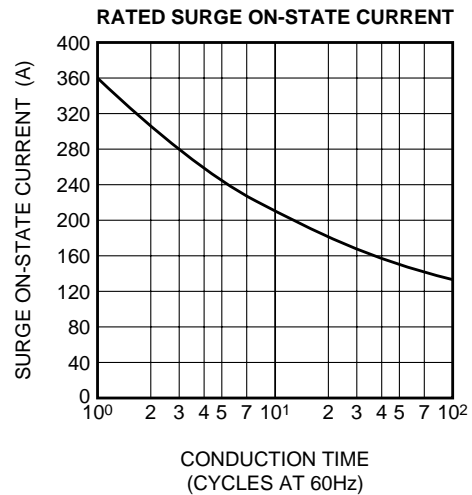
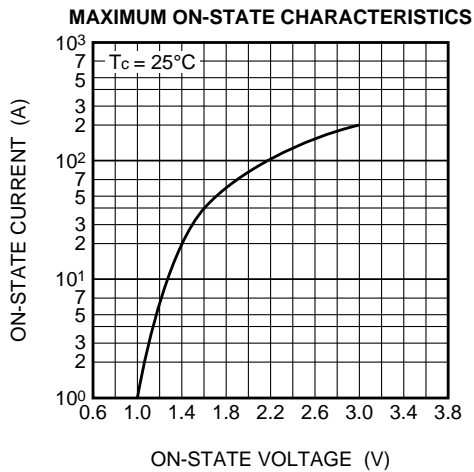

CR12BM

MEDIUM POWER USE

NON-INSULATED TYPE, GLASS PASSIVATION TYPE

GATE CHARACTERISTICS

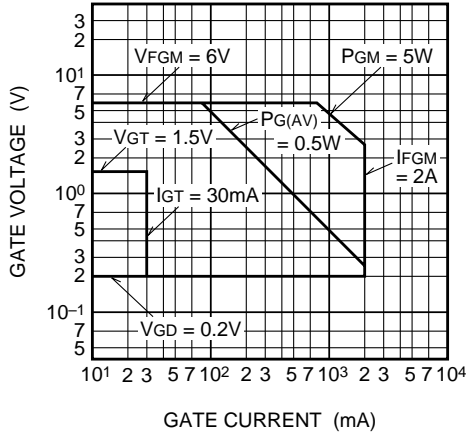

GATE TRIGGER CURRENT VS. JUNCTION TEMPERATURE

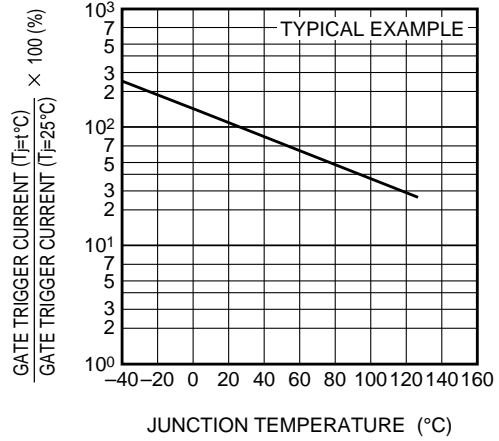

GATE TRIGGER VOLTAGE VS. JUNCTION TEMPERATURE

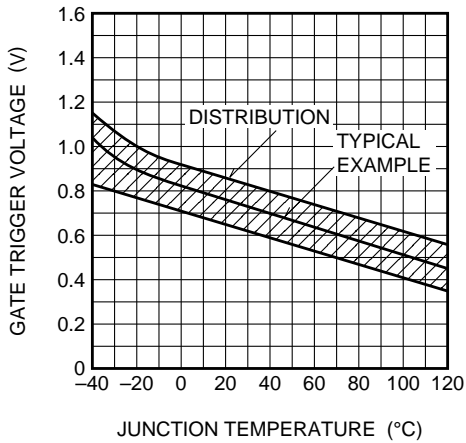

MAXIMUM TRANSIENT THERMAL IMPEDANCE CHARACTERISTICS

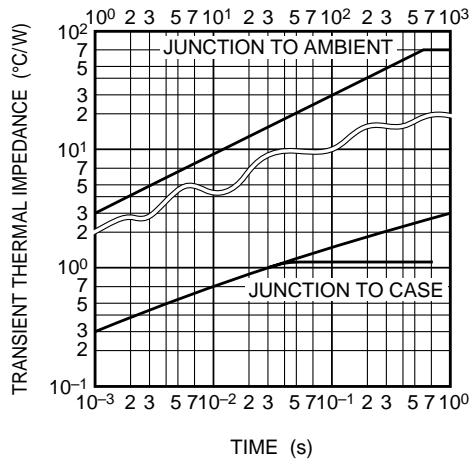

MAXIMUM AVERAGE POWER DISSIPATION (SINGLE-PHASE HALF WAVE)

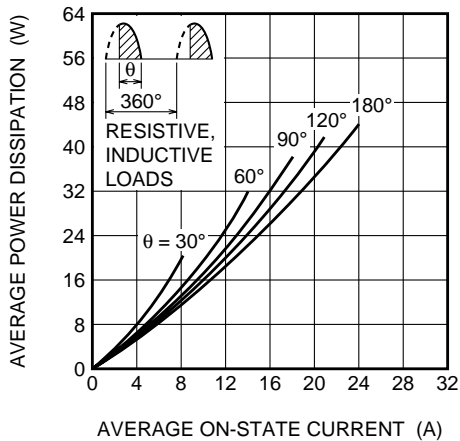

ALLOWABLE CASE TEMPERATURE VS. AVERAGE ON-STATE CURRENT (SINGLE-PHASE HALF WAVE)

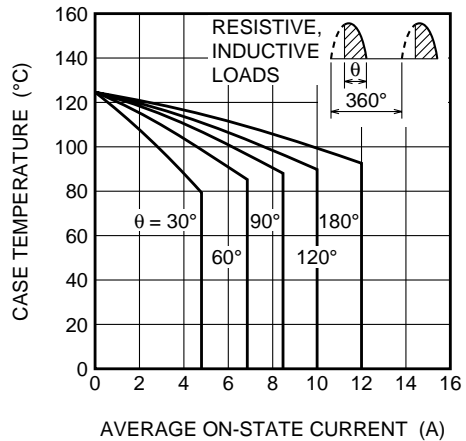

CR12BM

MEDIUM POWER USE
NON-INSULATED TYPE, GLASS PASSIVATION TYPE

ALLOWABLE AMBIENT TEMPERATURE VS. AVERAGE ON-STATE CURRENT (SINGLE-PHASE HALF WAVE)

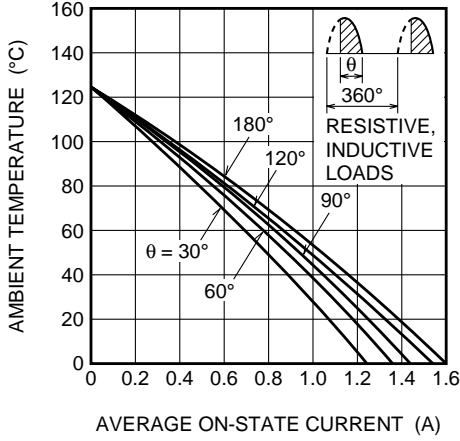

MAXIMUM AVERAGE POWER DISSIPATION (SINGLE-PHASE FULL WAVE)

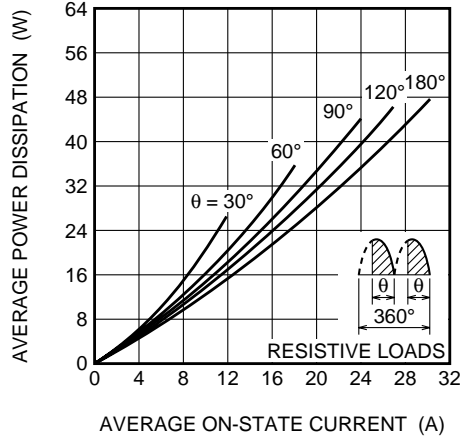

ALLOWABLE CASE TEMPERATURE VS. AVERAGE ON-STATE CURRENT (SINGLE-PHASE FULL WAVE)

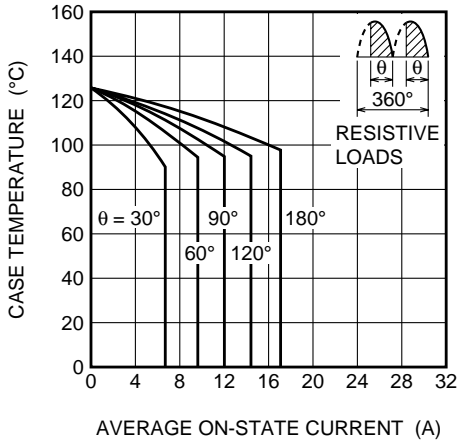

ALLOWABLE AMBIENT TEMPERATURE VS. AVERAGE ON-STATE CURRENT (SINGLE-PHASE FULL WAVE)

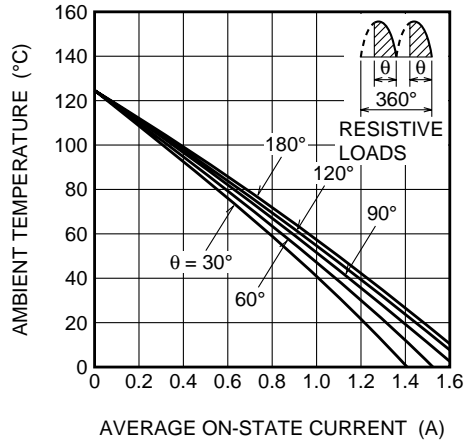

MAXIMUM AVERAGE POWER DISSIPATION (RECTANGULAR WAVE)

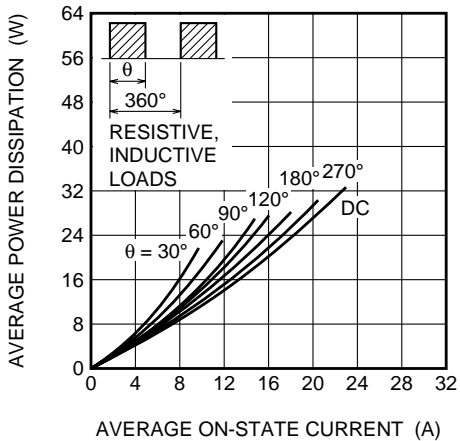

ALLOWABLE CASE TEMPERATURE VS. AVERAGE ON-STATE CURRENT (RECTANGULAR WAVE)

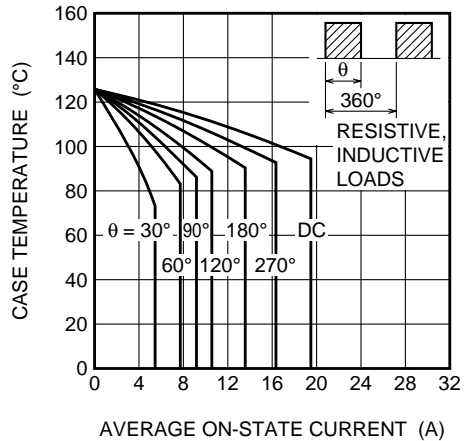

CR12BM

MEDIUM POWER USE
NON-INSULATED TYPE, GLASS PASSIVATION TYPE

ALLOWABLE AMBIENT TEMPERATURE VS. AVERAGE ON-STATE CURRENT (RECTANGULAR WAVE)

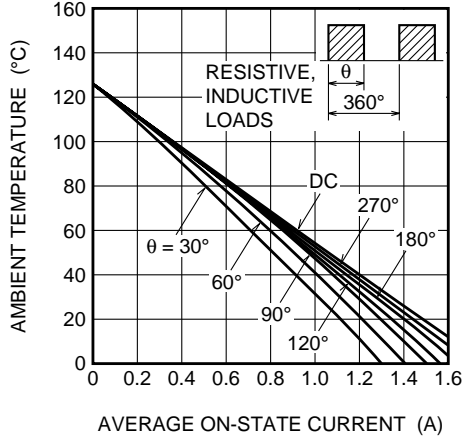

BREAKOVER VOLTAGE VS. JUNCTION TEMPERATURE

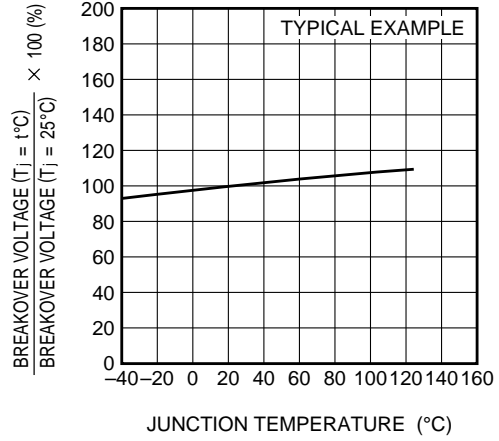

BREAKOVER VOLTAGE VS. RATE OF RISE OF OFF-STATE VOLTAGE

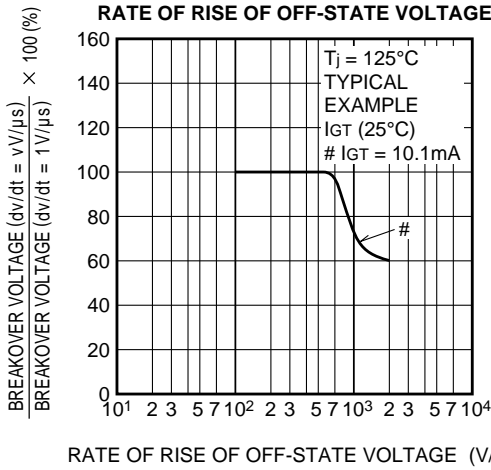

HOLDING CURRENT VS. JUNCTION TEMPERATURE

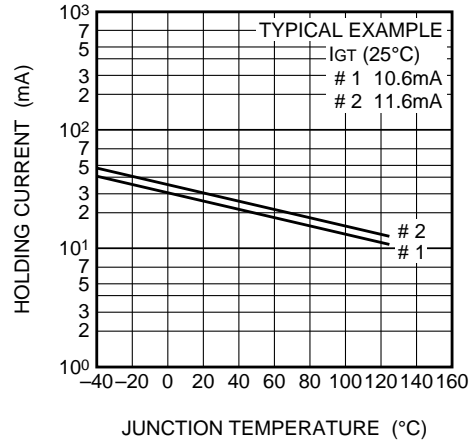

TURN-ON TIME VS. GATE CURRENT

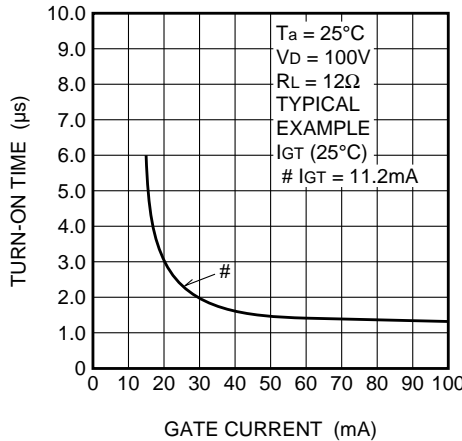

REPETITIVE PEAK REVERSE VOLTAGE VS. JUNCTION TEMPERATURE

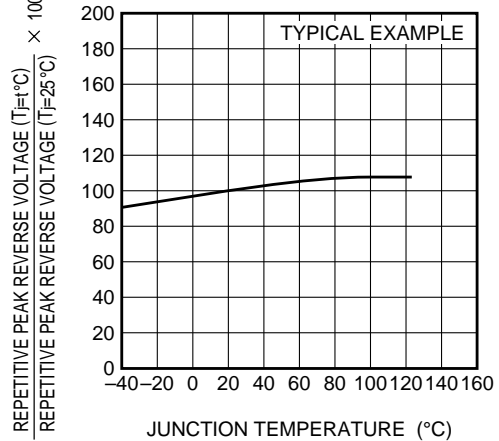

CR12BM

MEDIUM POWER USE
NON-INSULATED TYPE, GLASS PASSIVATION TYPE

