

NTSC/PAL Video Encoder

The HMP8190 and HMP8191 are NTSC and PAL encoders designed for use in systems requiring the generation of high-quality NTSC and PAL video.

YCbCr digital video data drive the P0-P15 inputs. The Y data is optionally lowpass filtered to 6MHz and drives the Y analog output. Cb and Cr are each lowpass filtered to 1.3MHz, quadrature modulated, and added together. The result drives the C analog output. The digital Y and C data are also added together and drive the composite analog output.

The DACs can drive doubly-terminated (37.5Ω) lines, and run at a 2x oversampling rate to simplify the analog output filter requirements.

Applications

- DVD Players
- Video CD Players
- Digital VCRs
- Multimedia PCs

Related Products

- NTSC/PAL Encoders
 - HMP8154, HMP8156A
 - HMP8170 – HMP8173
 - NTSC/PAL Decoders
- HMP8115, HMP8116

Ordering Information

PART NUMBER	MACROVISION v7.01	TEMP. RANGE (°C)	PACKAGE	PKG. NO.
HMP8190CN	No	0 to 70	64 Ld PQFP (Note 2)	Q64.14x14
HMP8191CN (Note 1)	Yes	0 to 70	64 Ld PQFP (Note 2)	Q64.14x14
HMP8190EVAL1 (Note 3)	Daughter Card Evaluation Platform.			

NOTES:

1. The HMP8191 may be purchased by Macrovision Authorized Buyers only. This device is protected by U.S. patent numbers 4,631,603, 4,577,216, and 4,819,098, and other intellectual property rights. The use of Macrovision's copy protection technology in the device must be authorized by Macrovision and is intended for home and other limited pay-per-view uses only, unless otherwise authorized in writing by Macrovision. Reverse engineering or disassembly is prohibited.
2. PQFP is also known as QFP and MQFP.
3. Evaluation board descriptions are in the Applications section.

Features

- (M) NTSC and (B, D, G, H, I, M, N, NC) PAL Operation
- BT.601 and Square Pixel Operation
- Digital Input Formats
 - 8-Bit, 16-Bit 4:2:2 YCbCr
 - 8-Bit BT.656
- Composite and Y/C Analog Outputs
- Flexible Video Timing Control
 - Timing Master or Slave
 - Selectable Polarity on Each Control Signal
 - Programmable Blank Output Timing
- "Sliced" VBI Data Support
 - Closed Captioning
 - Widescreen Signalling (WSS)
- Three 2x Oversampling, 10-Bit DACs
 - Fast I²C Interface

Functional Block Diagram

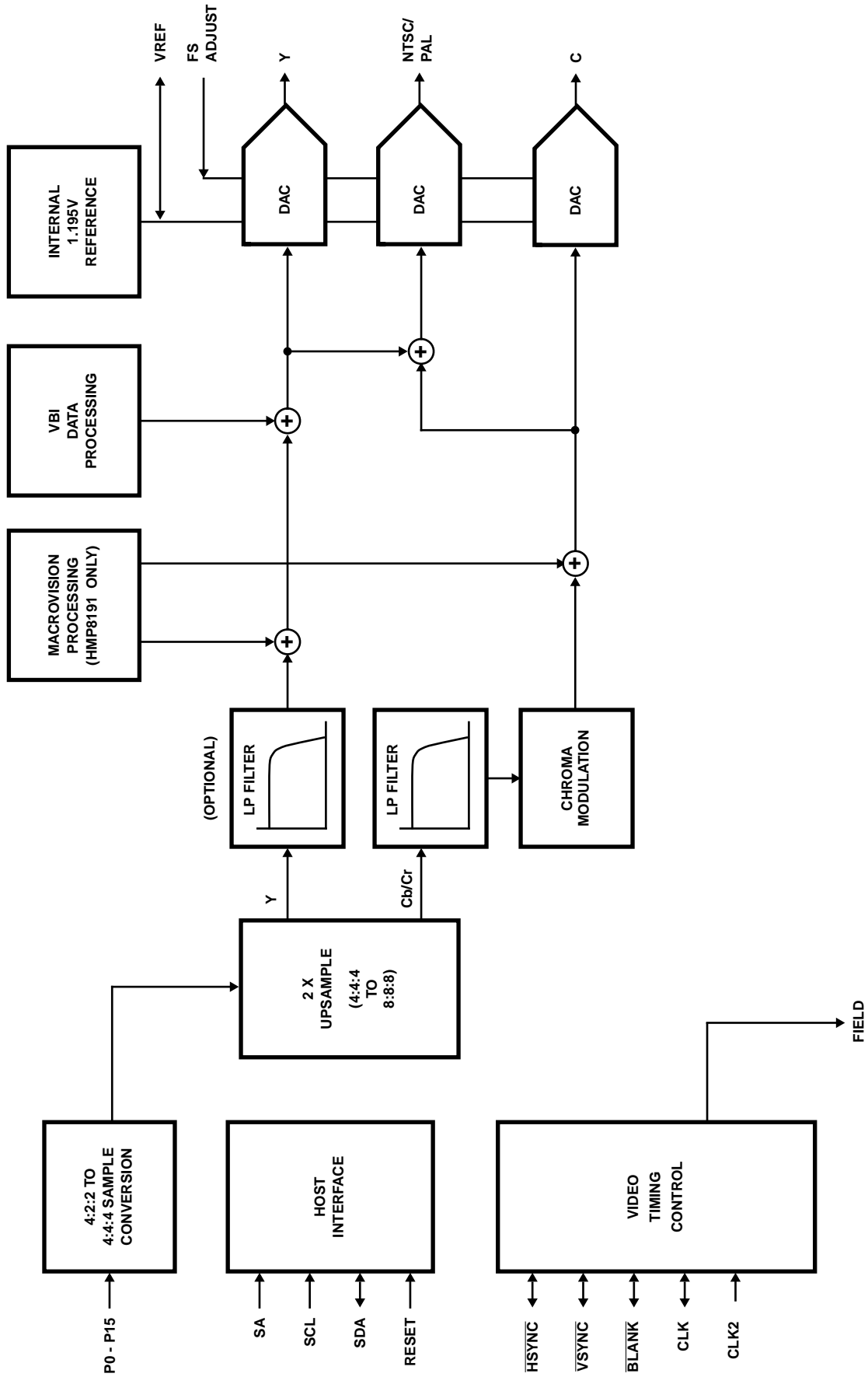

Functional Operation

The HMP8190 and HMP8191 are fully integrated digital encoders. Both accept YCbCr digital video input data and generate analog video output signals. The three outputs are one composite video signal and Y/C (S-Video).

The HMP8190/HMP8191 accepts pixel data in one of several formats and transforms it into 4:4:4 sampled luminance and chrominance (YCbCr) data. The encoder then interpolates the YCbCr data to twice the pixel rate and low pass filters it to match the bandwidth of the video output format. If enabled, the encoder also adds vertical blanking interval (VBI) information to the Y data. At the same time, the encoder modulates the chrominance data with a digitally synthesized subcarrier. Finally, the encoder outputs luminance, chrominance, and their sum as analog signals using 10-bit D/A converters.

The HMP8190/HMP8191 provides operating modes to support all versions of the NTSC and PAL standards and accepts full size input data with rectangular (BT.601) and square pixel aspect ratios. It operates from a single clock at twice the pixel clock rate determined by the operating mode.

The HMP8190/HMP8191's video timing control is flexible. It may operate as the master, generating the system's video timing control signals, or it may accept external timing controls. The polarity of the timing controls and the number of active pixels and lines are programmable.

Pixel Data Input

The HMP8190/HMP8191 accepts BT.601 YCbCr pixel data via the P0-P15 input pins. The definition of each pixel input pin is determined by the input format selected in the input format register. The definition for each mode is shown in Table 1.

The YCbCr luminance and color difference signals are each 8 bits, scaled 0 to 255. The nominal range for Y is 16 (black) to 235 (white). Y values less than 16 are clamped to 16; values greater than 235 are processed normally. The nominal range for Cb and Cr is 16 to 240 with 128 representing zero. Cb and Cr values outside their nominal range are processed normally. Note that when converted to the analog outputs, some combinations of YCbCr outside their nominal ranges would generate a composite video signal larger than the analog output limit. The composite signal will be clipped but the S-video outputs (Y and C) will not be.

The color difference signals are time multiplexed into one 8-bit bus beginning with a Cb sample. The Y and CbCr busses may be input in parallel (16-bit mode) or may be time multiplexed and input as a single bus (8-bit mode). The single bus may also contain SAV and EAV video timing reference codes or ancillary data (BT.656 mode).

TABLE 1. PIXEL DATA INPUT FORMATS

PIN NAME	16-BIT	8-BIT	BT.656
	4:2:2 YCBCR	4:2:2 YCBCR	
P0	Cb0, Cr0	Ignored	
P1	Cb1, Cr1		
P2	Cb2, Cr2		
P3	Cb3, Cr3		
P4	Cb4, Cr4		
P5	Cb5, Cr5		
P6	Cb6, Cr6		
P7	Cb7, Cr7		
P8	Y0	Y0, Cb0, Cr0	YCbCr Data, SAV and EAV Sequences, and Ancillary Data
P9	Y1	Y1, Cb1, Cr1	
P10	Y2	Y2, Cb2, Cr2	
P11	Y3	Y3, Cb3, Cr3	
P12	Y4	Y4, Cb4, Cr4	
P13	Y5	Y5, Cb5, Cr5	
P14	Y6	Y6, Cb6, Cr6	
P15	Y7	Y7, Cb7, Cr7	

Pixel Input and Control Signal Timing

The pixel input timing and the video control signal input/output timing of the HMP8190/HMP8191 depend on the part's operating mode. The periods when the encoder samples its inputs and generates its outputs are summarized in Table 2.

Figures 1, 2, and 3 show the timing of CLK, CLK2, $\overline{\text{BLANK}}$, and the pixel input data with respect to each other. $\overline{\text{BLANK}}$ may be an input or an output; the figures show both. When it is an input, $\overline{\text{BLANK}}$ must arrive coincident with the pixel input data; all are sampled at the same time.

When $\overline{\text{BLANK}}$ is an output, its timing with respect to the pixel inputs depends on the blank timing select bit in the timing_I/O_1 register. If the bit is cleared, the HMP8190/HMP8191 negates $\overline{\text{BLANK}}$ one CLK cycle before it samples the pixel inputs.

If the bit is set, the encoder negates $\overline{\text{BLANK}}$ during the same CLK cycle in which it samples the input data. In effect, the input data must arrive one CLK cycle earlier than when the bit is cleared. This mode is not shown in the figures.

TABLE 2. PIXEL INPUT AND CONTROL SIGNAL I/O TIMING

INPUT FORMAT	INPUT PIXEL DATA SAMPLE	VIDEO TIMING CONTROL (NOTE 1)		CLK FREQUENCY	
		INPUT SAMPLE	OUTPUT ON	INPUT	OUTPUT
16-Bit YCbCr	Rising edge of CLK2 when CLK is low		Rising edge of CLK2 when CLK is high.	One-half CLK2	
8-Bit YCbCr	Every rising edge of CLK2	Every rising edge of CLK2	Any rising edge of CLK2	Ignored	One-half CLK2
BT.656	Every rising edge of CLK2	Not Allowed	Any rising edge of CLK2	Ignored	One-half CLK2

NOTE: Video timing control signals include HSYNC, VSYNC, $\overline{\text{BLANK}}$ and FIELD. The sync and blanking I/O directions are independent; FIELD is always an output.

8-Bit YCbCr Format

When 8-bit YCbCr format is selected, the data is latched on each rising edge of CLK2. The pixel data must be [Cb Y Cr Y' Cb Y Cr Y' . . .], with the first active data each scan line being Cb data. The pixel input timing is shown in Figure 1.

As inputs, $\overline{\text{BLANK}}$, $\overline{\text{HSYNC}}$, and $\overline{\text{VSYNC}}$ are latched on each rising edge of CLK2. As outputs, $\overline{\text{BLANK}}$, $\overline{\text{HSYNC}}$, and $\overline{\text{VSYNC}}$ are output following the rising edge of CLK2. If the CLK pin is configured as an input, it is ignored. If configured as an output, it is one-half the CLK2 frequency.

16-Bit YCbCr Format

When 16-bit YCbCr format is selected, the pixel data is latched on the rising edge of CLK2 while CLK is low. The pixel input timing is shown in Figure 2.

As inputs, $\overline{\text{BLANK}}$, $\overline{\text{HSYNC}}$, and $\overline{\text{VSYNC}}$ are latched on the rising edge of CLK2 while CLK is low. As outputs, $\overline{\text{HSYNC}}$, $\overline{\text{VSYNC}}$, and $\overline{\text{BLANK}}$ are output following the rising edge of CLK2 while CLK is high. In these modes of operation, CLK is one-half the CLK2 frequency.

8-Bit BT.656 Format

When BT.656 format is selected, data is latched on each rising edge of CLK2. The pixel input timing is shown in Figure 3. The figure shows the EAV code at the end of the line. The format of the SAV and EAV codes are shown in Table 3.

The BT.656 input may also include ancillary data to load the VBI or RTC1 data registers. The HMP8190/HMP8191 will use the ancillary data when enabled in the VBI data input and timing I/O registers. The ancillary data formats and the enable registers are described later in this datasheet.

As inputs, the $\overline{\text{BLANK}}$, $\overline{\text{HSYNC}}$, and $\overline{\text{VSYNC}}$ pins are ignored since all timing is derived from the EAV and SAV sequences within the data stream. As outputs, $\overline{\text{BLANK}}$, $\overline{\text{HSYNC}}$ and $\overline{\text{VSYNC}}$ are output following the rising edge of CLK2. If the CLK pin is configured as an input, it is ignored. If configured as an output, it is one-half the CLK2 frequency.

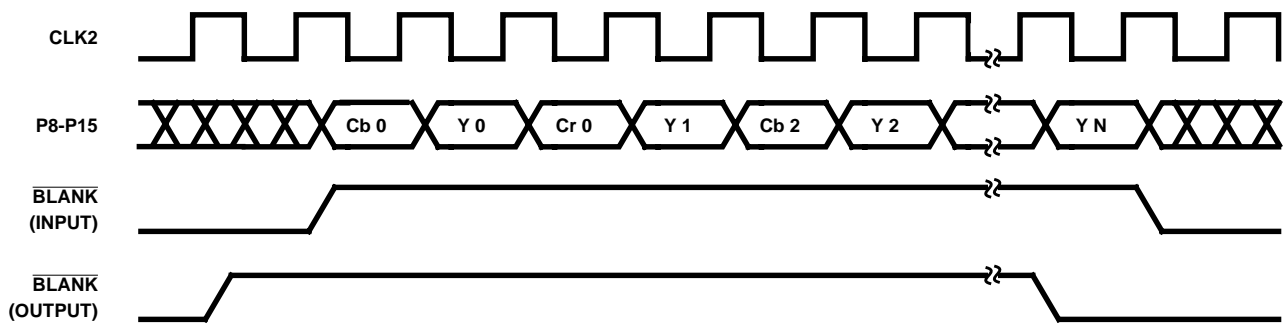

FIGURE 1. PIXEL INPUT TIMING - 8-BIT YCBCR

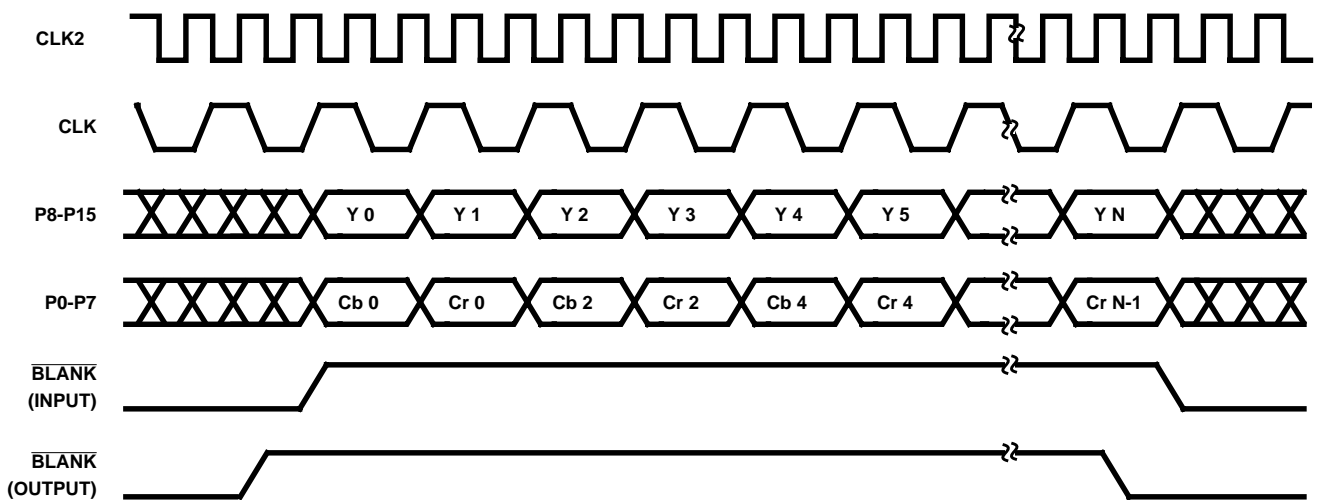

FIGURE 2. PIXEL INPUT TIMING - 16-BIT YCBCR

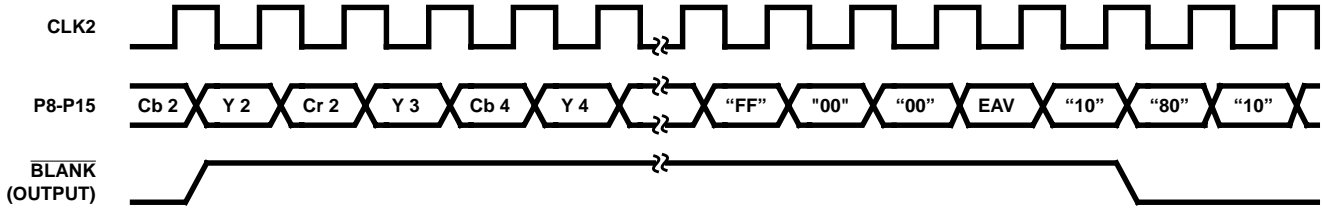

FIGURE 3. PIXEL INPUT TIMING - BT.656

TABLE 3. BT.656 EAV AND SAV SEQUENCES

PIXEL INPUT	P15	P14	P13	P12	P11	P10	P9	P8
Preamble Word 1	1	1	1	1	1	1	1	1
Preamble Word 2	0	0	0	0	0	0	0	0
Preamble Word 3	0	0	0	0	0	0	0	0
Status Word	1	F	V	H	P3	P2	P1	P0

NOTE:

F: 0 = Field 1; 1 = Field 2

V: 0 = Active Line; 1 = Vertical Blanking

H: 0 = Start Active Video; 1 = End Active Video

P3 - P0: Protection bits; Ignored

Video Timing Control

The pixel input data and the output video timing of the HMP8190/HMP8191 are at 50 or 59.94 fields per second interlaced. The timing is controlled by the $\overline{\text{BLANK}}$, $\overline{\text{HSYNC}}$, $\overline{\text{VSYNC}}$, FIELD, and CLK2 pins.

$\overline{\text{HSYNC}}$, $\overline{\text{VSYNC}}$, and Field Timing

The leading edge of $\overline{\text{HSYNC}}$ indicates the beginning of a horizontal sync interval. If $\overline{\text{HSYNC}}$ is an output, it is asserted for about 4.7 μs . If $\overline{\text{HSYNC}}$ is an input, it must be active for at least two CLK2 periods. The width of the analog horizontal sync tip is determined from the video standard and does not depend on the width of $\overline{\text{HSYNC}}$.

The leading edge of $\overline{\text{VSYNC}}$ indicates the beginning of a vertical sync interval. If $\overline{\text{VSYNC}}$ is an output, it is asserted for 3 scan lines in (MM) NTSC and (M, N) PAL modes or 2.5 scan lines in (B, D, G, H, I, NC) PAL modes. If $\overline{\text{VSYNC}}$ is an input, it must be asserted for at least two CLK2 periods.

When $\overline{\text{HSYNC}}$ and $\overline{\text{VSYNC}}$ are configured as outputs, their leading edges will occur simultaneously at the start of an odd field. At the start of an even field, the leading edge of $\overline{\text{VSYNC}}$ occurs in the middle of the line.

When $\overline{\text{HSYNC}}$ and $\overline{\text{VSYNC}}$ are configured as inputs, the HMP8190/HMP8191 provides a programmable $\overline{\text{HSYNC}}$ window for determining FIELD. The window is specified with respect to the leading or trailing edge of $\overline{\text{VSYNC}}$. The edge is selected in the field control register. When $\overline{\text{HSYNC}}$ is found inside the window, then the encoder sets FIELD to the value specified in the field control register.

The HMP8190/HMP8191 provides programmable timing for the $\overline{\text{VSYNC}}$ input. At the active edge of $\overline{\text{VSYNC}}$, the encoder resets its vertical half-line counter to the value specified by the field control register. This allows the input and output syncs to be offset, although the data must still be aligned.

The FIELD signal is always an output and changes state near each leading edge of $\overline{\text{VSYNC}}$. The delay between the syncs and FIELD depends on the encoder's operating mode as summarized in Table 4. In modes in which the encoder uses CLK to gate its inputs and outputs, the FIELD signal may be delayed 0-12 additional CLK2 periods.

TABLE 4. FIELD OUTPUT TIMING

OPERATING MODE		CLK2 DELAY	COMMENTS
SYNC I/O DIRECTION	BLANK I/O DIRECTION		
Input	Input	148	FIELD lags $\overline{\text{VSYNC}}$ switching from odd to even. FIELD lags the earlier of $\overline{\text{VSYNC}}$ and $\overline{\text{HSYNC}}$ when syncs are aligned when switching from even to odd.
Input	Output	138	FIELD lags $\overline{\text{VSYNC}}$.
Output	Don't Care	32	FIELD leads $\overline{\text{VSYNC}}$.

Figure 4 illustrates the $\overline{\text{HSYNC}}$, $\overline{\text{VSYNC}}$, and FIELD general timing for (M) NTSC and (M, N) PAL. Figure 5 illustrates the general timing for (B, D, G, H, I, NC) PAL. In the figures, all the signals are shown active low (their reset state), and FIELD is low during odd fields.

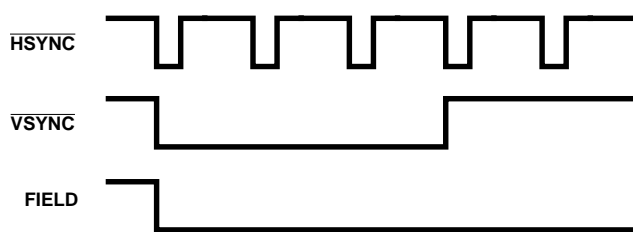

FIGURE 4A. BEGINNING AN ODD FIELD

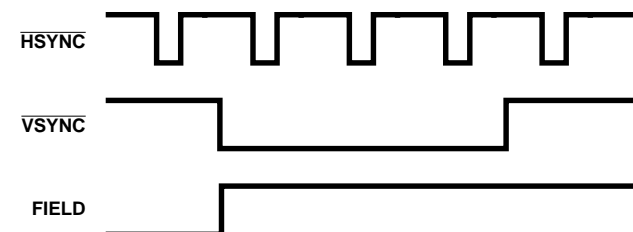

FIGURE 4B. BEGINNING AN EVEN FIELD

FIGURE 4. $\overline{\text{HSYNC}}$, $\overline{\text{VSYNC}}$, AND FIELD TIMING FOR (M) NTSC AND (M, N) PAL

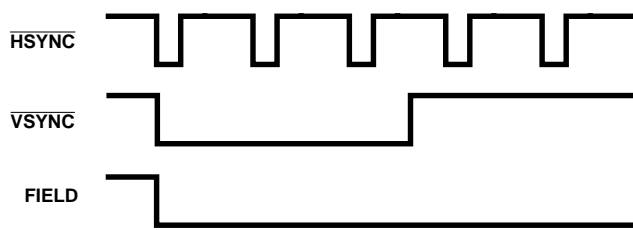

FIGURE 5A. BEGINNING AN ODD FIELD

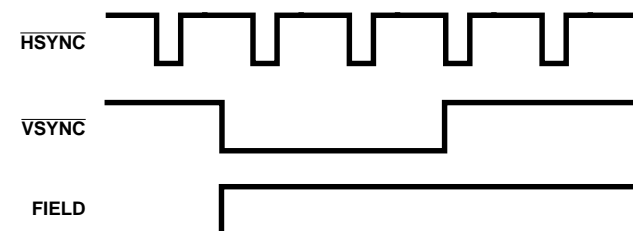

FIGURE 5B. BEGINNING AN EVEN FIELD

FIGURE 5. $\overline{\text{HSYNC}}$, $\overline{\text{VSYNC}}$, AND FIELD TIMING FOR (B, D, G, H, I, NC) PAL

BLANK TIMING

The encoder uses the $\overline{\text{HSYNC}}$, $\overline{\text{VSYNC}}$, FIELD signals to generate a standard composite video waveform with no active video (black burst). The signal includes only sync tips, color burst, and optionally, a 7.5 IRE blanking setup. Based on the $\overline{\text{BLANK}}$ signal, the encoder adds the pixel input data to the video waveform.

The encoder ignores the pixel input data when $\overline{\text{BLANK}}$ is asserted. Instead of the input data, the encoder generates the blanking level. The encoder also ignores the pixel inputs when generating VBI data on a specific line, even if $\overline{\text{BLANK}}$ is negated.

There must be an even number of active and total pixels per line. In the 8-bit YCbCr modes, the number of active and total pixels per line must be a multiple of four. Note that if $\overline{\text{BLANK}}$ is an output, half-line blanking on the output video cannot be done.

The HMP8190/HMP8191 never adds the programmable blanking setup during the active line time on scan lines 1-21 and 263-284 for (M) NTSC, scan lines 523-18 and 260-281 for (M) PAL, and scan lines 623-22 and 311-335 for (B, D, G, H, I, N) PAL, allowing the generation of video test signals, timecode, and other information by controlling the pixel inputs appropriately.

The relative timing of $\overline{\text{BLANK}}$, $\overline{\text{HSYNC}}$, and the output video depends on the blanking and sync I/O directions. The typical timing relation is shown in Figure 6. The delays which vary with operating mode are indicated. The width of the composite sync tip and the location and duration of the color burst are fixed based on the video format.

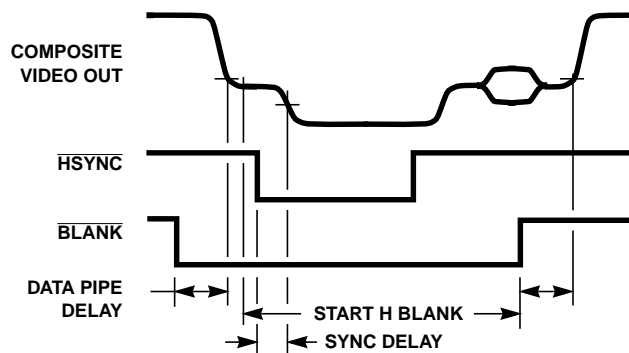

FIGURE 6. $\overline{\text{HSYNC}}$, $\overline{\text{BLANK}}$, AND OUTPUT VIDEO TIMING, NORMAL MODE

When $\overline{\text{BLANK}}$ is an output, the encoder asserts it during the inactive portions of active scan lines (horizontal blanking) and for all of each inactive scan line (vertical blanking). The inactive scan lines blanked each field are determined by the start_v_blank and end_v_blank registers. The inactive portion of active scan lines is determined by the start_h_blank and end_h_blank registers.

The zero count for horizontal blanking is 32 CLK2 cycles before the 50% point of the composite sync. From this zero point, the HMP8190/HMP8191 counts every other CLK2 cycle. When the count reaches the value in the start_h_blank register, the encoder negates $\overline{\text{BLANK}}$. When the count reaches the value in the end_h_blank register, $\overline{\text{BLANK}}$ is asserted. There may be an additional 0-3 CLK2 delays in modes which use CLK.

The data pipeline delay through the HMP8190/HMP8191 is 26 CLK2 cycles. In operating modes which use CLK to gate the inputs into the encoder, the delay may be an additional 0-7 CLK2 cycles. The delay from $\overline{\text{BLANK}}$ to the start or end of active video is an additional one-half CLK cycle when the blank timing select bit is cleared. The active video may also appear to end early or start late since the HMP8190/HMP8191 controls the blanking edge rates.

TABLE 5. TYPICAL VIDEO TIMING PARAMETERS

VIDEO STANDARD	PIXELS PER LINE		HBLANK REGISTER VALUES		VBLANK REGISTER VALUES		CLK2 (MHz)
	TOTAL	ACTIVE	START	END	START	END	
RECTANGULAR PIXELS (BT.601)							
(M) NTSC	858	720	842 (0x34a)	122 (0x7a)	259 (0x103)	19 (0x13)	27.0
(B, D, G, H, I) PAL	864	720	853 (0x355)	133 (0x85)	310 (0x136)	22 (0x16)	27.0
(M) PAL	858	720	842 (0x34a)	122 (0x7a)	259 (0x103)	19 (0x13)	27.0
(N) PAL	864	720	853 (0x355)	133 (0x85)	309 (0x135)	21 (0x15)	27.0
(NC) PAL	864	720	853 (0x355)	133 (0x85)	310 (0x136)	22 (0x16)	27.0
SQUARE PIXELS							
(M) NTSC	780	640	758 (0x2f6)	118 (0x76)	259 (0x103)	19 (0x13)	24.54
(B, D, G, H, I) PAL	944	768	923 (0x39b)	155 (0x9b)	310 (0x136)	22 (0x16)	29.5
(M) PAL	780	640	758 (0x2f6)	118 (0x76)	259 (0x103)	19 (0x13)	24.54
(N) PAL	944	768	923 (0x39b)	155 (0x9b)	309 (0x135)	21 (0x15)	29.5
(NC) PAL	944	768	923 (0x39b)	155 (0x9b)	310 (0x136)	22 (0x16)	29.5

The delay from the active edge of HSYNC to the 50% point of the composite sync is 4-39 CLK2 cycles depending on the HMP8190/HMP8191 operating mode. The delay is shortest when the encoder is the timing master; it is longest when in slave mode.

CLK2 Input Timing

The CLK2 input clocks all of the HMP8190/HMP8191, including its video timing counters. For proper operation, all of the HMP8190/HMP8191 inputs must be synchronous with CLK2. The frequency of CLK2 depends on the device's operating mode and the total number of pixels per line. The standard clock frequencies are shown in Table 5.

Note that the color subcarrier is derived from the CLK2 input. Any jitter on CLK2 will be transferred to the color subcarrier, resulting in color changes. Just 400ps of jitter on CLK2 causes up to a 1 degree color subcarrier phase shift. Thus, CLK2 should be derived from a stable clock source, such as a crystal. The use of a PLL to generate CLK2 is not recommended.

Video Processing

Upsampling

The encoder begins the video processing with the pixel input data. It converts the 4:2:2 YCbCr data to 4:4:4 data. The conversion is done by 2x upsampling the Cb and Cr data. The CbCr upsampling function uses linear interpolation. The HMP8190/HMP8191 then upsamples the 4:4:4 data to generate 8:8:8 data. Again, the encoder uses linear interpolation for the upsampling.

Horizontal Filtering

Unless disabled, the HMP8190/HMP8191 lowpass filters the Y data to 6.0MHz. Lowpass filtering Y removes any aliasing artifacts due to the upsampling process, and simplifies the analog output filters. The Y 6.0MHz lowpass filter response is shown in Figure 8. At this point, the HMP8190/HMP8191 also scales the Y data to generate the proper output levels for the various video standards.

The HMP8190/HMP8191 lowpass filters the Cb and Cr data to 1.3MHz prior to modulation. The lowpass filtering removes any aliasing artifacts due to the upsampling process (simplifying the analog output filters) and also properly bandwidth-limits Cb and Cr prior to modulation. The chrominance filtering is not optional like luminance filtering. The Cb and Cr 1.3MHz lowpass filter response is shown in Figure 9.

Color Subcarrier Generation

The HMP8190/HMP8191 uses a numerically controlled oscillator (NCO) clocked by CLK2 and a sine look up ROM to generate the color subcarrier. As shown in Figure 7, the phase increment value (PHINC) of the NCO may come from the encoder's internal look up table, BT.656 ancillary data, or a control register. The PHINC source is selected in timing I/O register 2.

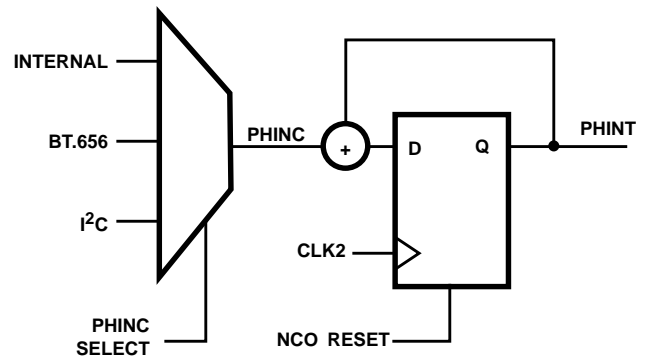

FIGURE 7. COLOR SUBCARRIER GENERATION NCO

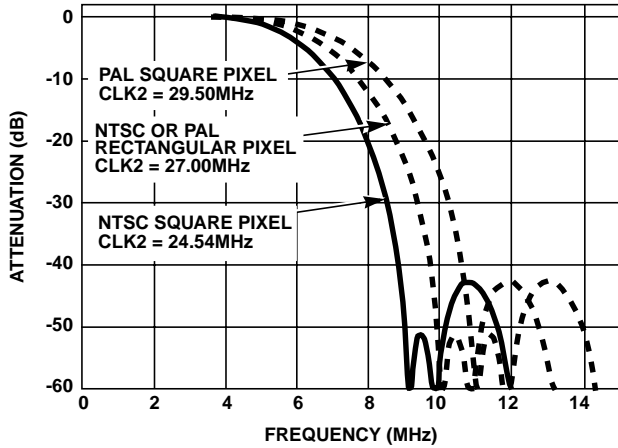

FIGURE 8A. FULL SPECTRUM

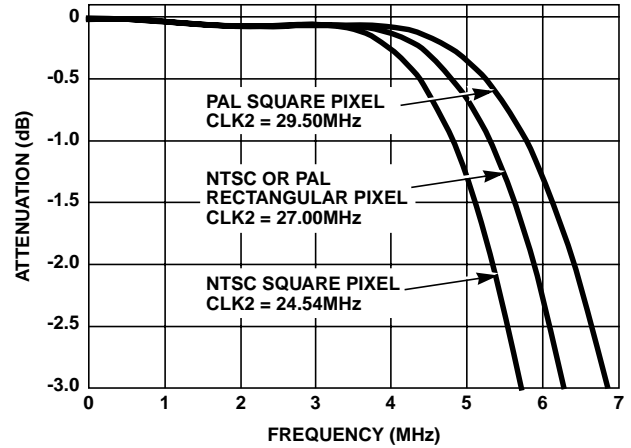

FIGURE 8B. PASS BAND

FIGURE 8. Y LOWPASS FILTER RESPONSE

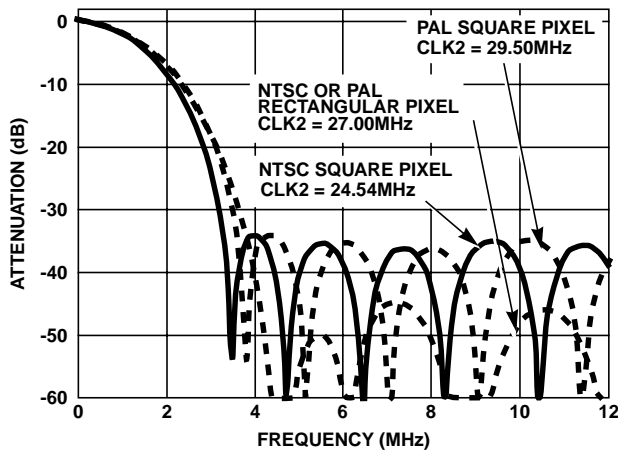

FIGURE 9A. FULL SPECTRUM

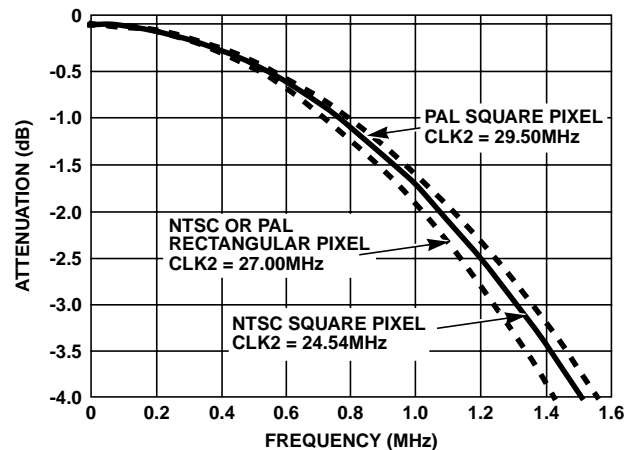

FIGURE 9B. PASS BAND

FIGURE 9. Cb AND Cr LOWPASS FILTER RESPONSE

The MSBs of the accumulated phase value (PHINT) are used to address the encoder's sine look up ROM. The sine values from the ROM are pre-scaled to generate the proper levels for the various video standards. Prescaling outside the CbCr data path minimizes color processing artifacts. The HMP8190/HMP8191 modulates the filtered 8:8:8 chrominance data with the synthesized subcarrier.

The SCH phase is 0 degrees after reset but then changes monotonically over time due to residue in the NCO. In an ideal system, zero SCH phase would be maintained forever. In reality, this is impossible to achieve due to pixel clock frequency tolerances and digital rounding errors. When the PHINC source is BT.656 data, the SCH phase reset should be disabled.

If enabled, the HMP8190/HMP8191 resets the NCO periodically to avoid an accumulation of SCH phase error. The reset occurs at the beginning of each field to burst phase sequence. The sequence repeats every 4 fields for NTSC or 8 fields for PAL.

Resetting the SCH phase every four fields (NTSC) or eight fields (PAL) avoids the accumulation of SCH phase error at the expense of requiring any NTSC/PAL decoder after the encoder be able to handle very minor "jumps" (up to 2 degrees) in the SCH phase at the beginning of each four-field or eight-field sequence. Most NTSC/PAL decoders are able to handle this due to video editing requirements.

Composite Video Limiting

The HMP8190/HMP8191 adds the luminance and modulated chrominance together with the sync, color burst, and optional blanking pedestal to form the composite video data. If enabled in the video processing register, the encoder limits the active video so that it is always greater than one-eighth of full scale. This corresponds to approximately one-half the sync height. This allows the generation of "safe" video in the event non-standard YCbCr values are input to the device.

Controlled Edges

The NTSC and PAL video standards specify edge rates and rise and fall times for portions of the video waveform. The HMP8190/HMP8191 automatically implements controlled edge rates and rise and fall times on these edges:

1. Analog horizontal sync (rising and falling edges)
2. Analog vertical sync interval (rising and falling edges)
3. Color burst envelope
4. Blanking of analog active video
5. Closed captioning information
6. WSS Information

“Sliced” VBI Data

The HMP8190/HMP8191 generates two types of vertical blanking interval data: closed captioning and widescreen signalling. The data is generated when enabled in the VBI data control register. It is placed on the scan lines specified by the selected output video standard. During scan lines with VBI data, the pixel inputs are ignored.

Closed Captioning (CC)

The HMP8190/HMP8191 captioning data output includes clock run-in and start bits followed by the captioning data. During closed captioning encoding, the pixel inputs are ignored on the scan lines containing captioning information.

The HMP8190/HMP8191 has two 16-bit registers containing the captioning information. Each 16-bit register is organized as two cascaded 8-bit registers. One 16-bit register (caption 21) is read out serially during line 18, 21 or 22; the other 16-bit register (WSS 284) is read out serially during line 281, 284 or 335. The data registers are shifted out LSB first.

The captioning output level is 50 IRE for a logic 1 and 0 IRE for a logic 0. All transitions between levels are controlled to have a raised-cosine shape. The rise or fall time of any transition is 240-288ns.

The caption data registers may be loaded via the I²C interface or as BT.656 ancillary data. Table 6 illustrates the format of the caption data as BT.656 ancillary data. The transfer should occur only once per field before the start of the SAV sequence of the line containing the captioning output.

When written via the I²C interface, the bytes may be written in any order but both must be written within one frame time for proper operation. If the registers are not updated, the encoder resends the previously loaded values.

The HMP8190/HMP8191 provides a write status bit for each captioning line. The encoder clears the write status bit to '0' when captioning is enabled and both bytes of the captioning data register have been written. The encoder sets the write status bit to '1' after it outputs the data, indicating the registers are ready to receive new data.

Captioning information may be enabled for either line, both lines, or no lines. The captioning modes are summarized in Table 7.

Widescreen Signalling (WSS)

The HMP8190/HMP8191 WSS data output includes clock run-in and start codes followed by the WSS data. For NTSC operation, the WSS data is followed by six bits of CRC data.

The HMP8190/HMP8191 has two 14-bit registers containing the WSS information and two 6-bit registers containing the WSS CRC data. Each 14-bit register is organized as a 6-bit register cascaded with an 8-bit one. One 14-bit register (WSS 20) is read out serially during line 17, 20 or 23; the other 14-bit register (caption 283) is read out serially during line 280, 283 or 336. The data registers are shifted out LSB first.

The WSS output level depends on the video format. For NTSC operation (EIAJ CPX-1204), the WSS output level is 70 IRE for a logic 1 and 0 IRE for a logic 0. All transitions between levels are controlled to have a raised-cosine shape with a rise or fall time of 240ns. For PAL operation (ITU-R BT.1119), the WSS output level is 71.5 IRE for a logic 1 and 0 IRE for a logic 0. All transitions between levels are controlled to have a raised-cosine shape with a rise or fall time of 118ns.

The WSS data registers may be loaded via the I²C interface or as BT.656 ancillary data. Table 8 illustrates the format of the WSS data as BT.656 ancillary data. The transfer should occur only once per field before the start of the SAV sequence of the line containing the WSS output.

When written via the I²C interface, the bytes may be written in any order but all three bytes of each enabled line must be written within one frame time for proper operation. If the registers are not updated, the encoder resends the previously loaded values.

The HMP8190/HMP8191 provides a write status bit for each WSS line. The encoder clears the write status bit to '0' when WSS is enabled and all bytes of the WSS data register have been written. The encoder sets the write status bit to '1' after it outputs the data, indicating the registers are ready to receive new data.

WSS information may be enabled for either line, both lines, or no lines. The WSS modes are summarized in Table 9.

HMP8190, HMP8191

TABLE 6. BT.656 ANCILLARY DATA FORMAT FOR CLOSED CAPTIONING DATA

PIXEL INPUT	P15	P14	P13	P12	P11	P10	P9	P8
Preamble 1	0	0	0	0	0	0	0	0
Preamble 2	1	1	1	1	1	1	1	1
Preamble 3	1	1	1	1	1	1	1	1
Data ID	ep#	ep	1	1	0	0	0	Line
Data Block Number	ep#	ep	0	0	0	0	0	1
Data Word Count	ep#	ep	0	0	0	0	0	1
Caption Register Byte 3	ep#	ep	0	0	bit 15	bit 14	bit 13	bit 12
Caption Register Byte 1	ep#	ep	0	0	bit 11	bit 10	bit 9	bit 8
Caption Register Byte 1	ep#	ep	0	0	bit 7	bit 6	bit 5	bit 4
Caption Register Byte 0	ep#	ep	0	0	bit 3	bit 2	bit 1	bit 0
CRC	P14#	X	X	X	X	X	X	X

NOTE:

The even parity (EP and EP#) bits are ignored.
 Line = Data Register Select: 0 = Line 21; 1 = 284.
 X = Don't Care.

TABLE 7. CLOSED CAPTIONING MODES

CLOSED CAPTIONING ENABLE BITS	OUTPUT LINE(S)	CAPTIONING REGISTER		WRITE STATUS BIT	
		284A 284B	21A 21B	284	21
00	None	Ignored	Ignored	Always 1	Always 1
01	21 (NTSC) 18 (M PAL) 22 (Other PAL)	Ignored	Caption Data	Always 1	0 = Loaded 1 = Output
10	284 (NTSC) 281 (M PAL) 335 (Other PAL)	Caption Data	Ignored	0 = Loaded 1 = Output	Always 1
11	21, 284 (NTSC) 18, 281 (M PAL) 22, 335 (Other PAL)	Caption Data	Caption Data	0 = Loaded 1 = Output	0 = Loaded 1 = Output

TABLE 8. BT.656 ANCILLARY DATA FORMAT FOR WIDESCREEN SIGNALLING DATA

PIXEL INPUT	P15	P14	P13	P12	P11	P10	P9	P8
Preamble 1	0	0	0	0	0	0	0	0
Preamble 2	1	1	1	1	1	1	1	1
Preamble 3	1	1	1	1	1	1	1	1
Data ID	ep#	ep	1	1	0	0	1	Line
Data Block Number	ep#	ep	0	0	0	0	0	1
Data Word Count	ep#	ep	0	0	0	0	1	0
WSS Data Nibble 3	ep#	ep	0	0	0	0	bit 13	bit 12
WSS Data Nibble 2	ep#	ep	0	0	bit 11	bit 10	bit 9	bit 8
WSS Data Nibble 1	ep#	ep	0	0	bit 7	bit 6	bit 5	bit 4
WSS Data Nibble 0	ep#	ep	0	0	bit 3	bit 2	bit 1	bit 0
WSS CRC Nibble 1	ep#	ep	0	0	0	0	bit 5	bit 4
WSS CRC Nibble 0	ep#	ep	0	0	bit 3	bit 2	bit 1	bit 0
Reserved	ep#	ep	0	0	0	0	0	0
Reserved	ep#	ep	0	0	0	0	0	0
CRC	P14#	X	X	X	X	X	X	X

NOTE:

The even parity (EP and EP#) bits are ignored.
 Line = Data Register Select: 0 = Line 20; 1 = 283.
 The WSS CRC data bits are ignored during PAL operation but must be included in the transfer.
 X = Don't Care.

HMP8190, HMP8191

TABLE 9. WIDESCREEN SIGNALLING MODES

WSS ENABLE BITS	OUTPUT LINE(S)	WSS REGISTERS		WRITE STATUS BIT	
		283A, 283B, CRC283	20A, 20B, CRC20	283	20
00	None	Ignored	Ignored	Always 1	Always 1
01	20 (NTSC) 17 (M PAL) 23 (Other PAL)	Ignored	WSS Data	Always 1	0 = Loaded 1 = Output
10	283 (NTSC) 280 (M PAL) 336 (Other PAL)	WSS Data	Ignored	0 = Loaded 1 = Output	Always 1
11	20, 283 (NTSC) 17, 280 (M PAL) 23, 336 (Other PAL)	WSS Data	WSS Data	0 = Loaded 1 = Output	0 = Loaded 1 = Output

NOTE: The CRC registers are always ignored during PAL operation.

TABLE 10. BT.656 ANCILLARY DATA FORMAT FOR PHINC DATA

PIXEL INPUT	P15	P14	P13	P12	P11	P10	P9	P8
Preamble 1	0	0	0	0	0	0	0	0
Preamble 2	1	1	1	1	1	1	1	1
Preamble 3	1	1	1	1	1	1	1	1
Data ID	EP#	EP	1	1	0	1	0	1
Data Block Number	EP#	EP	0	0	0	0	0	1
Data Word Count	EP#	EP	0	0	0	0	1	1
HPLL Increment (4 Nibbles)	EP#	EP	0	0	bit 15	bit 14	bit 13	bit 12
	EP#	EP	0	0	bit 11	bit 10	bit 9	bit 8
	EP#	EP	0	0	bit 7	bit 6	bit 5	bit 4
	EP#	EP	0	0	bit 3	bit 2	bit 1	bit 0
FSCPLL Increment (8 Nibbles)s	EP#	EP	PSW	0	bit 31	bit 30	bit 29	bit 28
	EP#	EP	F2	F1	bit 27	bit 26	bit 25	bit 24
	...							
	EP#	EP	0	0	bit 7	bit 6	bit 5	bit 4
	EP#	EP	0	0	bit 3	bit 2	bit 1	bit 0
CRC	P14#	X	X	X	X	X	X	X

NOTE:

The even parity (EP and EP#) bits are ignored.

HPLL, PSW, F2, and F1 are ignored.

X = Don't Care.

Macrovision

The HMP8191 provides the copy protection system specified by the Macrovision Antitaping Process for Digital Platforms document, revision 7.01, September 6, 1996.

The device is protected by U.S. patent numbers 4,631,603, 4,577,216, and 4,819,098 and other intellectual property rights. The use of Macrovision's copy protection technology in the device must be authorized by Macrovision and is intended for home and other limited pay-per-view uses only, unless otherwise authorized in writing by Macrovision. Reverse engineering or disassembly is prohibited.

Additional information about Macrovision in the HMP8191 is available to Macrovision Authorized Buyers only. Tech Brief 359, HMP8171/HMP8173 Macrovision Registers provides the details required. Although written for the HMP8171/HMP813 encoders, the tech brief also applies to the HMP8191.

Analog Outputs

The HMP8190/HMP8191 converts the video data into analog signals using three 10-bit DACs running at the CLK2 rate. The DACs output a current proportional to the digital data. The full scale output current is determined by the reference voltage VREF and an external resistor RSET. The full scale output current is given by:

$$I_{\text{FULLSCALE}}(\text{mA}) = 3.9V_{\text{REF}}(\text{V})/R_{\text{SET}}(\text{k}\Omega) \quad (\text{EQ. 1})$$

VREF must be chosen such that it is within the part's operating range; RSET must be chosen such that the maximum output current is not exceeded. These limits are listed in the Electrical Specifications section below.

If the VREF pin is not connected, the HMP8190/HMP8191 uses the internal reference voltage. Otherwise, the applied voltage overdrives the internal reference. If an external reference is used, it must be decoupled from any power supply noise. An example external reference circuit is shown in the Applications section.

The HMP8190/HMP8191 generates 1V_{P-P} nominal video signals across 37.5Ω loads, corresponding to doubly terminated 75Ω lines. The encoder may also drive larger loads. The full scale output current and load must be chosen such that the maximum output voltage is not exceeded.

The HMP8190/HMP8191 provides composite with S-video output mode. The encoder outputs luminance, modulated chrominance, and composite video signals. All three outputs are time aligned.

Output DAC Filtering

Since the DACs run at 2x the pixel sample rate, the sin(x)/x rolloff of the outputs is greatly reduced, and there are fewer high frequency artifacts in the output spectrum. This allows using simple analog output filters. The analog output filter should be flat to Fs/4 and have good rejection at 3Fs/4. Example filters are shown in the Applications section.

Power Down Modes

To reduce power dissipation, any of the four output DACs may be turned off. Each DAC has an independent enable bit. Each output may be disabled in the host control register.

When the power down mode is enabled, all of the DACs and internal voltage reference are powered down (forcing their outputs to zero) and the data pipeline registers are disabled. The host processor may still read from and write to the internal control registers.

Host Interfaces

Reset

The HMP8190/HMP8191 resets to its default operating mode on power up, when the reset pin is asserted for at least four CLK cycles, or when the software reset bit of the host control register is set. During the reset cycle, the encoder returns its internal registers to their reset state and deactivates the I²C interface. After a reset cycle, the internal registers maintain their default values until overwritten via the I²C bus.

I²C Interface

The HMP8190/HMP8191 provides a standard I²C interface and supports fast-mode (up to 400 Kbps) transfers. The device acts as a slave for receiving and transmitting data only. It will not respond to general calls or initiate a transfer. The encoder's slave address is either 0100 000x_B when the SA input pin is low or 0100 001x_B when it is high. (The 'x' bit in the address is the I²C read flag.)

The I²C interface consists of the SDA and SCL pins. When the interface is not active, SCL and SDA must be pulled high using external 4-6kΩ pull-up resistors. The I²C clock and data timing is shown in Figures 10 and 11.

During I²C write cycles, the first data byte after the slave address specifies the sub address, and is written into the address register. Only the seven LSBs of the subaddress are used; the MSB is ignored. Any remaining data bytes in the I²C write cycle are written to the control registers, beginning with the register specified by the address register. The 7-bit address register is incremented after each data byte in the I²C write cycle. Data written to reserved bits within registers or reserved registers is ignored.

During I²C read cycles, data from the control register specified by the address register is output. The address register is incremented after each data byte in the I²C read cycle. Reserved bits within registers return a value of "0". Reserved registers return a value of 00_H.

The HMP8190/HMP8191's operating modes are determined by the contents of internal registers which are accessed via the I²C interface. All internal registers may be written or read by the host processor at any time. However, some of the bits and words are read only or reserved and data written to these bits is ignored.

Table 11 lists the HMP8190/HMP8191's internal registers. Their bit descriptions are listed in Tables 12 through 43.

TABLE 11. CONTROL REGISTER NAMES

SUB ADDRESS (HEX)	CONTROL REGISTER	RESET CONDITION
00	product ID	-
01	output format	00H
02	input format	06H
03	video processing	80H
04	timing I/O 1	00H
05	timing I/O 2	00H
06	VBI data enable	00H
07	VBI data input	00H
08-0D	reserved	-
0E	host control 1	1EH
0F	host control 2	00H
10	caption_21A	80H
11	caption_21B	80H
12	caption_284A	80H
13	caption_284B	80H
14	WSS_20A	00H
15	WSS_20B	00H
16	WSS_283A	00H
17	WSS_283B	00H
18	CRC_20	3FH
19	CRC_283	3FH
1A-1F	reserved	-
20	start h_blank low	4AH
21	start h_blank high	03H
22	end h_blank	7AH
23	start v_blank low	03H
24	start v_blank high	01H
25	end v_blank	13H
26	field control 1	00H
27	field control 2	00H
28-2F	reserved	-
30-6A	test and unused	-
6B-6F	phase increment	-
70-7F	test and unused	-

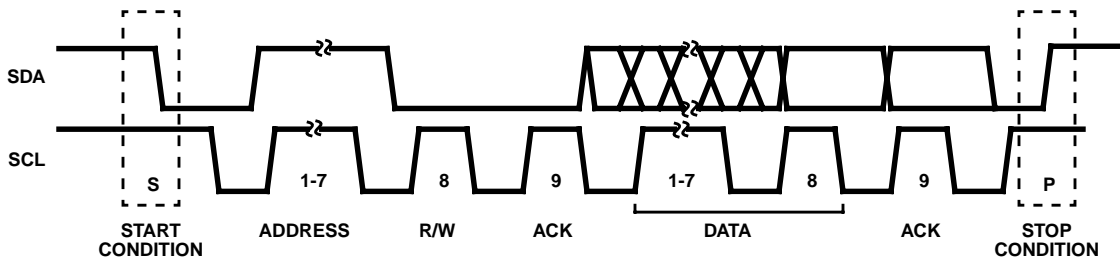
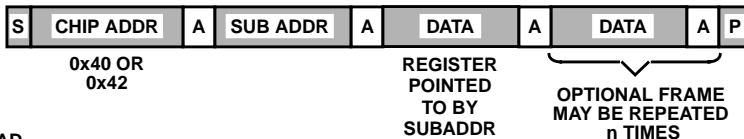

FIGURE 10. I²C SERIAL TIMING FLOW

DATA WRITE



S = START CYCLE
P = STOP CYCLE
A = ACKNOWLEDGE
NA = NO ACKNOWLEDGE

DATA READ

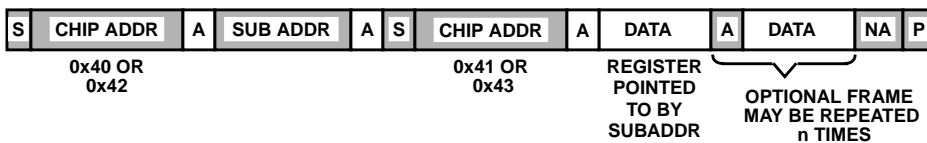

■ FROM MASTER
□ FROM ENCODER

FIGURE 11. REGISTER WRITE PROGRAMMING FLOW

HMP8190, HMP8191

TABLE 12. PRODUCT ID REGISTER

SUB ADDRESS = 00 _H			
BIT NUMBER	FUNCTION	DESCRIPTION	RESET STATE
7-0	Product ID	This 8-bit register specifies the last two digits of the product number. It is a read-only register. Data written to it is ignored.	90 _H 91 _H

TABLE 13. OUTPUT FORMAT REGISTER

SUB ADDRESS = 01 _H			
BIT NUMBER	FUNCTION	DESCRIPTION	RESET STATE
7-5	Video Timing Standard	000 = (M) NTSC 001 = reserved 010 = (B, D, G, H, I) PAL 011 = (M) PAL 100 = (N) PAL 101 = (NC) PAL 110 = Reserved 111 = Reserved	000 _B
4-3	Reserved		00 _B
2-0	NTSC / PAL Setup Select	These bits specify the blanking pedestal during active video, from 0 IRE ("000") to 7.5 IRE ("111"). Typically, these bits should be a "111" during (M) NTSC and (M, N) PAL operation. Otherwise, they should be a "000". These bits do not affect the analog RGB or YUV outputs.	111 _B

TABLE 14. INPUT FORMAT REGISTER

SUB ADDRESS = 02 _H			
BIT NUMBER	FUNCTION	DESCRIPTION	RESET STATE
7-5	Input Format	000 = 16-bit 4:2:2 YCbCr 001 = 8-bit 4:2:2 YCbCr 010 = 8-bit BT.656 011 = Reserved 100 = Reserved 101 = Reserved 110 = Reserved 111 = Reserved	000 _B
4 - 0	Reserved		00000 _B

TABLE 15. VIDEO PROCESSING REGISTER

SUB ADDRESS = 03 _H			
BIT NUMBER	FUNCTION	DESCRIPTION	RESET STATE
7	Luminance Processing	0 = None 1 = Y Lowpass filtering enabled	1 _B
6	Composite Video Limiting	0 = None 1 = Lower limit of composite active video is about half the sync height	0 _B
5	SCH Phase Mode	0 = Never reset SCH phase 1 = Reset SCH phase every 4 (NTSC) or 8 (PAL) fields	1 _B
4-0	Reserved		0 0000 _B

HMP8190, HMP8191

TABLE 16. TIMING I/O REGISTER #1

SUB ADDRESS = 04 _H			
BIT NUMBER	FUNCTION	DESCRIPTION	RESET STATE
7	BLANK Timing Select	This bit is ignored unless $\overline{\text{BLANK}}$ is configured to be an output. 0 = Data for the first active pixel of the scan line must arrive the CLK cycle after the encoder negates BLANK. 1 = Data for the first active pixel of the scan line must arrive immediately after the encoder negates BLANK.	0 _B
6	Reserved		0 _B
5	$\overline{\text{BLANK}}$ Output Control	0 = $\overline{\text{BLANK}}$ is an input 1 = $\overline{\text{BLANK}}$ is an output	0 _B
4	$\overline{\text{BLANK}}$ Polarity	0 = Active low (low during blanking) 1 = Active high (high during blanking)	0 _B
3	$\overline{\text{HSYNC}}$ and $\overline{\text{VSYNC}}$ Output Control	0 = $\overline{\text{HSYNC}}$ and $\overline{\text{VSYNC}}$ are inputs 1 = $\overline{\text{HSYNC}}$ and $\overline{\text{VSYNC}}$ are outputs	0 _B
2	$\overline{\text{HSYNC}}$ Polarity	0 = Active low (low during horizontal sync) 1 = Active high (high during horizontal sync)	0 _B
1	$\overline{\text{VSYNC}}$ Polarity	0 = Active low (low during vertical sync) 1 = Active high (high during vertical sync)	0 _B
0	FIELD Polarity	0 = Active low (low during odd fields) 1 = Active high (high during odd fields)	0 _B

TABLE 17. TIMING I/O REGISTER #2

SUB ADDRESS = 05 _H			
BIT NUMBER	FUNCTION	DESCRIPTION	RESET STATE
7-6	Reserved		00 _B
5	CLK Polarity Control	0 = Inputs are sampled when CLK is low (see Table 2). 1 = Inputs are sampled when CLK is high.	0 _B
4	CLK Output Control	0 = CLK is an input 1 = CLK is an output	0 _B
3	Aspect Ratio Mode	This bit must be set to "0" during BT.656 input mode. 0 = Rectangular (BT.601) pixels 1 = Square pixels	0 _B
2	Reserved		0 _B
1-0	Subcarrier PHINC Select	Selects the source of the color subcarrier NCO phase increment value. 00 = Internal (fixed) data. 01 = Reserved 10 = BT.656 RTCI ancillary data 11 = I ² C interface PHINC register	00 _B

HMP8190, HMP8191

TABLE 18. AUXILIARY DATA ENABLE REGISTER

SUB ADDRESS = 06 _H			
BIT NUMBER	FUNCTION	DESCRIPTION	RESET STATE
7-6	Closed Captioning Enable	00 = Closed caption disabled 01 = Closed caption enabled for odd fields: line 21 for NTSC, line 18 for (M) PAL, or line 22 for (B, D, G, H, I, N, NC) PAL 10 = Closed caption enabled for even fields: line 284 for NTSC, line 281 for (M) PAL, or line 335 for (B, D, G, H, I, N, NC) PAL 11 = Closed caption enabled for both odd and even fields	00 _B
5-4	WSS Enable	00 = WSS disabled 01 = WSS enabled for odd fields: line 20 for NTSC; line 17 for (M) PAL, or line 23 for (B, D, G, H, I, N, NC) PAL 10 = WSS enabled for even fields: line 283 for NTSC, line 280 for (M) PAL, or line 336 for (B, D, G, H, I, N, NC) PAL 11 = WSS enabled for both odd and even fields	00 _B
3-0	Reserved		0000 _B

TABLE 19. VBI DATA INPUT REGISTER

SUB ADDRESS = 07 _H			
BIT NUMBER	FUNCTION	DESCRIPTION	RESET STATE
7	Closed Caption Line 21 BT.656 Enable	Setting this bit enables BT.656 ancillary data to be written into the closed caption line 21 data registers. It is ignored unless in the BT.656 input mode. 0 = Ignore BT.656 ancillary data 1 = Use BT.656 ancillary data	0 _B
6	Closed Caption Line 284 BT.656 Enable	Setting this bit enables BT.656 ancillary data to be written into the closed caption line 284 data registers. It is ignored unless in the BT.656 input mode. 0 = Ignore BT.656 ancillary data 1 = Use BT.656 ancillary data	0 _B
5	WSS Line 20 BT.656 Enable	Setting this bit enables BT.656 ancillary data to be written into the WSS line 20 data registers. It is ignored unless in the BT.656 input mode. 0 = Ignore BT.656 ancillary data 1 = Use BT.656 ancillary data	0 _B
4	WSS Line 283 BT.656 Enable	Setting this bit enables BT.656 ancillary data to be written into the WSS line 283 data registers. It is ignored unless in the BT.656 input mode. 0 = Ignore BT.656 ancillary data 1 = Use BT.656 ancillary data	0 _B
3-0	Reserved		0000 _B

TABLE 20. HOST CONTROL REGISTER 1

SUB ADDRESS = 0E _H			
BIT NUMBER	FUNCTION	DESCRIPTION	RESET STATE
7-5	Reserved		000 _B
4	Closed Caption Line 21 Write Status	0 = Caption_21A and Caption_21B data registers contain unused data 1 = Data has been output, host processor may now write to the registers	1 _B
3	Closed Caption Line 284 Write Status	0 = Caption_284A and Caption_284B data registers contain unused data 1 = Data has been output, host processor may now write to the registers	1 _B
2	WSS Line 20 Write Status	0 = WSS_20A, WSS_20B, CRC_20A, and CRC_20B data registers contain unused data 1 = Data has been output, host processor may now write to the registers	1 _B

HMP8190, HMP8191

TABLE 20. HOST CONTROL REGISTER 1 (Continued)

SUB ADDRESS = 0E _H			
BIT NUMBER	FUNCTION	DESCRIPTION	RESET STATE
1	WSS Line 283 Write Status	0 = WSS_283A and WSS_283B data registers contain unused data 1 = Data has been output, host processor may now write to the registers	1 _B
0	Reserved		0 _B

TABLE 21. HOST CONTROL REGISTER 2

SUB ADDRESS = 0F _H			
BIT NUMBER	FUNCTION	DESCRIPTION	RESET STATE
7	Software Reset	Setting this bit to "1" initiates a software reset. It is automatically reset to a "0" after the reset sequence is complete.	0 _B
6	General Power Down	This bit powers down all DAC outputs and most of the digital circuitry. 0 = Normal operation 1 = Power down mode	0 _B
5	Power Down NTSC/PAL 1 Output DAC	This bit powers down only the NTSC/PAL 1 DAC output. 0 = Normal operation 1 = Power down mode	0 _B
4	Reserved		0 _B
3	Power Down Y Output DAC	This bit powers down only the Y DAC output. 0 = Normal operation 1 = Power down mode	0 _B
2	Power Down C Output DAC	This bit powers down only the C DAC output. 0 = Normal operation 1 = Power down mode	0 _B
1-0	Reserved		00 _B

TABLE 22. CLOSED CAPTION_21A DATA REGISTER

SUB ADDRESS = 10 _H			
BIT NUMBER	FUNCTION	DESCRIPTION	RESET STATE
7-0	Line 21 Caption LSB Data	This register is cascaded with the closed caption_21B data register and they are read out serially as 16 bits during line 18, 21, or 22 if line 21 captioning is enabled. Bit D0 of the 21A data register is shifted out first.	80 _H

TABLE 23. CLOSED CAPTION_21B DATA REGISTER

SUB ADDRESS = 11 _H			
BIT NUMBER	FUNCTION	DESCRIPTION	RESET STATE
7-0	Line 21 Caption MSB Data	This register is cascaded with the closed caption_21A data register and they are read out serially as 16 bits during line 18, 21, or 22 if line 21 captioning is enabled. Bit D0 of the 21A data register is shifted out first.	80 _H

HMP8190, HMP8191

TABLE 24. CLOSED CAPTION_284A DATA REGISTER

SUB ADDRESS = 12 _H			
BIT NUMBER	FUNCTION	DESCRIPTION	RESET STATE
7-0	Line 284 Caption LSB Data	This register is cascaded with the closed caption_284B data register and they are read out serially as 16 bits during line 281, 284, or 335 if line 284 captioning is enabled. Bit D0 of the 284A data register is shifted out first.	80 _H

TABLE 25. CLOSED CAPTION_284B DATA REGISTER

SUB ADDRESS = 13 _H			
BIT NUMBER	FUNCTION	DESCRIPTION	RESET STATE
7-0	Line 284 Caption MSB Data	This register is cascaded with the closed caption_284A data register and they are read out serially as 16 bits during line 281, 284, or 335 if line 284 captioning is enabled. Bit D0 of the 284A data register is shifted out first.	80 _H

TABLE 26. WSS_20A DATA REGISTER

SUB ADDRESS = 14 _H			
BIT NUMBER	FUNCTION	DESCRIPTION	RESET STATE
7-0	Line 20 WSS LSB Data	This register is cascaded with the WSS_20B data register and they are read out serially as 14 bits during line 17, 20, or 23 if WSS is enabled. Bit D0 of the WSS_20A data register is shifted out first.	00 _H

TABLE 27. WSS_20B DATA REGISTER

SUB ADDRESS = 15 _H			
BIT NUMBER	FUNCTION	DESCRIPTION	RESET STATE
7 - 6	Reserved		00 _B
5 - 0	Line 20 WSS MSB Data	This register is cascaded with the WSS_20A data register and they are read out serially as 14 bits during line 17, 20, or 23 if WSS is enabled. Bit D0 of the WSS_20A data register is shifted out first.	000000 _B

TABLE 28. WSS_283A DATA REGISTER

SUB ADDRESS = 16 _H			
BIT NUMBER	FUNCTION	DESCRIPTION	RESET STATE
7-0	Line 283 WSS LSB Data	This register is cascaded with the WSS_283B data register and they are read out serially as 14 bits during line 280, 283, or 336 if WSS is enabled. Bit D0 of the WSS_283A data register is shifted out first.	00 _H

TABLE 29. WSS_283B DATA REGISTER

SUB ADDRESS = 17 _H			
BIT NUMBER	FUNCTION	DESCRIPTION	RESET STATE
7 - 6	Reserved		00 _B
5 - 0	Line 283 WSS MSB Data	This register is cascaded with the WSS_283A data register and they are read out serially as 14 bits during line 280, 283, or 336 if WSS is enabled. Bit D0 of the WSS_283A data register is shifted out first.	000000 _B

HMP8190, HMP8191

TABLE 30. CRC_20 REGISTER

SUB ADDRESS = 18 _H			
BIT NUMBER	FUNCTION	DESCRIPTION	RESET STATE
7-6	Reserved		00 _B
5-0	Line 20 WSS CRC Data	This register is read out serially after the 14 bits of NTSC WSS data, if WSS is enabled. It is ignored during PAL WSS operation. Bit D0 is shifted out first.	111111 _B

TABLE 31. CRC_283 REGISTER

SUB ADDRESS = 19 _H			
BIT NUMBER	FUNCTION	DESCRIPTION	RESET STATE
7-6	Reserved		00 _B
5-0	Line 283 WSS CRC Data	This register is read out serially after the 14 bits of NTSC WSS data, if WSS is enabled. It is ignored during PAL WSS operation. Bit D0 is shifted out first.	111111 _B

TABLE 32. START H_BLANK LOW REGISTER

SUB ADDRESS = 20 _H			
BIT NUMBER	FUNCTION	DESCRIPTION	RESET STATE
7-0	LSB Assert $\overline{\text{BLANK}}$ Output Signal (Horizontal)	This 8-bit register is cascaded with Start H_Blank High Register to form a 10-bit start_horizontal_blank register. It specifies the horizontal count (in 1x clock cycles) at which to start ignoring pixel data each scan line. The leading edge of $\overline{\text{HSYNC}}$ is count 020 _H . This register is ignored unless $\overline{\text{BLANK}}$ is configured as an output.	4A _H

TABLE 33. START H_BLANK HIGH REGISTER

SUB ADDRESS = 21 _H			
BIT NUMBER	FUNCTION	DESCRIPTION	RESET STATE
7-2	Reserved		000000 _B
1-0	MSB Assert $\overline{\text{BLANK}}$ Output Signal (Horizontal)	This 2-bit register is cascaded with Start H_Blank Low Register to form a 10-bit start_horizontal_blank register. It specifies the horizontal count (in 1x clock cycles) at which to start ignoring pixel data each scan line. The leading edge of $\overline{\text{HSYNC}}$ is count 020 _H . This register is ignored unless $\overline{\text{BLANK}}$ is configured as an output.	11 _B

TABLE 34. END H_BLANK REGISTER

SUB ADDRESS = 22 _H			
BIT NUMBER	FUNCTION	DESCRIPTION	RESET STATE
7-0	Negate $\overline{\text{BLANK}}$ Output Signal (Horizontal)	This 8-bit register specifies the horizontal count (in 1x clock cycles) at which to start inputting pixel data each scan line. The leading edge of $\overline{\text{HSYNC}}$ is count 000 _H . This register is ignored unless $\overline{\text{BLANK}}$ is configured as an output.	7A _H

HMP8190, HMP8191

TABLE 35. START V_BLANK LOW REGISTER

SUB ADDRESS = 23 _H			
BIT NUMBER	FUNCTION	DESCRIPTION	RESET STATE
7-0	LSB Assert $\overline{\text{BLANK}}$ Output Signal (Vertical)	This 8-bit register is cascaded with Start V_Blank High Register to form a 9-bit start_vertical_blank register. During normal operation, it specifies the line number (n) to start ignoring pixel input data (and what line number to start blanking the output video) each odd field; for even fields, it occurs on line (n + 262) or (n + 313). The leading edge of $\overline{\text{VSYNC}}$ at the start of an odd field is count 000 _H (note that this does not follow standard NTSC or PAL line numbering). This register is ignored unless $\overline{\text{BLANK}}$ is configured as an output.	03 _H

TABLE 36. START V_BLANK HIGH REGISTER

SUB ADDRESS = 24 _H			
BIT NUMBER	FUNCTION	DESCRIPTION	RESET STATE
7-1	Reserved		0000000 _B
0	MSB Assert $\overline{\text{BLANK}}$ Output Signal (Vertical)	This 1-bit register is cascaded with Start V_Blank Low Register to form a 9-bit start_vertical_blank register. This register is ignored unless $\overline{\text{BLANK}}$ is configured as an output.	1 _B

TABLE 37. END V_BLANK REGISTER

SUB ADDRESS = 25 _H			
BIT NUMBER	FUNCTION	DESCRIPTION	RESET STATE
7-0	Negate $\overline{\text{BLANK}}$ Output Signal (Vertical)	During normal operation, this 8-bit register specifies the line number (n) to start inputting pixel input data (and what line number to start generating active output video) each odd field; for even fields, it occurs on line (n + 262) or (n + 313). The leading edge of $\overline{\text{VSYNC}}$ at the start of an odd field is count 000 _H (note that this does not follow standard NTSC or PAL line numbering). This register is ignored unless $\overline{\text{BLANK}}$ is configured as an output.	13 _H

TABLE 38. FIELD CONTROL REGISTER 1

SUB ADDRESS = 26 _H			
BIT NUMBER	FUNCTION	DESCRIPTION	RESET STATE
7-0	Field Detect Window Size Low	This 8-bit register is cascaded with Field Detect Window Size High to form a 9-bit Field Detect Window Size value. The value specifies the number of 1x clock cycles in the detection window before and after the selected edge of $\overline{\text{VSYNC}}$. It may range from 0 to 511. If the leading edge of $\overline{\text{HSYNC}}$ occurs within the window, it is the start of an odd or even field, as specified by the FIELD Detect Select bit. This register is ignored unless $\overline{\text{HSYNC}}$ and $\overline{\text{VSYNC}}$ are configured as inputs.	80 _H

TABLE 39. FIELD CONTROL REGISTER 2

SUB ADDRESS = 27 _H			
BIT NUMBER	FUNCTION	DESCRIPTION	RESET STATE
7-4	Half Line Count Reset Value	These bits specify the value to load to the vertical half line counter when the selected edge of $\overline{\text{VSYNC}}$. The value is ignored when $\overline{\text{HSYNC}}$ and $\overline{\text{VSYNC}}$ are configured as outputs.	00000 _B
2	$\overline{\text{VSYNC}}$ Edge Select	This bit specifies whether the encoder uses the leading or trailing edge of $\overline{\text{VSYNC}}$ to determine the field and to reset the half line counter. It is ignored unless $\overline{\text{HSYNC}}$ and $\overline{\text{VSYNC}}$ are configured as inputs. 0 = leading edge 1 = trailing edge	0 _B

HMP8190, HMP8191

TABLE 39. FIELD CONTROL REGISTER 2

SUB ADDRESS = 27 _H			
BIT NUMBER	FUNCTION	DESCRIPTION	RESET STATE
1	FIELD Detect Select	This bit specifies whether an odd or even field is starting when the leading edge of $\overline{\text{HSYNC}}$ occurs within the FIELD Detect Window. It is ignored unless $\overline{\text{HSYNC}}$ and $\overline{\text{VSYNC}}$ are configured as inputs. 0 = odd field 1 = even field	0 _B
0	Field Detect Window Size High	This bit is cascaded with Field Detect Window Size Low to form a 9-bit Field Detect Window Size value. This bit is ignored unless $\overline{\text{HSYNC}}$ and $\overline{\text{VSYNC}}$ are configured as inputs.	0 _B

TABLE 40. PHASE INCREMENT REGISTER 0

SUB ADDRESS = 6B _H			
BIT NUMBER	FUNCTION	DESCRIPTION	RESET STATE
7-0	PHINC 0 (LSB)	The 8-bit registers PHINC 0–3 are cascaded together to form a 32-bit PHINC value. The PHINC value is the phase increment value of the color subcarrier generation NCO. When the BT.656 ancillary data is selected as the PHINC source, the PHINC registers may be read to determine the last PHINC value loaded via the selected interface.	00 _H

TABLE 41. PHASE INCREMENT REGISTER 1

SUB ADDRESS = 6C _H			
BIT NUMBER	FUNCTION	DESCRIPTION	RESET STATE
7-0	PHINC 1	The 8-bit registers PHINC 0–3 are cascaded together to form a 32-bit PHINC value. The PHINC value is the phase increment value of the color subcarrier generation NCO. When the BT.656 ancillary data is selected as the PHINC source, the PHINC registers may be read to determine the last PHINC value loaded via the selected interface.	00 _H

TABLE 42. PHASE INCREMENT REGISTER 2

SUB ADDRESS = 6D _H			
BIT NUMBER	FUNCTION	DESCRIPTION	RESET STATE
7-0	PHINC 2	The 8-bit registers PHINC 0–3 are cascaded together to form a 32-bit PHINC value. The PHINC value is the phase increment value of the color subcarrier generation NCO. When the BT.656 ancillary data is selected as the PHINC source, the PHINC registers may be read to determine the last PHINC value loaded via the selected interface.	00 _H

TABLE 43. PHASE INCREMENT REGISTER 1

SUB ADDRESS = 6E _H			
BIT NUMBER	FUNCTION	DESCRIPTION	RESET STATE
7-0	PHINC 3 (MSB)	The 8-bit registers PHINC 0–3 are cascaded together to form a 32-bit PHINC value. The PHINC value is the phase increment value of the color subcarrier generation NCO. When the BT.656 ancillary data is selected as the PHINC source, the PHINC registers may be read to determine the last PHINC value loaded via the selected interface.	00 _H

HMP8190, HMP8191

Pinout

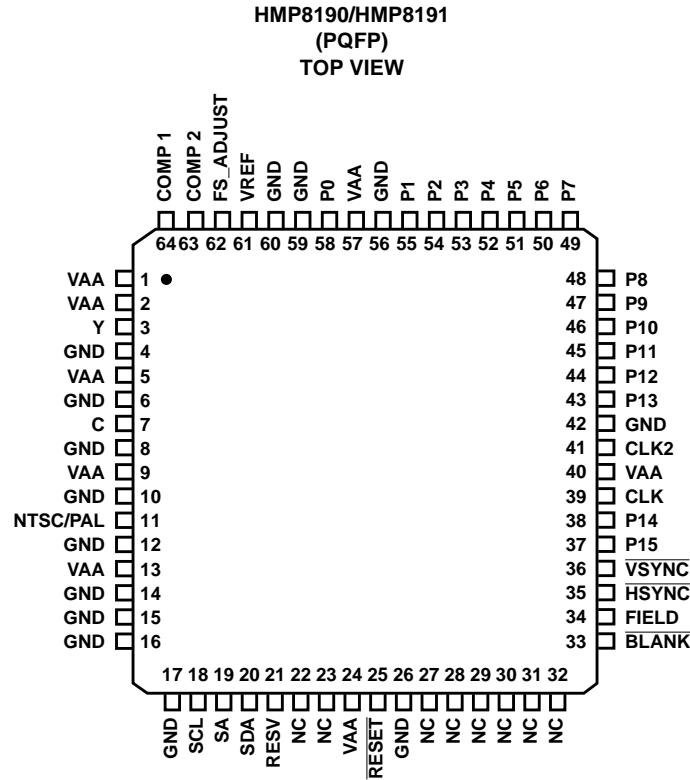

Pin Descriptions

PIN NAME	PIN NUMBER	INPUT/OUTPUT	DESCRIPTION
P0-P15	58, 55-43, 38, 37	I	Pixel Input Pins. See Table 1. Any pixel inputs not used should be connected to GND.
NC	32-27, 23, 22	I	No Connect Pins. These pins are not used. They may be left floating or may be connected to GND.
RESV	21	I	This pin is reserved and should be connected to GND.
FIELD	34	O	FIELD Output. The field output indicates that the encoder is outputting the odd or even video field. The polarity of FIELD is programmable.
$\overline{\text{HSYNC}}$	35	I/O	Horizontal Sync Input/Output. As an input, this pin must be asserted during the horizontal sync intervals. If it occurs early, the line time will be shortened. If it occurs late, the line time will be lengthened by holding the outputs at the front porch level. As an output, it is asserted during the horizontal sync intervals. The polarity of $\overline{\text{HSYNC}}$ is programmable. If not driven, the circuit for this pin should include a 4-12k Ω pull up resistor connected to VAA.
$\overline{\text{VSYNC}}$	36	I/O	Vertical Sync Input/Output. As an input, this pin must be asserted during the vertical sync intervals. If it occurs early, the field time will be shortened. If it occurs late, the field time will be lengthened by holding the outputs at the blanking level. As an output, it is asserted during the vertical sync intervals. The polarity of $\overline{\text{VSYNC}}$ is programmable. If not driven, the circuit for this pin should include a 4-12k Ω pull up resistor connected to VAA.
$\overline{\text{BLANK}}$	33	I/O	Composite Blanking Input/Output. As an input, this pin must be asserted during the horizontal and vertical blanking intervals. As an output, it is asserted during the horizontal and vertical blanking intervals. The polarity of $\overline{\text{BLANK}}$ is programmable. If not driven, the circuit for this pin should include a 4-12k Ω pull up resistor connected to VAA.
CLK	39	I/O	1x Pixel Clock Input/Output. As an input, this clock must be free-running and synchronous to the clock signal on the CLK2 pin. As an output, this pin may drive a maximum of one LS TTL load. CLK is generated by dividing CLK2 by two or four, depending on the mode. If not driven, the circuit for this pin should include a 4-12k Ω pull up resistor connected to VAA.
CLK2	41	I	2x Pixel Clock Input. This clock must be a continuous, free-running clock.

Pin Descriptions (Continued)

PIN NAME	PIN NUMBER	INPUT/ OUTPUT	DESCRIPTION
SCL	18	I	I ² C Interface Clock Input. The circuit for this pin should include a 4-6kΩ pull-up resistor connected to VAA.
SA	19	I	I ² C Interface Address Select Input.
SDA	20	I/O	I ² C Interface Data Input/Output. The circuit for this pin should include a 4-6kΩ pull-up resistor connected to VAA.
RESET	25	I	Reset Control Input. A logical zero for a minimum of four CLK cycles resets the device. RESET must be a logical one for normal operation.
Y	3	O	Luminance Analog Current Output. This output contains luminance video, sync, blanking, and information. It is capable of driving a 37.5Ω load. If not used, it should be connected to GND and the DAC should be powered down.
C	7	O	Chrominance Analog Current Output. This output contains chrominance video, and blanking information. It is capable of driving a 37.5Ω load. If not used, it should be connected to GND and the DAC should be powered down.
NTSC/PAL	11	O	Composite Video Analog Current Output. This output contains composite video, sync, blanking, and information. It is capable of driving a 37.5Ω load. If not used, it should be connected to GND and the DAC should be powered down.
VREF	61	I/O	Voltage Reference. An optional external 1.235V reference may be used to drive this pin. If left floating, the internal voltage reference is used.
FS_ADJUST	62		Full Scale Adjust Control. A resistor (RSET) connected between this pin and GND sets the full-scale output current of each of the DACs.
COMP 1	64		Compensation Pin. A 0.1μF ceramic chip capacitor should be connected between this pin and VAA, as close to the device as possible.
COMP 2	63		Compensation Pin. A 0.1μF ceramic chip capacitor should be connected between this pin and VAA as close to the device as possible.
VAA			+5V Power. A 0.1μF ceramic capacitor, in parallel with a 0.01μF chip capacitor, should be used between each group of VAA pins and GND. These should be as close to the device as possible.
GND			Ground.

HMP8190, HMP8191

Absolute Maximum Ratings

Supply Voltage (V_{AA} to GND) 6.0V
 All Signal Pins (GND – 0.5V) to (V_{AA} + 0.5V)
 ESD Classification Class 2

Operating Conditions

Temperature Range 0°C to 70°C

Thermal Information

Thermal Resistance (Typical, Note 4) θ_{JA} °C/W
 PQFP Package 55
 Maximum Junction Temperature 150°C
 Maximum Storage Temperature Range -65°C to 150°C
 Vapor Phase Soldering, 1 Minute 220°C
 (PQFP - Lead Tips Only)

CAUTION: Stresses above those listed in the “Absolute Maximum Ratings” may cause permanent damage to the device. This is a stress only rating and operation of the device at these or any other conditions above those indicated in the operation section of this specification is not implied.

NOTE:

- θ_{JA} is measured with the component mounted on an evaluation printed circuit board in free air. Dissipation rating assumes that the device is mounted with all its leads soldered to the PCB.

Electrical Specifications $V_{AA} = +5V \pm 5\%$, RSET = 133 Ω , VREF Unconnected, $T_A = 25^\circ\text{C}$, Unless Otherwise Specified

PARAMETER	TEST CONDITION	MIN	TYP	MAX	UNITS
DC PARAMETERS, DIGITAL INPUTS EXCEPT CLK2, SDA, SCL					
Input Logic Low Voltage, V_{IL}		-	-	0.8	V
Input Logic High Voltage, V_{IH}		2.0	-	-	V
Input Logic Low Current, I_{IL}	$V_{IN} = 0.0V$	-	-	-10	μA
Input Logic High Current, I_{IH}	$V_{IN} = V_{AA}$	-	-	10	μA
Input Capacitance, C_{IN}		-	8	-	pF
DC PARAMETERS, CLK2 INPUT					
Input Logic Low Voltage, V_{IL}		-	-	$0.3 \times V_{AA}$	V
Input Logic High Voltage, V_{IH}		$0.7 \times V_{AA}$	-	-	V
Input Logic Low Current, I_{IL}	$V_{IN} = 0.0V$	-	-	-10	μA
Input Logic High Current, I_{IH}	$V_{IN} = V_{AA}$	-	-	10	μA
Input Capacitance, C_{IN}		-	8	-	pF
DC PARAMETERS, SDA AND SCL INPUTS					
Input Logic Low Voltage, V_{IL}		-	-	$0.3 \times V_{AA}$	V
Input Logic High Voltage, V_{IH}		$0.7 \times V_{AA}$	-	-	V
Input Current, I_I	$V_{IN} = 0.0V$ to V_{AA}	-	-	± 10	μA
Input Capacitance, C_{IN}		-	8	-	pF
DC PARAMETERS, DIGITAL OUTPUTS, EXCEPT SDA					
Output Logic Low Voltage, V_{OL}	$I_{OL} = 2\text{mA}$	-	-	0.4	V
Output Logic High Voltage, V_{OH}	$I_{OH} = -2\text{mA}$	2.4	-	-	V
Output Capacitance, C_{OUT}		-	8	-	pF
DC PARAMETERS, SDA OUTPUT					
Output Logic Low Voltage, V_{OL}	$I_{OL} = 3\text{mA}$	-	-	0.4	V
Output Capacitance, C_{OUT}		-	8	-	pF
DC PARAMETERS, ANALOG OUTPUTS					
DAC Resolution		-	10	-	Bits
Integral Nonlinearity, INL		-	0.5	± 2	LSB
Differential Nonlinearity, DNL		-	0.5	± 1	LSB
Output Current		-	-	34.8	mA
Output Impedance	$I_{OUT} = 0\text{mA}$	-	2M	-	Ω
	$I_{OUT} = 34\text{mA}$	-	300K	-	Ω
Output Capacitance	$I_{OUT} = 0\text{mA}$, CLK = 13.5MHz	-	15	-	pF
Output Compliance Range		0	-	1.4	V
Video Level Error	(Note 5)	-	-	-	-
Internal Voltage Reference	VREF unconnected, RSET = 133 Ω	-	-	± 10	%

HMP8190, HMP8191

Electrical Specifications $V_{AA} = +5V \pm 5\%$, RSET = 133 Ω , VREF Unconnected, $T_A = 25^\circ C$, Unless Otherwise Specified (Continued)

PARAMETER	TEST CONDITION	MIN	TYP	MAX	UNITS
External Voltage Reference	VREF = 1.230V (Figure 27), RSET = 140 Ω	-	-	± 10	%
DAC to DAC Matching		-	-	5	%
VREF Output Voltage	Pin not connected, using internal reference	1.13	1.19	1.32	V
VREF Output Current		-50	-	50	μA
VREF Input Voltage	Pin connected to external reference.	1.11	1.23	1.36	V
VREF Input Current		-500	-	500	μA
AC PARAMETERS, ANALOG OUTPUTS					
Differential Gain Error	Using analog output filter shown in Figure 28A	-	0.8	-	%
Differential Phase Error		-	0.8	-	Degree
SNR (Weighted)		-	70	-	dB
Hue Accuracy		-	2	-	Degree
Color Saturation Accuracy		-	2	-	%
Luminance Nonlinearity		-	1	-	%
Residual Subcarrier		-	-60	-	dB
SCH Phase	SCH Phase Reset enabled	-	± 1.5	-	Degree
Analog Output Skew, T_{ASK}		-	-	3	ns
Analog Output Delay, T_{AD}		-	-	12	ns
DAC-DAC Crosstalk		-	-60	-	dB
Glitch Energy	Using analog output filter shown in Figure 28A. Includes clock and data feedthrough	-	35	-	pV-s
AC PARAMETERS, DIGITAL INPUTS AND OUTPUTS EXCEPT SCL AND SDA					
Setup Time, T_S	Note 6	8	-	-	ns
Hold Time, T_H		0	-	-	ns
CLK2 to Output Delay, T_D		3	-	15	ns
CLK2 Frequency		-	-	30.0	MHz
CLK2 High Time, CLK2 _H		13.6	-	20.3	ns
CLK2 Low Time, CLK2 _L		13.6	-	20.3	ns
RESET* Pulse Width Low, T_{RES}		4	-	-	CLK Cycles
AC PARAMETERS, SCL AND SDA (I²C INTERFACE)					
All AC parameters meet the fast-mode I ² C Bus Interface specification.					
POWER SUPPLY CHARACTERISTICS					
DAC PSRR at DC	Note 7	-	64	-	dB
Power Supply Range, V_{AA}		4.75	5.0	5.25	V
Normal Supply Current, I_{AA}		-	-	210	mA
Power-Down Supply Current, I_{AA}	Note 8	-	-	750	μA
Power Dissipation		-	950	1050	mW

NOTES:

5. Output level is dependent on the voltage on VREF, the value of RSET, and the load.
6. Test performed with $C_L = 40pF$, $I_O = \pm 2mA$, $V_{IH} = 3.0V$, $V_{IL} = 0.0V$. Input reference level is 2.0V for all inputs.
7. The supply voltage rejection is the relative variation of the full-scale output driving a 37.5 Ω load for a $\pm 5\%$ supply variation:
 $PSRR = 20 \times \log(\Delta V_{AA} / \Delta V_{OUT})$.
8. If using an external voltage reference, it is not powered down. The internal voltage reference is powered down.

Typical Performance Curves

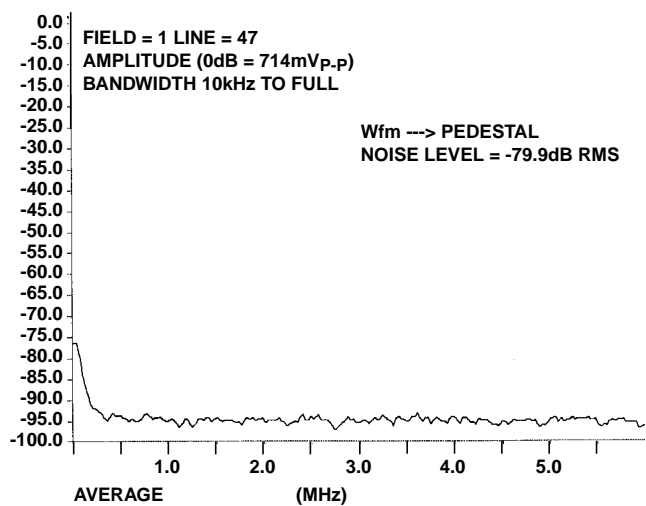

FIGURE 12. NOISE SPECTRUM (NTSC)

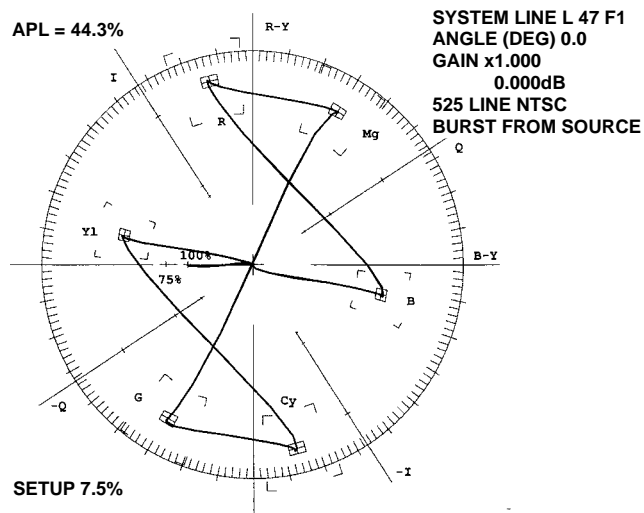

FIGURE 13. NTSC COLOR BAR VECTOR SCOPE PLOT

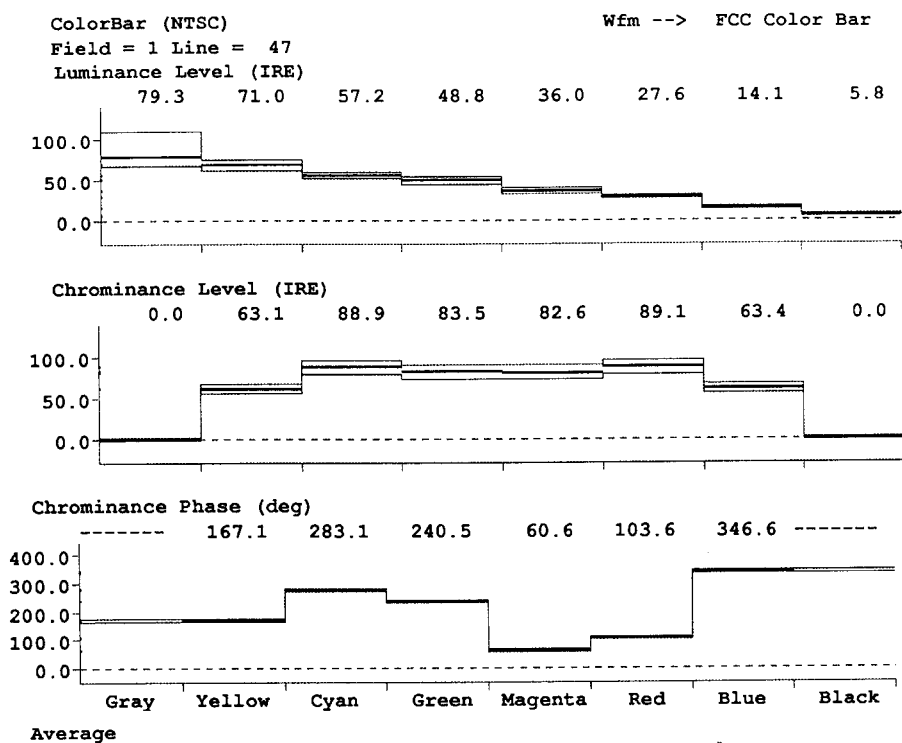

FIGURE 14. NTSC FCC COLOR BAR

Typical Performance Curves (Continued)

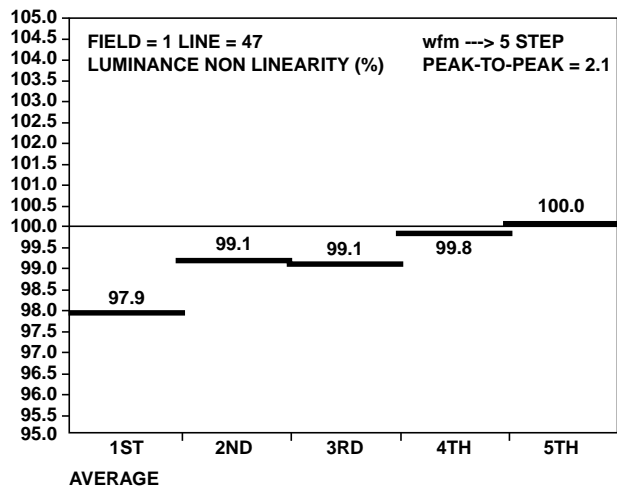

FIGURE 15. LUMINANCE NON LINEARITY (NTSC)

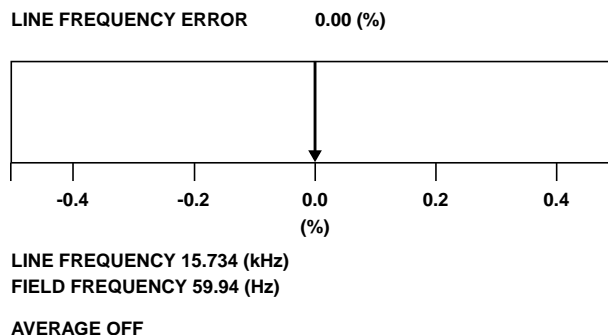

FIGURE 16. LINE FREQUENCY (NTSC)

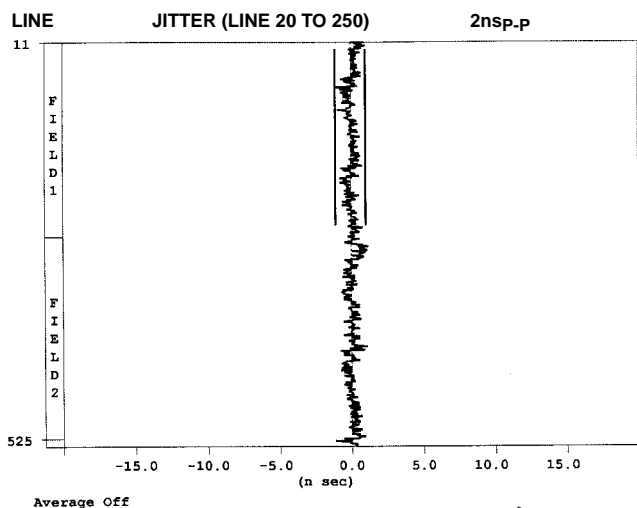

FIGURE 17. H SYNC JITTER IN A FRAME (NTSC)

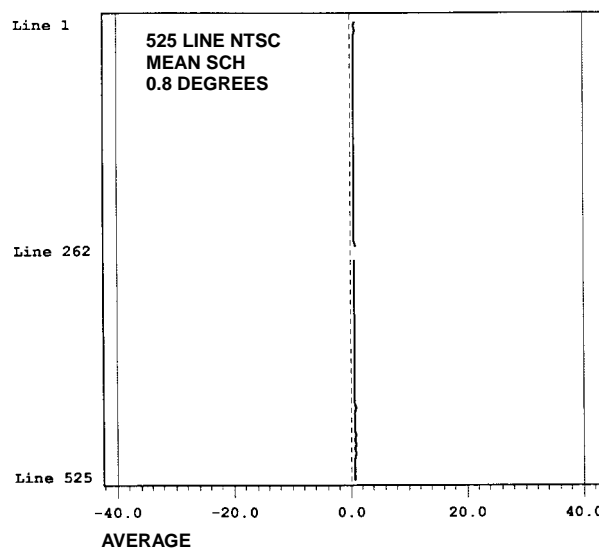

FIGURE 18. SCH PHASE MEASUREMENT

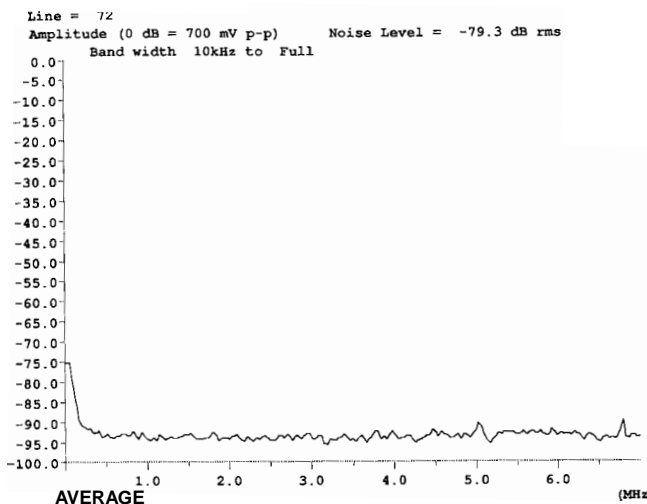

FIGURE 19. NOISE SPECTRUM (PAL)

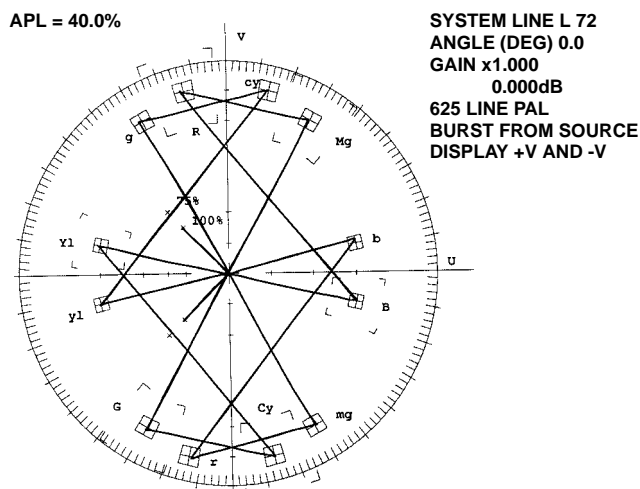

FIGURE 20. PAL COLOR BAR VECTOR SCAPE PLOT

Typical Performance Curves (Continued)

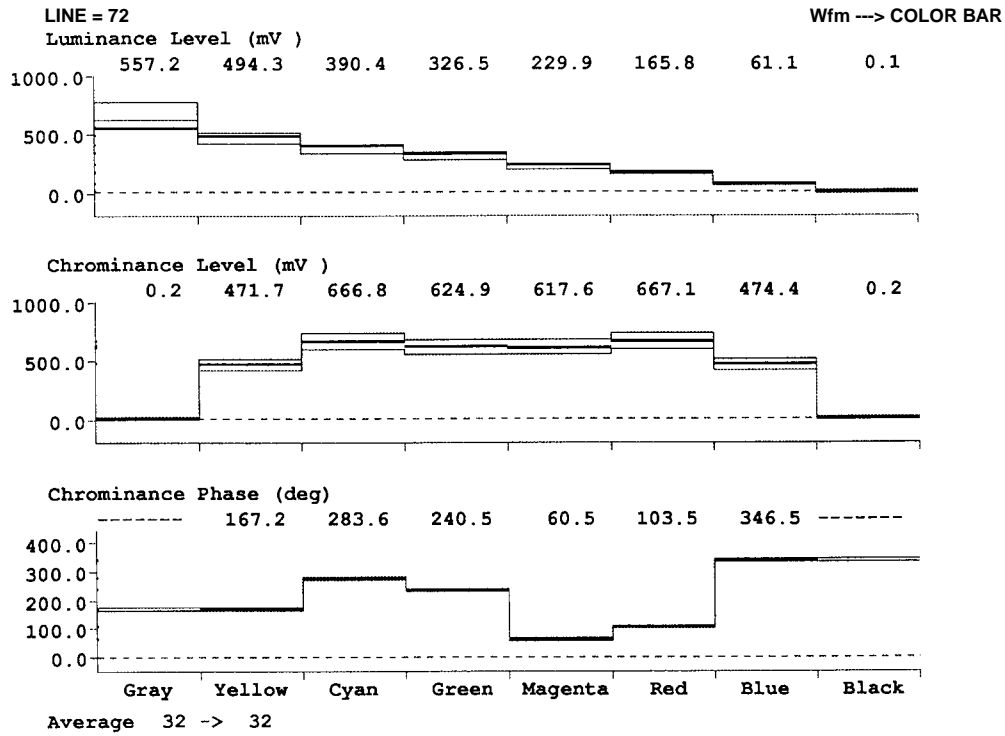

FIGURE 21. COLORBAR (PAL)

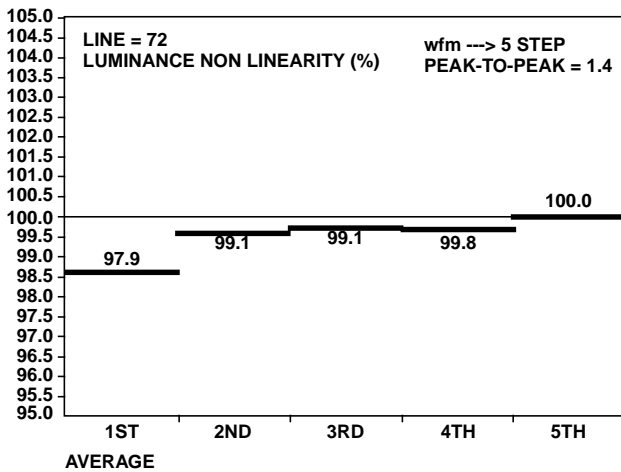

FIGURE 22. LUMINANCE NON LINEARITY (PAL)

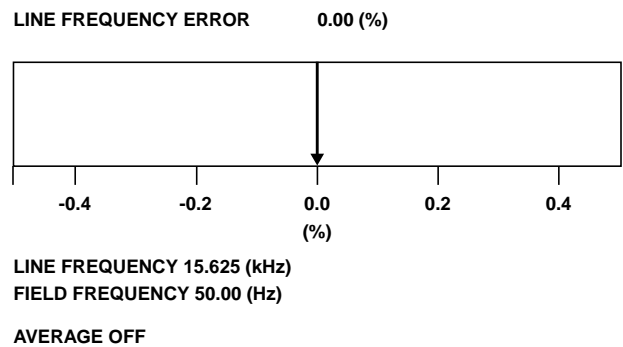

FIGURE 23. LINE FREQUENCY (PAL)

Typical Performance Curves (Continued)

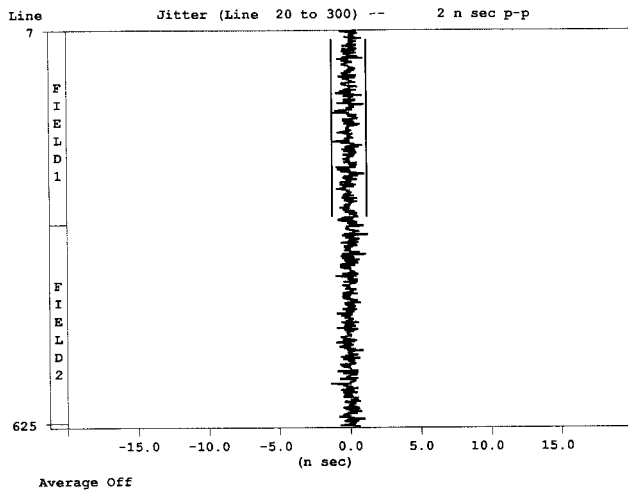

FIGURE 24. H SYNC JITTER IN A FRAME (PAL)

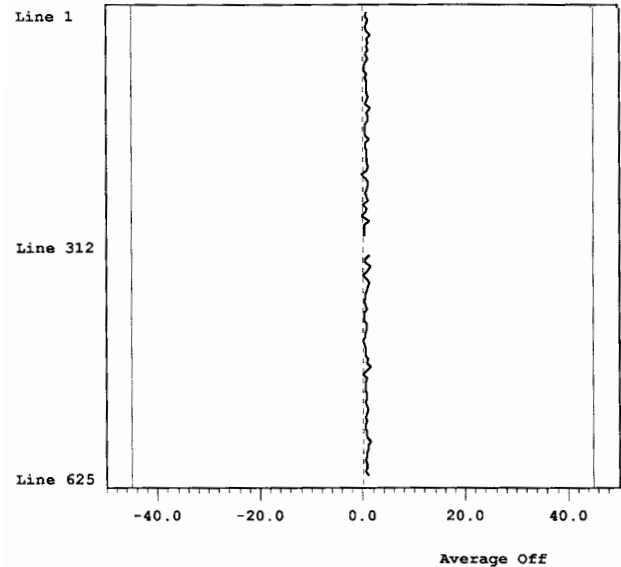

FIGURE 25. SCH PHASE MEASUREMENT

Application Information

PCB Considerations

A PCB board with a minimum of 4 layers is recommended, with layers 1 and 4 (top and bottom) for signals and internal layers 2 and 3 for power and ground. The PCB layout should implement the lowest possible noise on the power and ground planes by providing excellent decoupling. PCB trace lengths between groups of V_{AA} and GND pins should be as short as possible.

Component Placement

The optimum layout places the HMP8190/HMP8191 at the edge of the PCB and as close as possible to the video output connector. External components should be positioned as close as possible to the appropriate pin, ideally such that traces can be connected point to point. Chip capacitors are recommended where possible, with radial lead ceramic capacitors the second-best choice.

Traces containing digital signals should not be routed over, under, or adjacent to the analog output traces to minimize crosstalk. If this is not possible, coupling can be minimized by routing the digital signals at a 90 degree angle to the analog signals. The analog output traces should also not cross over or under the V_{CC} power plane to maximize high-frequency power supply rejection.

Power and Ground Planes

A common ground plane for all devices, including the HMP8190/HMP8191, is recommended. However, placing the encoder on an electrically connected GND peninsula reduces noise levels. All GND pins on the HMP8190/HMP8191 must be connected to the ground plane. Typical power and ground planes are shown in Figure 26.

The small connection between the ground areas should be made wide enough so that most of the encoders digital inputs can be routed over or under it. It is especially important that the CLK and CLK2 signals cross through the connection.

The HMP8190/HMP8191 should have its own power plane that is isolated from the common power plane of the board, with a gap between the two power planes of at least 1/8 inch. All V_{AA} pins of the HMP8190/HMP8191 must be connected to this isolated power plane.

The HMP8190/HMP8191 power plane should be connected to the board's normal V_{CC} power plane at a single point though a low-resistance ferrite bead, such as a Ferroxcube 5659065-3B, Fair-Rite 2743001111, or TDK BF45-4001. The ferrite bead provides resistance to switching currents, improving the performance of HMP8190/HMP8191. A single, large capacitor should also be used between the HMP8190/HMP8191 power plane and the ground plane to control low-frequency power supply ripple.

For proper operation, power supply decoupling is required. It should be done using a 0.1µF ceramic capacitor in parallel with a 0.01µF chip capacitor for each group of V_{AA} pins to ground. These capacitors should be located as close to the V_{AA} and GND pins as possible, using short, wide traces.

If a separate linear regulator is used to provide power to the HMP8190/HMP8191 power plane, the power-up sequence should be designed to ensure latching will not occur. A separate linear regulator is recommended if the power supply noise on the V_{AA} pins exceeds 200mV. About 10% of the noise (that is less than 1MHz) on the V_{AA} pins will couple onto the analog outputs.

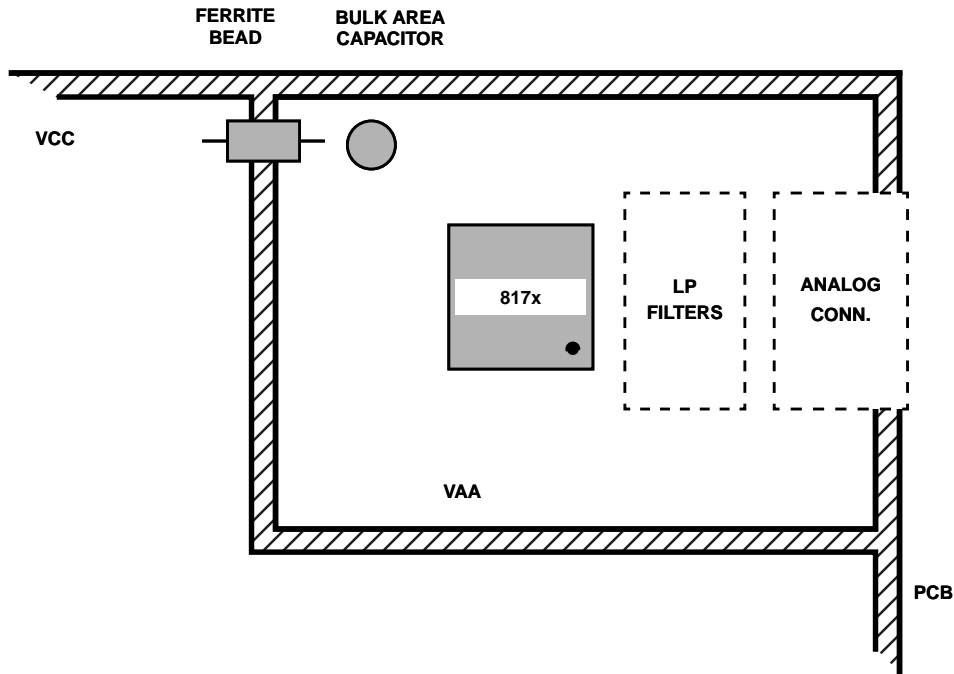

FIGURE 26A. V_{CC} AND V_{AA} PLANES

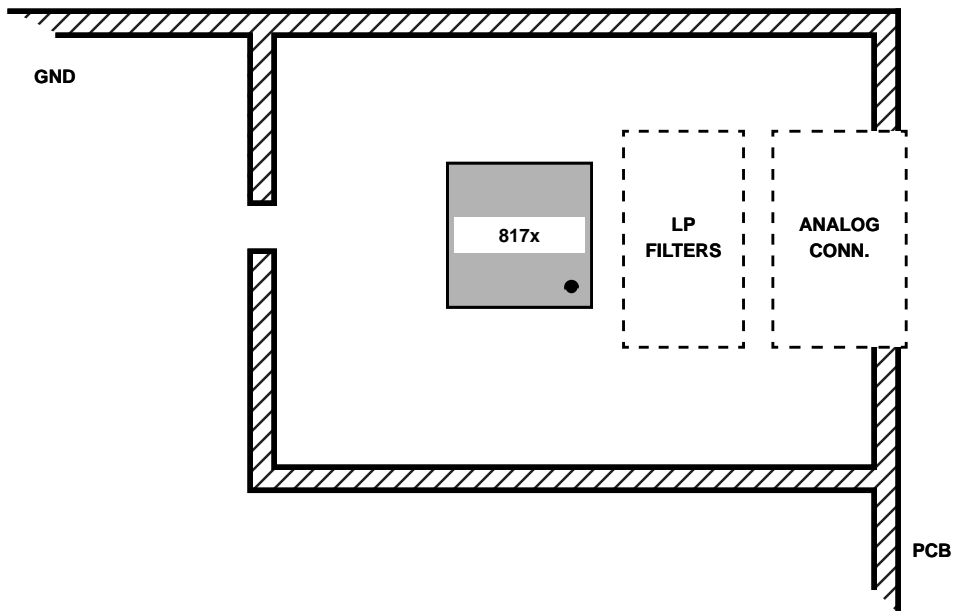

FIGURE 26B. COMMON GROUND PLANE

FIGURE 26. EXAMPLE POWER AND GROUND PLANES

External Reference Voltage

If an external reference voltage is used, its circuitry should receive power from the same plane as the HMP8190/HMP8191. The external VREF must also be stable and well decoupled from the power plane. An example VREF circuit using a band gap reference diode is shown in Figure 27.

Analog Output Filters

The various video standards specify the frequency response of the video signal. The HMP8190/HMP8191 uses 2X oversampling DACs to simplify the reconstruction filter required. Example post filters are shown in Figure 28. The analog output filters should be as close as possible to the HMP8190/HMP8191.

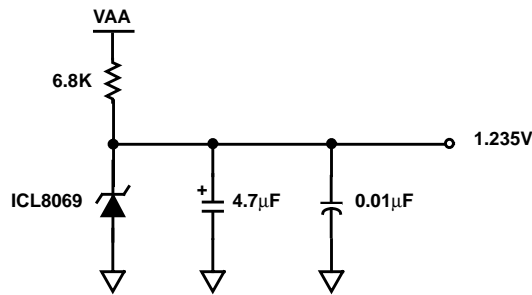

FIGURE 27. EXTERNAL REFERENCE VOLTAGE CIRCUIT

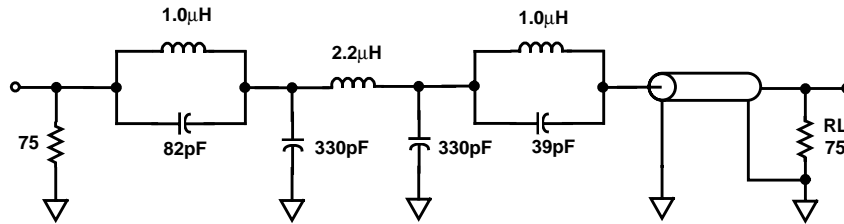

FIGURE 28A. HIGH QUALITY FILTER

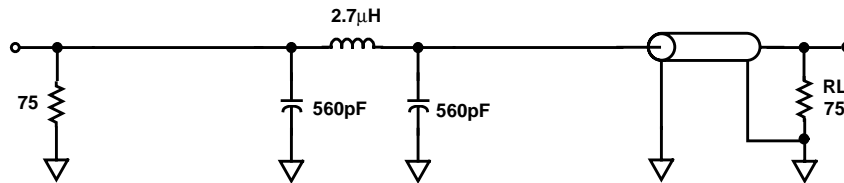

FIGURE 28B. LOW COST FILTER

FIGURE 28. EXAMPLE POST-FILTER CIRCUITS

Evaluation Kits

The HMP8190EVAL1 is a small (index card size) printed circuit board containing the encoder, voltage references and bypassing, analog output filters, and input/output connectors. The board allows the encoder's operation and performance to be observed and measured.

The HMP8190EVAL1 board has a 50 pin, two row receptacle which allows connection into an existing system. The connector provides access to all of the encoder's digital inputs and outputs.

The HMP8156EVAL2 is the Intersil designed mother board for the HMP8190EVAL1. The mother board is a standard size PC add in card with an ISA bus interface and application software. The HMP8156EVAL2 kit is a complete system which allows demonstrating all of both encoders' operating modes. It has analog video inputs for composite, S-video, and component RGB signals. The analog signals are converted/decoded to the digital domain and input to the encoder. The board also provides a 3 megabyte video RAM for image capture and display and a BT.656 connector and interface.

For simpler operation, the HMP8190EVAL1 may also be driven by external power supplies, a BT.656 signal generator, and a PC parallel port. The evaluation kit includes application software to program the part using its I²C bus connected to the printer port. The board includes the standard 25 pin BT.656 connector and interface.

Metric Plastic Quad Flatpack Packages (MQFP/PQFP)

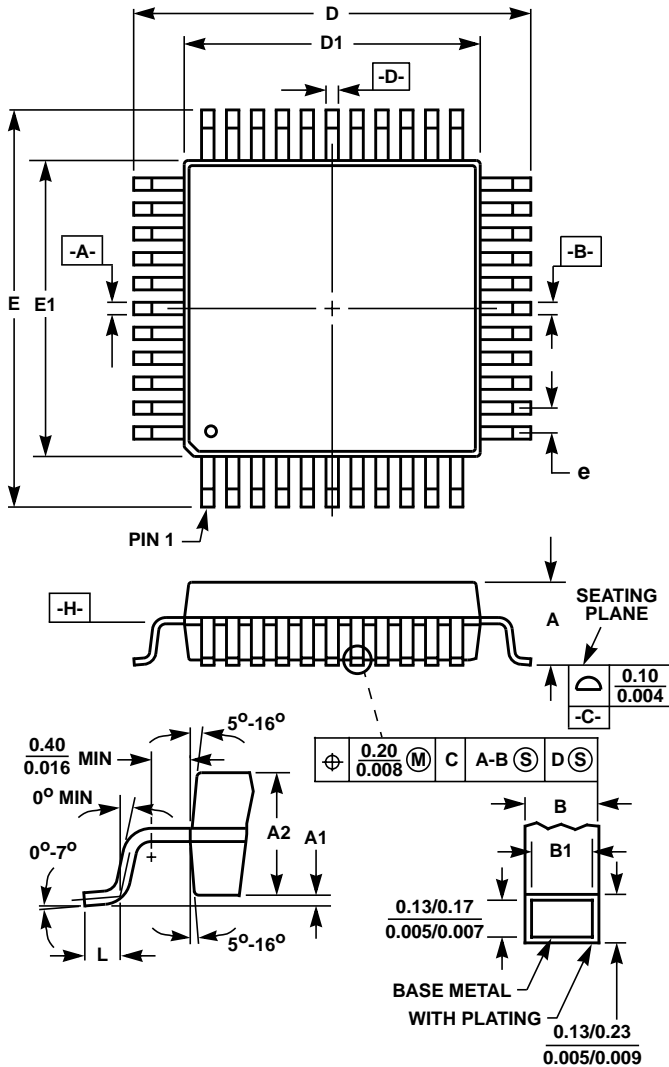

**Q64.14x14 (JEDEC MO-108BD-2 ISSUE A)
64 LEAD METRIC PLASTIC QUAD FLATPACK PACKAGE**

SYM-BOL	INCHES		MILLIMETERS		NOTES
	MIN	MAX	MIN	MAX	
A	-	0.130	-	3.30	-
A1	0.004	0.010	0.10	0.25	-
A2	0.100	0.120	2.55	3.05	-
B	0.012	0.018	0.30	0.45	6
B1	0.012	0.016	0.30	0.40	-
D	0.667	0.687	16.95	17.45	3
D1	0.547	0.555	13.90	14.10	4, 5
E	0.667	0.687	16.95	17.45	3
E1	0.547	0.555	13.90	14.10	4, 5
L	0.026	0.037	0.65	0.95	-
N	64		64		7
e	0.032 BSC		0.80 BSC		-

Rev. 0 1/94

NOTES:

- Controlling dimension: MILLIMETER. Converted inch dimensions are not necessarily exact.
- All dimensions and tolerances per ANSI Y14.5M-1982.
- Dimensions D and E to be determined at seating plane **-C-**.
- Dimensions D1 and E1 to be determined at datum plane **-H-**.
- Dimensions D1 and E1 do not include mold protrusion. Allowable protrusion is 0.25mm (0.010 inch) per side.
- Dimension B does not include dambar protrusion. Allowable dambar protrusion shall be 0.08mm (0.003 inch) total.
- "N" is the number of terminal positions.

All Intersil semiconductor products are manufactured, assembled and tested under **ISO9000** quality systems certification.

Intersil semiconductor products are sold by description only. Intersil Corporation reserves the right to make changes in circuit design and/or specifications at any time without notice. Accordingly, the reader is cautioned to verify that data sheets are current before placing orders. Information furnished by Intersil is believed to be accurate and reliable. However, no responsibility is assumed by Intersil or its subsidiaries for its use; nor for any infringements of patents or other rights of third parties which may result from its use. No license is granted by implication or otherwise under any patent or patent rights of Intersil or its subsidiaries.

For information regarding Intersil Corporation and its products, see web site <http://www.intersil.com>

Sales Office Headquarters

NORTH AMERICA

Intersil Corporation
P. O. Box 883, Mail Stop 53-204
Melbourne, FL 32902
TEL: (407) 724-7000
FAX: (407) 724-7240

EUROPE

Intersil SA
Mercure Center
100, Rue de la Fusee
1130 Brussels, Belgium
TEL: (32) 2.724.2111
FAX: (32) 2.724.22.05

ASIA

Intersil (Taiwan) Ltd.
7F-6, No. 101 Fu Hsing North Road
Taipei, Taiwan
Republic of China
TEL: (886) 2 2716 9310
FAX: (886) 2 2715 3029