

TOSHIBA

Fiber-Optic Devices TOSLINK™

PRODUCT GUIDE

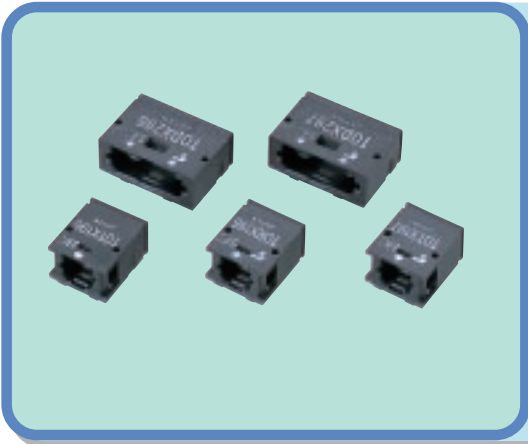



TOSLINK™ is a data transmission device which uses optical signals instead of electrical signals.

Its principal features are as follows:

- Electromagnetic noise has no effect on the transmission line.
- The transmission line does not radiate any electromagnetic noise.
- The device is as easy to handle as like a digital IC, and connector assembly is easy.

Comparison of TOSLINK and photocoupler

The function ability of TOSLINK is similar to that of a photocoupler. A photocoupler has light-emitting and light-receiving devices in one package. It is used to transmit electrical signals in a circuit, for a very short distance. TOSLINK can be imagined as follows: separate the emitting device from the receiving device in the center of a photocoupler, then re-connect the two devices using a long optical fiber cable. Because optical fiber is used as the transmission line, it is possible to transmit signals over long distances while isolating them using TOSLINK. As a result, TOSLINK is also sometimes referred to as a long-distance photocoupler.

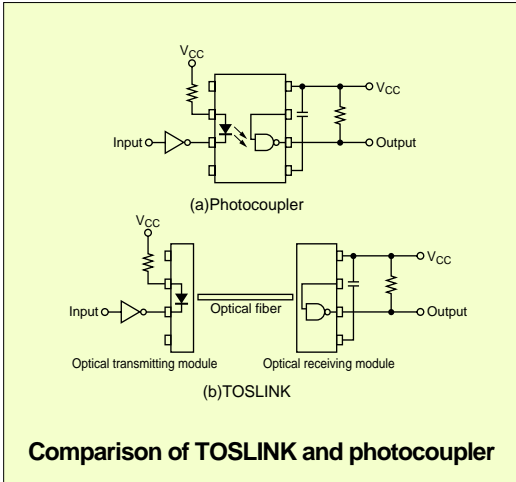

Electrical and optical transmission system

Electrical data transmission systems consist of the following devices: a line driver and line receiver to amplify electrical signals, a twisted-pair (or coaxial) cable as the transmission line and electrical connectors linking the line driver and line receiver to the electrical cable. By contrast, TOSLINK consist of the following devices: a transmitting module which converts electrical signals into optical ones, a receiving module which reconverts optical signals into electrical ones, optical fiber cable as the transmission line and optical connectors to link the transmitting and receiving modules to the optical fiber cable. In TOSLINK, a transmitting IC (LED driver) and LED are included in the transmitting module, and a receiving IC (waveform-reshaping circuit) and photodiode are included in the receiving module. The interface between transmitting and receiving ICs is at the transistor-transistor logic (TTL) or emitter coupled logic (ECL) levels. Because of this it is easy to make connections with the other circuits.

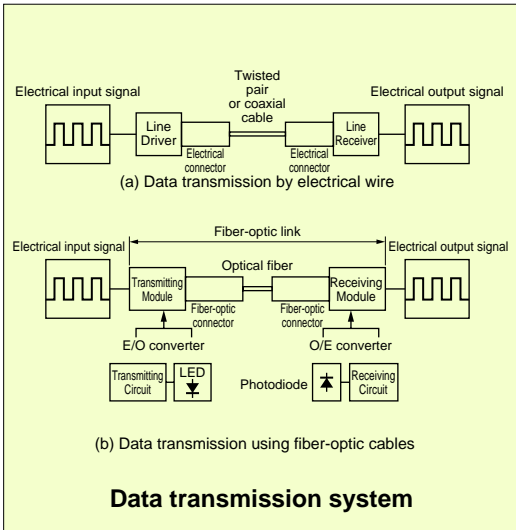

Note: TOSLINK is a trademark of Toshiba Corp.
 Raytela is a trademark of Toray Industries Inc.
 Eska Premier is a trademark of Mitsubishi Rayon Co. Ltd.
 Sumiguide is a trademark of Sumitomo Electronic Industries Ltd.

Optical fiber Cable

Optical fiber cable consists of two parts. The center is called the core, the outer layer is called the cladding. The refractive index of the core is higher than that of the cladding. The effect of this arrangement is that when an optical ray is propagated at an angle to the axis of the cable, it is reflected back at the boundary between the core and the cladding, and thereby transmitted longitudinally through the core.

There are three kinds of optical fiber:

- All-plastic fiber (APF)
- Plastic-cladding silica Fiber (PCF)
- Silica fiber

APF is used for short-distance data transmission. Both the core and the cladding are made of plastic. PCF, which is used for middle distance transmission, has silica core and plastic cladding. Silica fiber is used for long-distance transmission. Both the core and the cladding are made of silica.

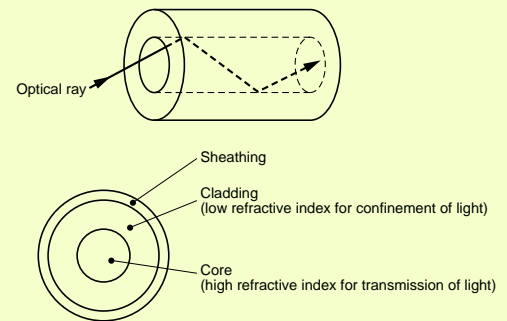

Structure of optical fiber cable

TOSLINK circuit configuration

Optical transmission module

The LED is driven by a differential circuit in the transmission module, making it possible to decrease current fluctuation when the LED is either on or off. For this reason, this module has no effect on other circuits around it.

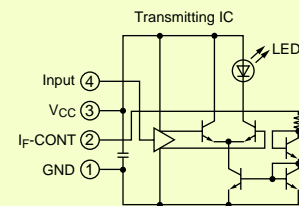

Block diagram of transmission module

Optical receiving module

An ATC (automatic threshold control) circuit is used to reshape the waveform in the receiving module. The ATC circuit controls the comparator reference voltage so that it is always automatically adjusted as the input optical power changes. For this reason there will be little pulse width distortion even when the length or degree of bending conditions of the optical fiber are changed.

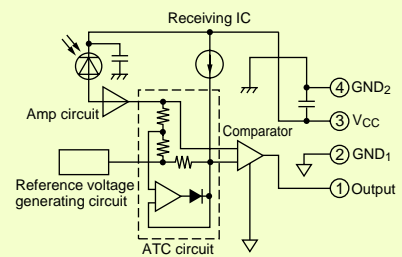

Block diagram of receiving module

Construction of TOSLINK

There are two package types available for TOSLINK's internal optical units. One is a molded resin package. It is used for ordinary applications. The other is ceramic, used for applications requiring exceptionally high reliability. The structure of the internal units of these two packages is shown in the figure on the right. In the case of the molded resin type, the devices are mounted on a lead frame and molded in with transparent resin.

In the ceramic package the devices are mounted on a ceramic substrate, and hermetically sealed by a metal shell.

The ceramic package features better resistance against humidity and temperature than the molded resin type.

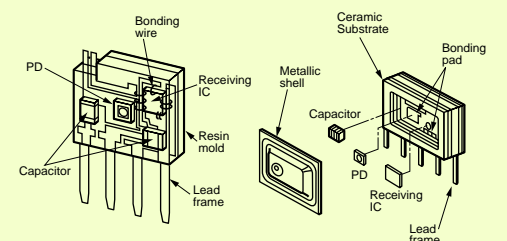

Molded resin package Ceramic package
Structure of internal units

TOSLINK devices can be classified as follows:

TOSLINK

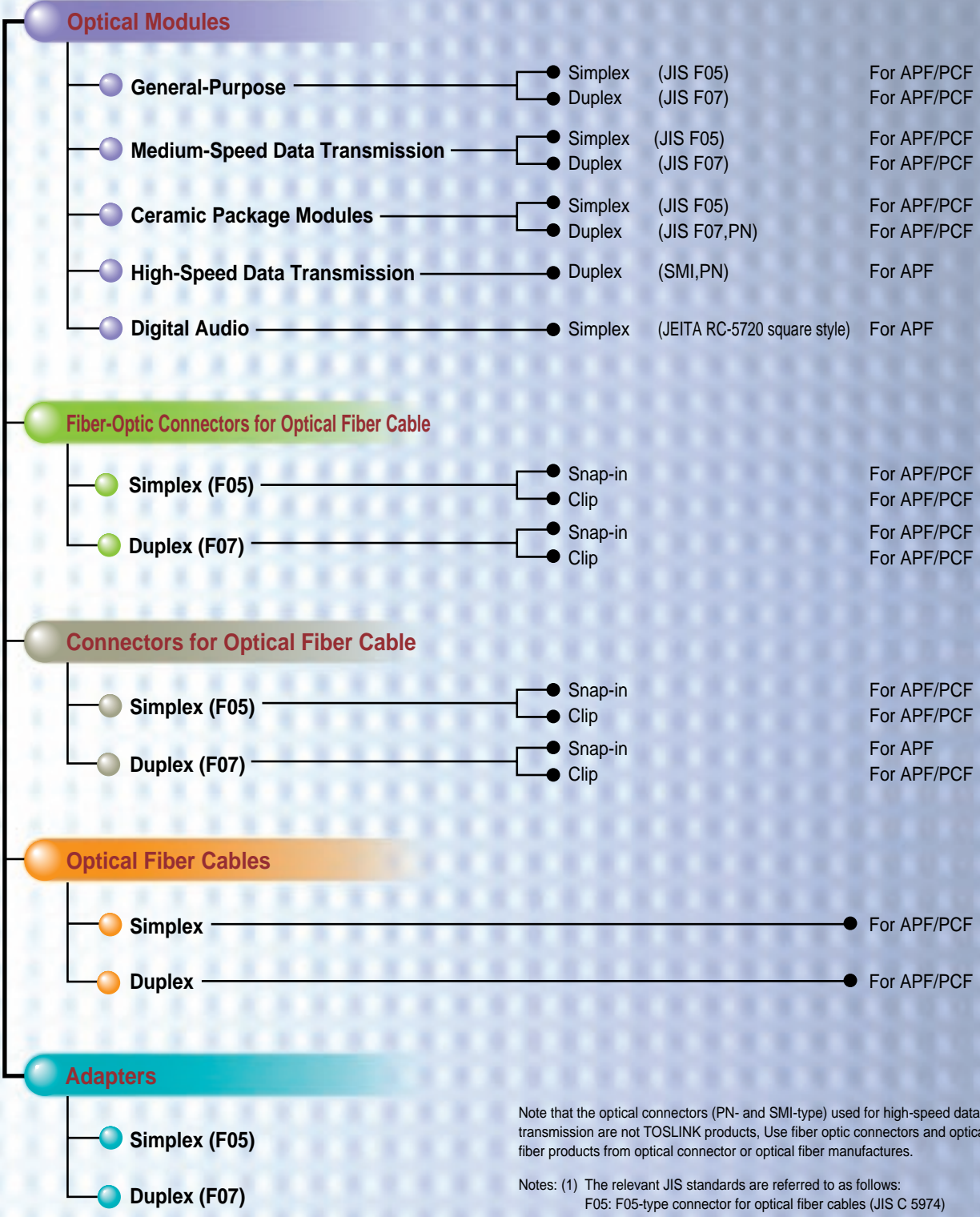

Note that the optical connectors (PN- and SMI-type) used for high-speed data transmission are not TOSLINK products. Use fiber optic connectors and optical fiber products from optical connector or optical fiber manufactures.

Notes: (1) The relevant JIS standards are referred to as follows:
 F05: F05-type connector for optical fiber cables (JIS C 5974)
 F07: F01-type connector for optical fiber cables (JIS C 5976)

Application examples of TOSLINK

TOSLINK is used in a wide variety of applications, such as digital audio and factory automation.

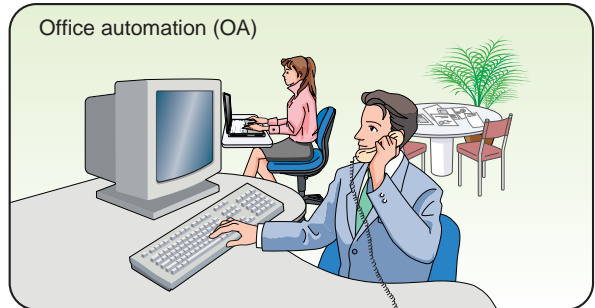
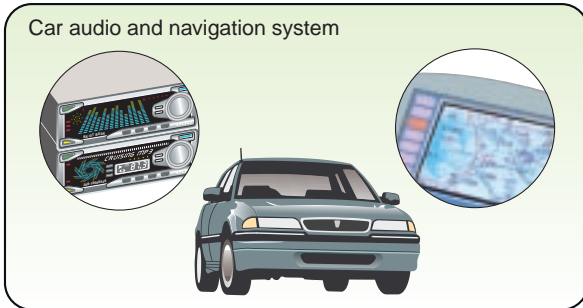
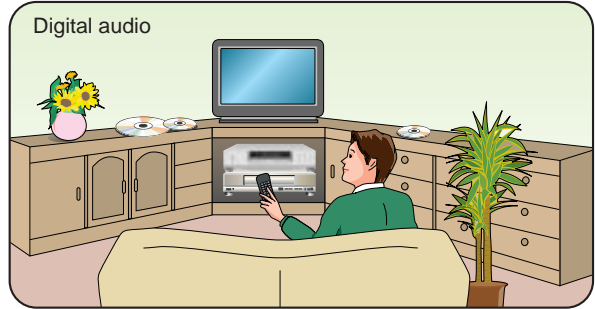
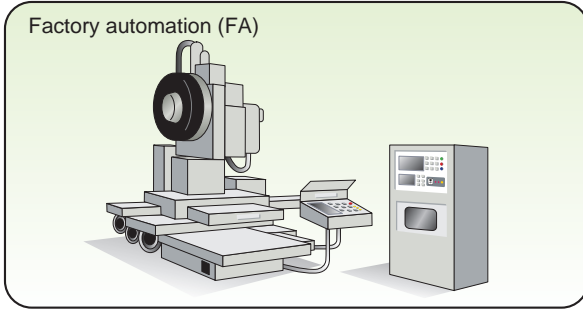

● Application examples of PC audio

● Application example of 1394 optical and OFL.

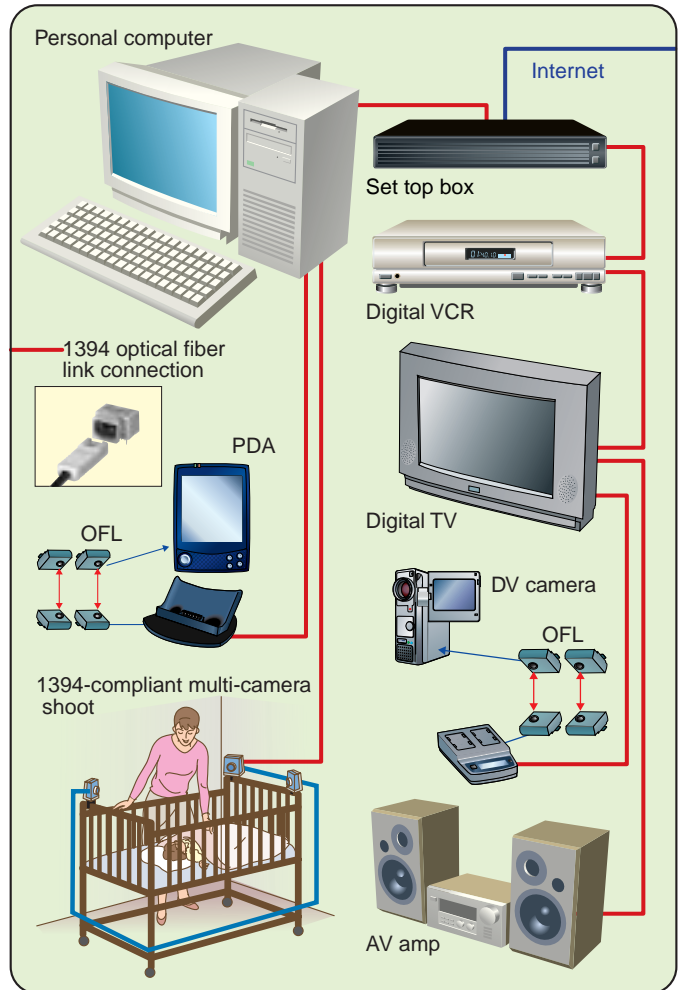
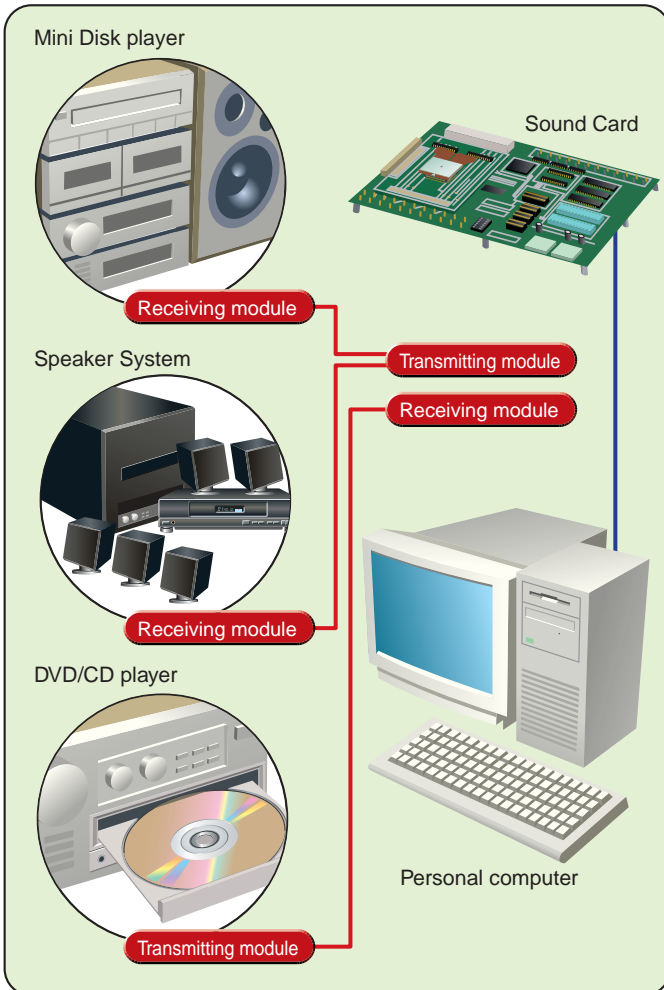

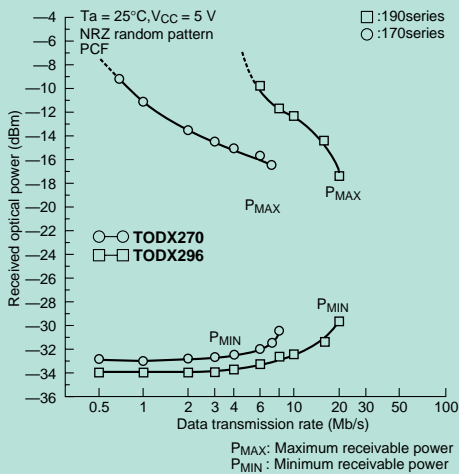

Dynamic range of devices for general-purpose use

There are two series in the TOSLINK family which are designed for general-purpose use. One is the TOSLINK 170 Series which was the first generation of TOSLINK. The other is the TOSLINK 190 Series, which is part of the new generation. The main technical features of modules for general-purpose use in the TOSLINK 190 Series are as follows:

- Data transmission rate: Up to 6 Mb/s or 8 Mb/s.
- Transmission distance: Up to 1000 m with PCF. Up to 40 m with APF.
- Wider dynamic range: 6 dB wider than the TOSLINK 170 Series.
- Constant external resistor value irrespective of transmission distance.

There are two connector types, the F05 (simplex) and F07 (duplex), which are available for both the TOSLINK 170 and 190 Series devices.

Application circuits

Application circuits for the TOTX197 and TORX196, a pair of transmitting and receiving modules for general-purpose use, are shown in the figure on the right. For the TOTX197 transmission module, an external resistor is required to supply current to the LED.

For the TORX196 receiving module, a noise filter must be placed on the power line. The module case is made of conductive resin in order to have a shielding effect against noise. All case pins must be securely grounded.

There are also duplex modules in the general-purpose TOSLINK series devices, but application circuits for these are generally the same as for simplex modules. Interfaces in these modules are all at the transistor-transistor logic (TTL) level; hence it is easy to connect them with other circuits.

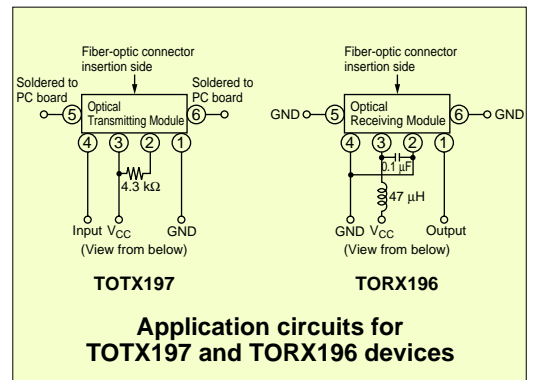

Application circuits for TOTX197 and TORX196 devices

Receiving module with analog output for an optical flux monitor (TORX198 and TODX298)

The general-purpose modules described above provide digital output. In addition there is also one receiving module (TORX198) with an analog output for amplifier.

The analog output voltage (output voltage of the amplifier in the receiving circuit) depends on the optical power input into the receiving module.

Hence, it is possible to measure optical flux without an optical power meter, by monitoring this analog output terminal.

When an optical flux-monitoring function is not required, this receiving module is used for digital data transmission, like the other TOSLINK receiving modules. In this case this analog output pin should be kept open.

There is also the optical module product having flux-monitoring functions such the duplex type TODX298 (for PCF cables).

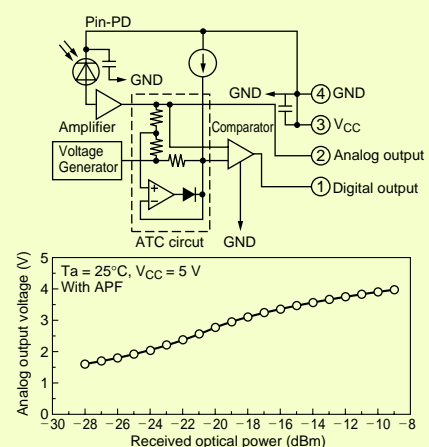

Receiving module with analog output for optical flux monitoring



The TOSLINK product line includes several ceramic-package modules, which have higher reliability levels than modules in molded-resin packages.

In these modules the LED, photodiode, transmission IC, receiving IC and chip capacitors are all mounted on a ceramic substrate and hermetically sealed in metal shells.

These ceramic-package modules are used in applications requiring high levels of reliability.

Structure of a ceramic-package module (transceiving unit)

The optical transceiving units used in optical modules have the following structure as shown in the figure on the right.

The LED, the transmitting IC which drives the LED and the chip capacitor are mounted on a ceramic substrate.

In this particular unit the photodiode, the receiving IC (which features a waveform-resaping function) and the chip capacitors are also mounted on the same ceramic substrate.

These devices are hermetically sealed in metal shells with glass windows.

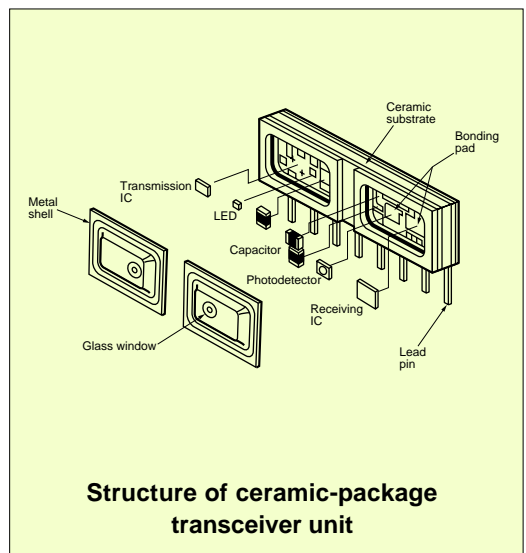

Ceramic-package transceiving module (TODX283)

TODX283 – high-speed optical module compatible with PN-type connectors
The TODX283 is a ceramic-package transceiving module which can be used with either an APF (all-plastic fiber) or a PCF (plastic-cladding silica-fiber) cable.

Just like a general-purpose optical module, this product incorporates a transmitting IC which drives an LED, and an on-chip receiving IC with a waveform-resaping function. It is easy to connect this module to peripheral circuits, since its input and output are both TTL-level.

This module is compatible with PN-type connectors and JIS F7-type fiber-optic connectors.

Main Specifications of the TODX283

- Data rate: DC to 50 Mb/s (NRZ code)
- Transmission distance: 10 m (max) (via APF cable)
100 m (max) (via PCF cable)
- Pulse width distortion: less than ± 7 ns
- Center wavelength: 650nm
- Operating temperature: -10°C to 70°C
- TTL interface



Optical modules for high-speed data transmission support two types of optical connectors, small multi-media interface (SMI) and premises network (PN).

The SMI optical connector is designed for use in digital home appliances and enables bi-directional (duplex) optical communication with its size as small as the simplex optical connector used for home digital audio equipment.

The PN optical connector is the modification of JIS F07 optical connector which has achieved success in industry application.

New Products

Optical Tranceiving Module with SMI Connector (TODX2402)

The TODX2402 optical tranceiving module is an optical transceiver used with the SMI connector which is designed for use in digital home appliances.

Since it can communicate at a data rate of 250 Mb/s, it is possible to transmit Fast Ethernet signals (125 Mb/s) as well as IEEE1394 S100 signals (125 Mb/s) and S200 signals (250 Mb/s).

Main specification of the TODX2402

- Data rate: 20 Mb/s to 250 Mb/s (NRZ code)
- Transmission distance: 20 m (max) (at 250 Mb/s)
50 m (max) (at 125 Mb/s)
- Center wavelength: 650 nm
- Operating temperature: 0°C to 60°C (at 250 Mb/s)
-10°C to 70°C (at 125 Mb/s)
- On-chip transmitting and receiving IC
- PECL interface
- Supply voltage: 3.3 V \pm 0.3 V
- Molded resin package



External appearance of optical tranceiving module TODX2402

Under development

Optical Tranceiving Module with PN Connector (TODX2801)

The TODX2801 optical tranceiving module is housed in a ceramic package which can be used with plastic optical fiber (APF) and plastic clad silica optical fiber (PCF).

It can be used to transmit Fast Ethernet signals (125 Mb/s) as well as IEEE1394 S100 signal (125 Mb/s) over longer distance with the PN optical connector or the JIS F07 optical connector.

Main specification of the TODX2801

- Data rate: 20 Mb/s to 125 Mb/s (NRZ code)
- Transmission distance: 20 m (max) (via APF cable)
100 m (max) (via GI-PCH cable)
- Center wavelength: 650 nm
- Operating temperature: -10°C to 70°C
- PECL interface
- Supply voltage: 3.3 V \pm 0.3 V
- Ceramic package



External appearance of optical tranceiving module TODX2801

Optical fiberless modules are used for high-speed data transmission and do not require optical fiber cables; hence, they are called optical fiberless (OFL) modules. Just like TOSLINK devices (which do require optical-fiber cables), these devices incorporate an on-chip transmission IC which drives an LED, and an on-chip receiving IC with a waveform-resaping function. As a result, it is easy to connect OFL modules to peripheral ICs.

New Products

Optical fiberless modules (TOTX1500 and TORX1500)

Main Specifications of the TOTX1500 and TORX1500

- Data rate: 20 to 125 Mb/s (NRZ code)
- Transmission distance: 3 cm (max)
- Center wavelength: 870 nm
- Operating temperature: 0°C to 60°C
- On-chip transmitting and receiving IC
- Supply voltage: 3.3 V ± 0.3 V
- PECL interface

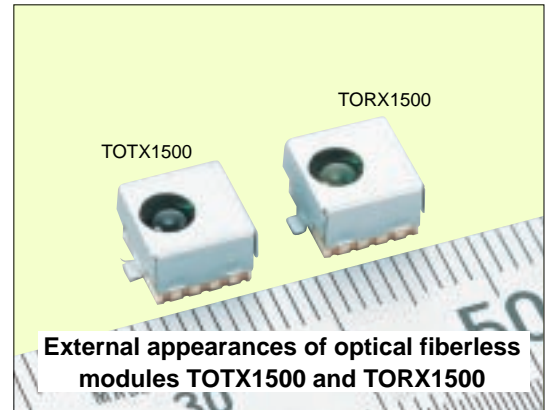

OFL application

The use of TOTX1500 and TORX1500 OFL modules in notebook PCs, DV cameras and high-performance PDAs enables high-speed data transmission between devices.

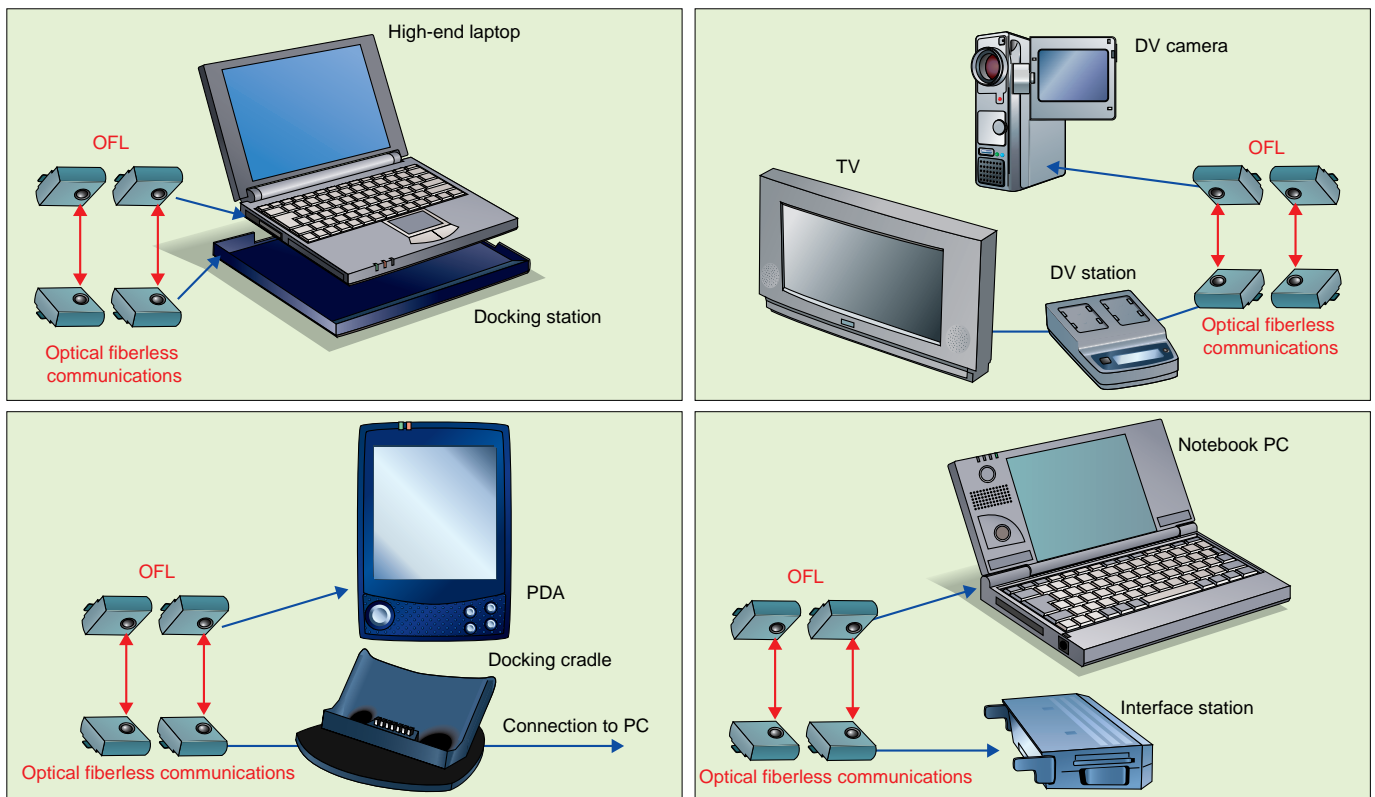



Standard package Medium-sized package Mini-package

Optical module packages for digital audio

The digital audio TOSLINK is an optical module capable of transferring digital audio interface signals.

The interface level and fiber-optic connector configuration conform to the JEITA standards CP-1201 and RC-5720 respectively. This module is therefore ideal for use in a wide variety of fields ranging from audio equipment such as CD, MD and DVD players to sound applications for personal computers and computer entertainment systems.

The digital audio TOSLINK comes in a standard package (panel mount type), a medium-sized package (for PC sound cards) and a mini-package (for portable devices). Choose the package which is most suitable for your application.

Connection method

The diagram shows the TOTX179 and TORX179 optical module connections for general audio applications.

Please connect a bypass capacitor to the optical transmitting module TOTX179 and a capacitor and inductor noise filter to the optical receiving module TORX179.

Since the optical transmitting module TORX179 incorporates a resistor for supplying current to the LED driver, no external resistors are required.

Products with different packages, such as the TOTX179S and the TORX179P, can also be connected and used in the same way.

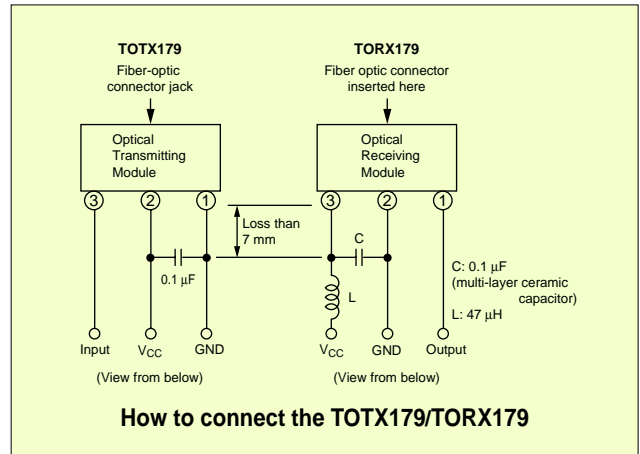

New Products

Optical Modules with Shutter TOTX141L, TOTX141PL, TORX141L, and TORX141PL

The TOTX141L is a panel mount optical transmission module with shutter, which can operate at a data rate of up to 15 Mb/s. Also, the TOTX141PL is an optical transmission module with shutter, which can operate at a data rate of up to 15 Mb/s. It is housed in a mini package. The TORX141L is a panel mount optical receiving module with shutter, is an optical receiving module with shutter, which can operate at a data rate of up to 15 Mb/s. It is housed in a mini package.

The TOTX141L, TOTX141PL, TORX141L and TORX141PL can operate at 3-V supply voltage.

Operating at a data rate of 15 Mb/s allows the modules to be used in digital audio equipment such as DVD players, which uses a sampling frequency of 96 kHz, as well as the conventional audio application, such as CD players and mini disc players.

Since these modules conform to the JEITA digital audio interface standard, they can be combined with existing digital audio TOSLINK products.

Toshiba also provides the optical transmission modules TOTX179L and TOTX179PL, and the optical receiving modules TORX179L and TORX179PL. These modules operate at 5-V supply voltage.



TOTX141L TORX141PL



TOTX141L TORX141PL

External appearances of TOTX141L/141PL and TORX141L/141PL

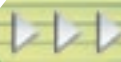

The TOSLINK product line includes are optical-fiber cables with fiber-optic connectors which conform to JIS F05 and JIS F07 standards.

The meaning of a product number is as follows:

TOCP □ □ □ □ - □ □ **B**

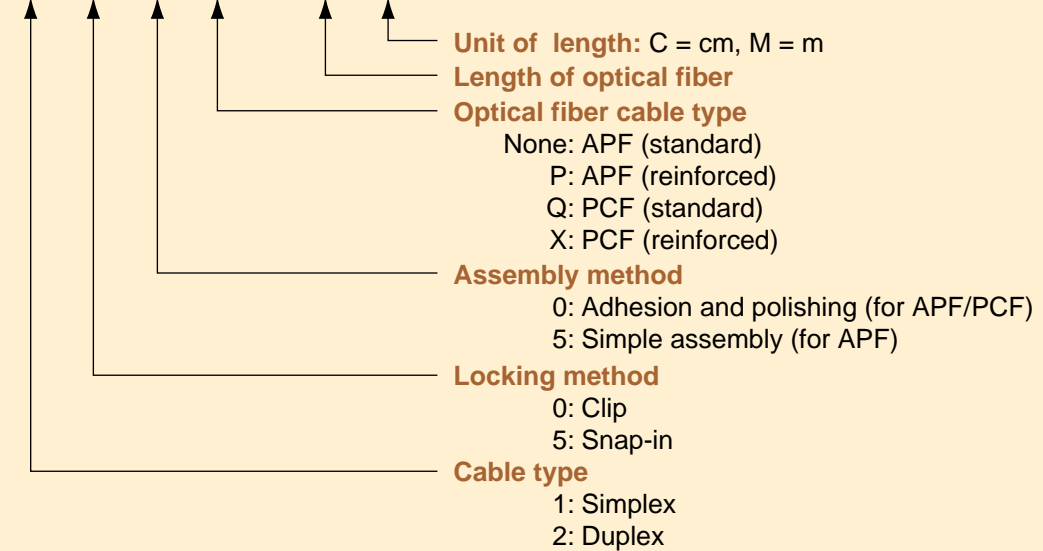

Sample product numbers

TOCP100X-100MB







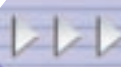





Cable type: Simplex
Locking method: Clip
Assembly method: Adhesion and polishing
Cable type: PCF (reinforced)
Length of cable: 100 m

TOCP255-50CB

Cable type: Duplex
Locking method: Snap-in
Assembly method: Simple assembly
Cable type: APF (standard)
Length of cable: 50 cm



1. Optical Modules for General-Purpose Use (simplex)

Transmitting Module	Receiving Module	Data Rate (Mb/s, NRZ)	Wavelength (nm)	Transmission Distance (m) ⁽¹⁾	Pulse Width Distortion (ns) ⁽¹⁾	Power Supply Voltage (V)	Operating Temperature (°C)	Appropriate Optical Fiber Cable (μm)	Appropriate Optical Fiber Cable with Fiber-Optic Connectors
TOTX196 	TORX196 	DC to 6	800	Up to 1000	± 55	5 ± 0.25	- 40 to 85	PCF (200/300)	TOCP100Q-□□B/TOCP100X-□□B
				Up to 800				H-PCF (200/230)	CF-1071 Series ⁽⁴⁾
TOTX196 	TORX198 ⁽²⁾ 	DC to 6	800	Up to 1000	± 55	5 ± 0.25	- 40 to 85	PCF (200/300)	TOCP100Q-□□B/TOCP100X-□□B
				Up to 800				H-PCF (200/230)	CF-1071 Series ⁽⁴⁾
TOTX170 ⁽³⁾ 	TORX170 	DC to 6	800	Up to 1000	± 55	5 ± 0.25	- 40 to 70	PCF (200/300)	TOCP100Q-□□B/TOCP100X-□□B
				Up to 800				H-PCF (200/230)	CF-1071 Series ⁽⁴⁾
TOTX197 	TORX196 	DC to 6	670	Up to 40	± 55	5 ± 0.25	- 40 to 85	APF (980/1000)	TOCP100-□□B/TOCP100P-□□B TOCP155-□□B/TOCP155P-□□B
TOTX197 	TORX198 ⁽²⁾ 	DC to 6	670	Up to 40	± 55	5 ± 0.25	- 40 to 85	APF (980/1000)	TOCP100-□□B/TOCP100P-□□B TOCP155-□□B/TOCP155P-□□B
TOTX170A ⁽³⁾ 	TORX170 	DC to 6	650	Up to 40	± 55	5 ± 0.25	- 40 to 70	APF (980/1000)	TOCP100-□□B/TOCP100P-□□B TOCP155-□□B/TOCP155P-□□B

Notes : (1) Value for operation at Ta = 25°C, Vcc = 5 V

(2) Optical receiving module with analog output pin used for optical flux monitoring

(3) It is necessary to change the external resistor value according to the transmission distance.

(4) CF-1071 Series is manufactured of Sumitomo Electronic Industries Ltd.

2. Optical Modules for General-Purpose Use (duplex)

Transceiving Module	Data Rate (Mb/s, NRZ)	Wavelength (nm)	Transmission Distance (m) ⁽¹⁾	Pulse Width Distortion (ns) ⁽¹⁾	Power Supply Voltage (V)	Operating Temperature (°C)	Appropriate Optical Fiber Cable (μm)	Appropriate Optical Fiber Cable with Fiber-Optic Connectors
TODX296 	DC to 6	800	Up to 1000	± 55	5 ± 0.25	- 40 to 85	PCF (200/300)	TOCP200Q-□□B/TOCP200X-□□B
			Up to 800				H-PCF (200/230)	CF-2071 Series ⁽⁵⁾
TODX298 ⁽²⁾ 	DC to 8	800	Up to 1000	± 42	5 ± 0.25	- 40 to 85	PCF (200/300)	TOCP200Q-□□B/TOCP200X-□□B
			Up to 700				H-PCF (200/230)	CF-2071 Series ⁽⁵⁾
TODX270 ⁽³⁾ 	DC to 6	800	Up to 1000	± 55	5 ± 0.25	- 40 to 70	PCF (200/300)	TOCP200Q-□□B/TOCP200X-□□B
			Up to 800				H-PCF (200/230)	CF-2071 Series ⁽⁵⁾
TODX297 	DC to 6	670	Up to 40	± 55	5 ± 0.25	- 40 to 85	APF (980/1000)	TOCP200-□□B/TOCP200P-□□B TOCP255-□□B/TOCP255P-□□B
TODX270A ⁽³⁾ 	DC to 6	650	Up to 40	± 55	5 ± 0.25	- 40 to 70	APF (980/1000)	TOCP200-□□B/TOCP200P-□□B TOCP255-□□B/TOCP255P-□□B





Notes : (1) Value for operation at Ta = 25°C, Vcc = 5 V

(2) Optical receiving module with analog output pin used for optical flux monitoring

(3) It is necessary to change the external resistor value according to the transmission distance.

(5) CF-2071 Series is manufactured of Sumitomo Electronic Industries Ltd.

3. Optical Modules for Medium-Speed Data Transmission (simplex)



Transmitting Module	Receiving Module	Data Rate (Mb/s, NRZ)	Wavelength (nm)	Transmission Distance (m) ⁽¹⁾	Pulse Width Distortion (ns) ⁽¹⁾	Power Supply Voltage (V)	Operating Temperature (°C)	Appropriate Optical Fiber Cable (μm)	Appropriate Optical Fiber Cable with Fiber-Optic Connectors
TOTX194 ⁽³⁾ 	TORX194 	DC to 10	800	Up to 1000	± 30	5 ± 0.25	- 40 to 85	PCF (200/300)	TOCP100Q-□□B/TOCP100X-□□B
				Up to 700				H-PCF (200/230)	CF-1071 Series ⁽⁴⁾
TOTX195 ⁽³⁾ 	TORX194 	DC to 10	670	Up to 50	± 30	5 ± 0.25	- 40 to 85	APF (980/1000)	TOCP100-□□B/TOCP100P-□□B TOCP155-□□B/TOCP155P-□□B

Notes : (1) Value for operation at Ta = 25°C, Vcc = 5 V

(3) It is necessary to change the external resistor value according to the transmission distance.

(4) CF-1071 Series is manufactured of Sumitomo Electronic Industries Ltd.

4. Optical Modules for Medium-Speed Data Transmission (duplex)



Transceiving Module	Data Rate (Mb/s, NRZ)	Wavelength (nm)	Transmission Distance (m) ⁽¹⁾	Pulse Width Distortion (ns) ⁽¹⁾	Power Supply Voltage (V)	Operating Temperature (°C)	Appropriate Optical Fiber Cable (μm)	Appropriate Optical Fiber Cable with Fiber-Optic Connectors
TODX294 ⁽³⁾ 	DC to 10	800	Up to 1000	± 30	5 ± 0.25	- 40 to 85	PCF (200/300)	TOCP200Q-□□B/TOCP200X-□□B
			Up to 700				H-PCF (200/230)	CF-2071 Series ⁽⁵⁾
TODX295 ⁽³⁾ 	DC to 10	670	Up to 50	± 30	5 ± 0.25	- 40 to 85	APF (980/1000)	TOCP200-□□B/TOCP200P-□□B TOCP255-□□B/TOCP255P-□□B

Notes : (1) Value for operation at Ta = 25°C, Vcc = 5 V

(3) It is necessary to change the external resistor value according to the transmission distance.

(5) CF-2071 Series is manufactured of Sumitomo Electronic Industries Ltd.

5. Ceramic Package Modules (simplex)

Transmitting Module	Receiving Module	Data Rate (Mb/s, NRZ)	Wavelength (nm)	Transmission Distance (m) ⁽¹⁾	Pulse Width Distortion (ns) ⁽¹⁾	Power Supply Voltage (V)	Operating Temperature (°C)	Appropriate Optical Fiber Cable (μm)	Appropriate Optical Fiber Cable with Fiber-Optic Connectors
TOTX180 	TORX186 	DC to 8	800	Up to 1000	± 42	5 ± 0.25	- 40 to 85	PCF (200/300)	TOCP100Q-□□B/TOCP100X-□□B
				Up to 800				H-PCF (200/230)	CF-1071 Series ⁽⁴⁾
TOTX180 ⁽³⁾ 	TORX180 ⁽³⁾ 	DC to 6	800	Up to 1000	± 55	5 ± 0.25	- 40 to 85	PCF (200/300)	TOCP100Q-□□B/TOCP100X-□□B
				Up to 800				H-PCF (200/230)	CF-1071 Series ⁽⁴⁾
TOTX180A ⁽³⁾ 	TORX180 ⁽³⁾ 	DC to 6	650	Up to 40	± 55	5 ± 0.25	- 40 to 85	APF (980/1000)	TOCP100-□□B/TOCP100P-□□B TOCP155-□□B/TOCP155P-□□B



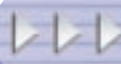

Notes : (1) Value for operation at Ta = 25°C, Vcc = 5 V

(3) It is necessary to change the external resistor value according to the transmission distance.

(4) CF-1071 Series is manufactured of Sumitomo Electronic Industries Ltd.

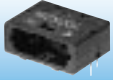

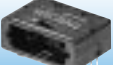
6. Ceramic Package Modules (duplex)



Transceiving Module	Data Rate (Mb/s, NRZ)	Wavelength (nm)	Transmission Distance (m) ⁽¹⁾	Pulse Width Distortion (ns) ⁽¹⁾	Power Supply Voltage (V)	Operating Temperature (°C)	Appropriate Optical Fiber Cable (μm)	Appropriate Optical Fiber Cable with Fiber-Optic Connectors
TODX286 	DC to 8	800	Up to 1000	± 42	5 ± 0.25	- 40 to 85	PCF (200/300)	TOCP200Q-□□B/TOCP200X-□□B
			Up to 800					H-PCF (200/230)
TODX280⁽³⁾ 	DC to 6	800	Up to 1000	± 55	5 ± 0.25	- 40 to 85	PCF (200/300)	TOCP200Q-□□B/TOCP200X-□□B
			Up to 800					H-PCF (200/230)
TODX280A⁽³⁾ 	DC to 6	650	Up to 40	± 55	5 ± 0.25	- 40 to 85	APF (980/1000)	TOCP200-□□B/TOCP200P-□□B TOCP255-□□B/TOCP255P-□□B
TODX283 	DC to 50	650	Up to 10 (APF)	± 7	5 ± 0.25	- 10 to 70	APF (980/1000)	PN fiber-optic cable connectors TOCP200-□□MB/TOCP200P-□□MB
			Up to 100 (PCF)					PCF (200/300)

Notes : (1) Value for operation at Ta = 25°C, Vcc = 5 V

(3) It is necessary to change the external resistor value according to the transmission distance.

(5) CF-2071 Series is manufactured of Sumitomo Electronic Industries Ltd.

7. Optical-Fiber Modules for High-Speed Data Transmission (duplex)

Transceiving Module	Data Rate (Mb/s, NRZ)	Wavelength (nm) ⁽⁶⁾	Transmission Distance (m) ⁽⁶⁾	Power Supply Voltage (V)	Operating Temperature (°C)	Appropriate Optical Fiber Cable (μm)	Appropriate Optical Fiber Cable with Fiber-Optic Connectors
TODX2402  New product	20 to 250M	650	Up to 20(250M)	3.3 ± 0.3	0 to 60	APF (980/1000)	SMI fiber-optic cable connectors
			Up to 50(125M)		-10 to 70		
TODX2801^{(7) (8)}  Under development	20 to 125M	650	Up to 20(APF)	3.3 ± 0.3	-10 to 70	APF (980/1000)	PN fiber-optic cable connectors TOCP200-□□B, TOCP200P-□□B
			Up to 100(GI-PCF)				



Notes : (6) Value for operation at Ta = 25°C, Vcc = 3.3 V.

(7) Technical specifications given in this table may differ from those on the product data sheet.

(8) Ceramic Package Product.



























(9) GI-PCF is manufactured of Sumitomo Electronic Industries Ltd.

8. Optical Fiber-Less Modules

Transmitting Module	Receiving Module	Data Rate (Mb/s, NRZ)	Wavelength (nm) ⁽⁶⁾	Transmission Distance (cm) ⁽⁶⁾	Power Supply Voltage (V)	Operating Temperature (°C)
TOTX1500 	TORX1500 	20 to 125M	870	Up to 3	3.3 ± 0.3	0 to 60

Note : (6) Value for operation at Ta = 25°C, Vcc = 3.3 V.

9. Optical Modules for Digital Audio (simplex)

Transmitting Module	Receiving Module	Data Rate (Mb/s, NRZ)	Wavelength (nm)	Transmission Distance (m) ⁽¹⁰⁾	Pulse Width Distortion (ns) ⁽¹⁰⁾	Power Supply Voltage (V)	Operating Temperature (°C)	Appropriate Optical Fiber Cable (μm)	Appropriate Optical Fiber Cable with Fiber-Optic Connectors
 TOTX178A	 TORX178B	0.1 to 6M	660	Up to 5	± 30	5 ± 0.25	-20 to 70	APF(970/1000) APF(980/1000)	TOCP172-□□B
 TOTX178S	 TORX178S	0.1 to 6M	660	Up to 5	± 30	5 ± 0.25	-20 to 70		
 TOTX179	 TORX179	0.1 to 12.8M	650	Up to 5	± 25	5 ± 0.25	-20 to 70		
 TOTX179L <small>New product</small>	 TORX179L <small>New product</small>	0.1 to 12.8M	650	Up to 5	± 25	5 ± 0.25	-20 to 70		
 TOTX179P	 TORX179P	0.1 to 12.8M	650	Up to 5	± 25	5 ± 0.25	-20 to 70		
 TOTX179PL <small>New product</small>	 TORX179PL <small>New product</small>	0.1 to 12.8M	650	Up to 5	± 25	5 ± 0.25	-20 to 70		
 TOTX179S	 TORX179S	0.1 to 12.8M	650	Up to 10	± 25	5 ± 0.25	-20 to 70		
 TOTX141	 TORX141	0.1 to 15M	650	Up to 10	± 20	2.7 to 3.6	-20 to 70		
 TOTX141L <small>New product</small>	 TORX141L <small>New product</small>	0.1 to 15M	650	Up to 10	± 20	2.7 to 3.6	-20 to 70		
 TOTX141P	 TORX141P	0.1 to 15M	650	Up to 10	± 20	2.7 to 3.6	-20 to 70		
 TOTX141PL <small>New product</small>	 TORX141PL <small>New product</small>	0.1 to 15M	650	Up to 10	± 20	2.7 to 3.6	-20 to 70		
 TOTX193	 TORX193	DC to 6M	660	Up to 10	± 25	5 ± 0.25	-40 to 85	APF(980/1000)	Audio DNP Connector ⁽¹¹⁾
 TOTX193K	 TORX193K	DC to 6M	660	Up to 10	± 25	5 ± 0.25	-40 to 85		

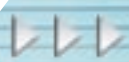

Notes : (10) Value for operation at Ta = 25°C, Vcc = 5.0V or Vcc = 3.0V

(11) Audio DNP Connector is manufactured of Tyco Electronics AMP K. K.



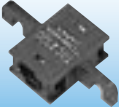

Adapter Product List





1. Simplex

Product Number	Max Transmission Loss (dB) ⁽¹⁾	Operating Temperature (°C)	Appropriate Fiber-Optic Connector
 TOCA100	2.0	-20 to 70	TOCP100•100P TOCP100Q•100Q TOCP150Q•150X
 TOCA150	3.5	-20 to 70	TOCP100•100P TOCP155•155P

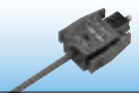

2. Duplex

Product Number	Max Transmission Loss (dB) ⁽¹⁾	Operating Temperature (°C)	Appropriate Fiber-Optic Connector
 TOCA200	2.0	-20 to 70	TOCP200•200P TOCP200Q•200X
 TOCA250	3.5	-20 to 70	TOCP200•200P TOCP255•255P

1. F05-Type (simplex)

Appearance	Product Number	Lock Type	Connector Product Number	Appropriate Optical Fiber Cable (diameter of core & cladding, μm)	Optical Fiber Cable Product Number	
	TOCP100-□□B	Clip	TOCP100K	APF (980/1000)	TOFC100-□□	
	TOCP100P-□□B		TOCP100PK		TOFC100P-□□	
	TOCP155-□□B	Snap-in	TOCP155K		PCF (200/300)	TOFC100-□□
	TOCP155P-□□B		TOCP155PK			TOFC100P-□□
	TOCP100Q-□□B	Clip	TOCP100QK		APF (980/1000)	TOFC100Q-□□
	TOCP100X-□□B		TOCP100XK			TOFC100X-□□
	TOCP150Q-□□B	Snap-in	TOCP150QK	PCF (200/300)		TOFC100Q-□□
	TOCP150X-□□B		TOCP150XK			TOFC100X-□□

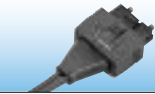
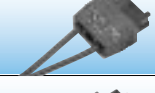
2. F07-Type (duplex)

Appearance	Product Number	Lock Type	Connector Product Number	Appropriate Optical Fiber Cable (diameter of core & cladding, μm)	Optical Fiber Cable Product Number	
	TOCP200-□□B	Clip	TOCP200K	APF (980/1000)	TOFC200-□□	
	TOCP200P-□□B		TOCP200PK		TOFC200P-□□	
	TOCP255-□□B	Snap-in	TOCP255K		PCF (200/300)	TOFC200-□□
	TOCP255P-□□B		TOCP255PK			TOFC200P-□□
	TOCP200Q-□□B	Clip	TOCP200QK		APF (980/1000)	TOFC200Q-□□
	TOCP200X-□□B		TOCP200XK			TOFC200X-□□

Note: P-type and X-type are reinforced cable.

3. For Digital Audio Use (simplex)

Appearance	Product Number	Lock Type	Connector Product Number	Appropriate Optical Fiber Cable (diameter of core & cladding, μm)	Optical Fiber Cable Product Number
	TOCP172-□□B	Snap-in	—	APF (970/1000)	—

Note: Available in assembled form only. Not available as connector parts for digital audio use.

1. F05 (simplex)

Product Number	Plug Case	Ferrule	Collar	Spring	Plug Cap	Cable Bushing	Protective Cap	Protective Sleeve
TOCP100K	VJA7076	VJM7066	—	VJM7069	VJA7083	—	VJA7115	—
TOCP100PK	VJA7076	VJM7066	—	VJM7069	VJA7083	—	VJA7115	VJA7133
TOCP155K	VJA7091	—	—	—	—	—	VJA7115	—
TOCP155PK	VJA7091	—	—	—	—	—	VJA7115	VJA7133
TOCP100QK	VJA7076	VJM7063	—	VJM7069	VJA7082	VJA7084	VJA7115	—
TOCP100XK	VJA7076	VJM7063	—	VJM7069	VJA7082	VJA7084	VJA7115	VJA7131
TOCP150QK	VJA7079	VJM7063	—	VJM7069	VJA7082	VJA7084	VJA7115	—
TOCP150XK	VJA7079	VJM7063	—	VJM7069	VJA7082	VJA7084	VJA7115	VJA7131

2. F07 (duplex)

Product Number	Plug Case	Ferrule	Collar	Spring	Plug Cap	Cable Bushing	Protective Cap	Protective Sleeve
TOCP200K	VJA7085	VJM7066	—	VJM7069	VJA7088	VJA7090	VJA7115	—
TOCP200PK	VJA7085	VJM7066	—	VJM7069	VJA7088	VJA7090	VJA7115	VJA7134
TOCP255K	VJA7092	—	—	—	—	—	VJA7115	—
TOCP255PK	VJA7092	—	—	—	—	—	VJA7115	VJA7134
TOCP200QK	VJA7085	VJM7063	—	VJM7069	VJA7088	VJA7090	VJA7115	—
TOCP200XK	VJA7085	VJM7063	—	VJM7069	VJA7088	VJA7090	VJA7115	VJA7132

Note: F07 connectors (duplex) require two ferrules, two springs and two protective caps.

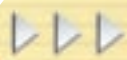

(1) Reliability

In an optical module that has been in use for some time, nearly all of the deterioration in characteristics is due to a reduction in the fiber-output power (Pf). This is due to deterioration over time in the level of optical output of the LED used as the light source. The drop in the LED's optical output is thought to be caused by crystal flaws in the wafer or stress in the mold resin, although the detailed causes are not clear.

Although LEDs used for optical communications are generally considered to have an almost infinite lifetime, their optical output does fall over time.

The life of light-emitting devices is greatly affected by the operating conditions and operating environment as well as by the lifespan characteristics of the particular device. Toshiba recommends that the user first check a device's lifetime characteristics before selecting it and setting its operating conditions.

For information on reliability, contact a Toshiba sales office. Regular maintenance, such as a check on the amount of light emitted is recommended.

In the case of the red LEDs used in the TOTX195 and TODX297, for example, a light-absorbing layer may form on the surface of the LED as the aluminum in the liquid crystal oxidizes, causing the optical output to fall. Since this tendency is pronounced in high-humidity environments, it is recommended that products containing red LEDs not be used in such environments. For high-humidity environments or applications requiring a long lifespan, Toshiba recommends a TOSLINK ceramic-package optical module.

(2) Soldering

Optical modules use semiconductor devices but are essentially optical components. When soldering, ensure that flux does not adhere to the light-emitting or light-receiving surfaces.

Take the same care when cleaning off flux after soldering.

Some optical modules include a protective cap. This cap is intended to prevent accidental operation when the module is not in use. It is not dust- or waterproof. Because the optical module is an optical component, Toshiba does not recommend soldering methods or post-solder flux cleaning methods in case where flux could affect the module. Toshiba recommends first soldering without mounting the module, then cleaning the PCB. The module should then be hand-soldered and no subsequent cleaning should be performed.

If it is not possible to hand-solder the module, one way of avoiding the effect of flux is to use non-halogen (chlorine-free) flux, taking care not to leave chlorine or other residue, and omitting the post-solder cleaning. In such cases too, the reliability of the device must be checked. Be sure to check the reliability of the device.

(3) Noise Resistance

The case for the TOSLINK (simplex) optical receiving module and (duplex) optical transceiver module is made of conductive plastic.

The case is designed to provide shielding when the reinforced pin at the front of the module is grounded. When the module is used, this pin should be connected SIGNAL-GND.

Since the case for the optical receiving module and optical transceiver module has a resistance of several tens of ohms, ensure that the case does not touch the power line or any other circuits.

Generally, the use of optical transmission devices is considered to improve noise resistance.

While optical fibers are certainly not affected by noise, optical modules, particularly receiver modules, are comparatively easily affected by noise because they handle such minute current signals.

To improve noise resistance, the TOSLINK case is treated to make it conductive. However, since the signal output from the optical receiving module photodiode is a minute current signal, in some environments simply shielding the case will not protect against noise. When using a TOSLINK device, conduct live tests to check noise resistance.

A simple noise filter is mandatory for the power lines for the TOSLINK optical receiving module and optical transceiver module.

However, in the case of significant power supply ripples, further filter reinforcement is also necessary. In addition, when the optical module is placed in a location susceptible to emission noise, Toshiba recommends covering the optical module and power supply filter with a metal cover to enhance the shielding.

(4) Protective Cap

When the optical module is not in use, cover it with the protective cap.

Take particular care with the optical receiving module since, depending on the circuit used, extraneous light may be input to the module when the TOSLINK device is not in use and may adversely affect other circuits.

(5) Vibration, Shock and Stress

Plastic-molded optical modules are plastic-sealed devices whose wires are fixed with resin. While this structure makes them comparatively resistant to vibration and shock, wire breakage has been observed in equipment in which the module is used when the soldering and connections are exposed to vibration, shock or stress. Therefore, when using a plastic-molded optical module in equipment with high vibration levels, ensure that the structure is designed to withstand vibration, shock and stress.

Ceramic-package optical modules are ceramic-sealed, with a hollow interior. Since the wires in the module are not fixed, the module is susceptible to vibration and shock.

Therefore, when using a ceramic-package optical module in equipment which is subject to high levels of vibration and shock, ensure that the structure of the equipment is designed to withstand vibration, shock and stress.

(6) Supply Voltage

Modules should be used with a supply voltage within the standard operating conditions. Ensure that the supply voltage does not exceed the absolute maximum rating even momentarily.

(7) Input Voltage

If a voltage exceeding the absolute maximum rating is applied to the transmitter input, the internal IC may be adversely affected or destroyed. If there is a possibility of excessive input voltage due to a surge, for example, add a protector circuit to the input.

(8) Output

Note that internal ICs can be damaged when the receiver output is low and the output is shorted to the power supply, or when output is high and is shorted to GND.

(9) Handling Optical Fiber Cables

Do not drop heavy or sharp metal objects onto the optical fiber cable. If the fiber cable breaks, data cannot be transmitted. Also, transmission loss increases with sharp bends in the fiber cable. Toshiba recommend that, if the cable must be bent during installation, the bent section should have as large a radius as possible (six to ten times the minimum bending radius). Some fiber-optic connectors are vertical connectors. When inserting a fiber-optic connector, note the directionality of the connection. When coupling or decoupling a fiber optic connector, be sure to hold the connector itself. Do not decouple a fiber-optic connector by pulling on the optical-fiber cord.

(10) Assembling Fiber-Optic Connectors

Since specialized assembly tools are available for the fiber-optic connectors used with TOSLINK devices, people without specialist knowledge can assemble the connectors.

However, the person who assembled the product is responsible for its characteristics and quality.

When a connector is to be used in an application where reliability is essential, Toshiba recommends purchasing a pre-assembled product or contacting a specialist with the necessary expertise.

(11) Absolute Maximum Ratings

The absolute maximum ratings must never be exceeded, even momentarily. Even a single rating value must never be exceeded. The nature of the absolute maximum ratings depend on the product but generally include such parameters as the input and output currents, input voltage, storage temperature, operating temperature and lead temperature.

If the input current or voltage exceeds the absolute maximum rating value, overvoltage and overcurrent can adversely affect the internal circuitry of the device. If the rating is grossly exceeded, the wiring may fuse due to heating in the internal circuits, or the circuitry in the semiconductor chips may be destroyed.

If, for example, the absolute maximum operating temperature, storage temperature or soldering temperature rating is exceeded, the differences in the coefficients of thermal expansion of the various materials that make up the device can damage the sealing or open up bonded parts. When using TOSLINK devices, never exceed any of the absolute maximum ratings.

(12) Recommended Operating Conditions

The recommended operating conditions are conditions recommended to ensure the operation described in the individual datasheets. To improve the reliability of a device even further, use the device with a derated maximum voltage, current, temperature or other parameter. Note that the recommended operating conditions are intended to guarantee the stated operation and do not always guarantee characteristic values.

(13) Smoke and Fire

Since optical modules, connectors and fiber cables are flammable, scorching or burning them may cause them to emit smoke or burst into flame, which can in turn cause gas emissions. Therefore, do not use these devices in the vicinity of flames, smoke or any flammable materials.

(14) Disposal Precautions

TOSLINK devices and packaging materials must be disposed of by the user as industrial waste products in an environmentally appropriate way and in accordance with the law.

(15) Application Precautions

While Toshiba strives to improve the quality and reliability of their products, semiconductor products in general can malfunction or break down. When using a Toshiba semiconductor product, it is the purchaser's responsibility to design safe equipment which does not cause loss of life, injury or damage to property.

When incorporating a Toshiba device into a product, check the latest product specifications of the Toshiba device and ensure that all parameters remain within the absolute maximum ratings and recommended operating condition ranges. In addition, follow the stipulations in Precautions for Handling Toshiba Semiconductor Products and the Toshiba Semiconductor Reliability Handbook, with regard to the precautions and conditions described in those document.

**Toshiba America
Electronic Components, Inc.**

Headquarters-Irvine, CA
9775 Toledo Way, Irvine, CA 92618, U.S.A.
Tel: (949)455-2000 Fax: (949)859-3963

Boulder, CO (Denver)
3100 Araphahoe Avenue, Ste. 500,
Boulder, CO 80303, U.S.A.
Tel: (303)442-3801 Fax: (303)442-7216

Wellington
PBM 337, SUITE 22, 11924 Forest Hill Blvd.,
Wellington, FL 33414
Tel: (561)733-4949 Fax: (561)753-1489

Deerfield, IL (Chicago)
One Pkwy., North, Suite 500, Deerfield,
IL 60015, U.S.A.
Tel: (847)945-1500 Fax: (847)945-1044

Duluth, GA (Atlanta)
3700 Crestwood Parkway, Ste. 460,
Duluth, GA 30196, U.S.A.
Tel: (770)931-3363 Fax: (770)931-7602

Edison, NJ
2035 Lincoln Hwy. #3000, Edison,
NJ 08817, U.S.A.
Tel: (732)248-8070 Fax: (732)248-8030

Portland, OR
1700 NW 167th Place, #240,
Beaverton, OR 97006, U.S.A.
Tel: (503)629-0818 Fax: (503)629-0827

Raleigh, NC
5511 Capital Center Dr., #114,
Raleigh, NC 27606, U.S.A.
Tel: (919)859-2800 Fax: (919)859-2898

Richardson, TX (Dallas)
777 East Campbell Rd., #650, Richardson,
TX 75081, U.S.A.
Tel: (972)480-0470 Fax: (972)235-4114

San Jose Engineering Center, CA
1060 Rincon Circle, San Jose, CA 95131, U.S.A.
Tel: (408)526-2400 Fax: (408)456-2410

Wakefield, MA (Boston)
401 Edgewater Place, #360, Wakefield,
MA 01880, U.S.A.
Tel: (781)224-0074 Fax: (781)224-1095

Toshiba Do Brasil, S.A.

Electronic Component Div.
Estrada Dos Alvarengas 5500,
09850-550, Brasil São Bernardo do campo, S.P.
Tel: (011)4358-7171 Fax: (011)4358-7179

Toshiba Electronics Europe GmbH

Düsseldorf Head Office
Hansaallee 181, D-40549 Düsseldorf,
Germany
Tel: (0211)5296-0 Fax: (0211)5296-400

München Office
Büro München Hofmannstrasse 52,
D-81379, München, Germany
Tel: (089)748595-0 Fax: (089)748595-42

Toshiba Electronics France S.A.R.L.
Immeuble Robert Schuman 3 Rue de Rome
F-93561, Rosny-Sous-Bois, Cédex, France
Tel: (1)48-12-48-12 Fax: (1)48-94-51-15

Toshiba Electronics Italiana S.R.L.
Centro Direzionale Colleoni,
Palazzo Perseo 3,
1-20041 Agrate Brianza, (Milan), Italy
Tel: (039)68701 Fax: (039)6870205

Toshiba Electronics España, S.A.
Parque Empresarial, San Fernando, Edificio Europa,
1ª Planta, E-28831 Madrid, Spain
Tel: (91)660-6798 Fax: (91)660-6799

Toshiba Electronics (UK) Ltd.
Riverside Way, Camberley Surrey,
GU15 3YA, U.K.
Tel: (01276)69-4600 Fax: (01276)69-4800

Toshiba Electronics Scandinavia A.B.
Gustavslundsvägen 12, 2nd Floor,
S-161 15 Bromma, Sweden
Tel: (08)704-0900 Fax: (08)80-8459

**Toshiba Electronics Asia
(Singapore) Pte. Ltd.**

Singapore Head Office
438B Alexandra Road, #06-08/12 Alexandra
Technopark, Singapore 119968
Tel: (6278)5252 Fax: (6271)5155

Bangkok Office
135 Moo 5, Bangkadi Industrial Park, Tivanon Rd.,
Bangkadi, Amphur Muang, Pathumthai, Bangkok 12000,
Thailand
Tel: (02)501-1635 Fax: (02)501-1638

**Toshiba Electronics Trading
(Malaysia) Sdn. Bhd.**

Kuala Lumpur Head Office
Suite W1203, Wisma Conplant, No.2,
Jalan SS 16/4, Subang Jaya, 47500 Petaling Jaya,
Selangor Darul Ehsan, Malaysia
Tel: (03)5631-6311 Fax: (03)5631-6307

Penang Office
Suite 13-1, 13th Floor, Menara Penang Garden,
42-A, Jalan Sultan Ahmad Shah,
100 50 Penang, Malaysia
Tel: (04)226-8523 Fax: (04)226-8515

Toshiba Electronics Philippines, Inc.
26th Floor, Citibank Tower, Valero Street, Makati,
Manila, Philippines
Tel: (02)750-5510 Fax: (02)750-5511

Toshiba Electronics Asia, Ltd.

Hong Kong Head Office
Level 11, Tower 2, Grand Century
Place, No.193, Prince Edward Road West,
Mong Kok, Kowloon, Hong Kong
Tel: 2375-6111 Fax: 2375-0969

Beijing Office
Rm 714, Beijing Fortune Building,
No.5 Dong San Huan Bei-Lu, Chao Yang District,
Beijing, 100004, China
Tel: (010)6590-8796 Fax: (010)6590-8791

Chengdu Office
Suite 403A, Holiday Inn Crown Plaza 31, Zongfu Street,
Chengdu, 610016, China
Tel: (028)675-1773 Fax: (028)675-1065

Shenzhen Office
Rm 3010-3013, Office Tower Shun Hing Square,
Di Wang Commercial Centre, 5002 ShenNan
East Road, Shenzhen, 518008, China
Tel: (0755)246-3218 Fax: (0755)246-1581

Toshiba Electronics Korea Corporation

Seoul Head Office
14/F, KEC B/D, 275-7 Yangjae-dong,
Seocho-ku, Seoul, Korea
Tel: (02)589-4300 Fax: (02)589-4302

Gumi Office
6/F, Good morning Securities B/D,
56 Songjuong-dong, Gumi-shi,
Kyeongbuk, Korea
Tel: (0546)456-7613 Fax: (0546)456-7617

**Toshiba Technology Development
(Shanghai) Co., Ltd.**

23F, HSBC Tower, 101
Yin Cheng East Road, Pudong New Area, Shanghai,
200120, China
Tel: (021)6841-0666 Fax: (021)6841-5002

**Tsurong Xiamen Xiangyu Trading
Co., Ltd.**

8N, Xiamen SEZ Bonded Goods Market Building,
Xiamen, Fujian, 361006, China
Tel: (0592)562-3798 Fax: (0592)562-3799

**Toshiba Electronics Taiwan
Corporation**

Taipei Head Office
17F, Union Enterprise Plaza Bldg. 109
Min Sheng East Rd., Section 3, 105 Taipei,
Taiwan
Tel: (02)2514-9988 Fax: (02)2514-7892

Kaohsiung Office
16F-A, Chung-Cheng Bldg.2, Chung-Cheng 3Rd.,
Kaohsiung, 80027, Taiwan
Tel: (07)237-0826 Fax: (07)236-0046

(As of May, 2002)

The information contained herein is subject to change without notice.

The information contained herein is presented only as a guide for the applications of our products. No responsibility is assumed by TOSHIBA for any infringements of patents or other rights of the third parties which may result from its use. No license is granted by implication or otherwise under any patent or patent rights of TOSHIBA or others.

TOSHIBA is continually working to improve the quality and reliability of its products. Nevertheless, semiconductor devices in general can malfunction or fail due to their inherent electrical sensitivity and vulnerability to physical stress. It is the responsibility of the buyer, when utilizing TOSHIBA products, to comply with the standards of safety in making a safe design for the entire system, and to avoid situations in which a malfunction or failure of such TOSHIBA products could cause loss of human life, bodily injury or damage to property. In developing your designs, please ensure that TOSHIBA products are used within specified operating ranges as set forth in the most recent TOSHIBA products specifications. Also, please keep in mind the precautions and conditions set forth in the "Handling Guide for Semiconductor Devices," or "TOSHIBA Semiconductor Reliability Handbook" etc..

The Toshiba products listed in this document are intended for usage in general electronics applications (computer, personal equipment, office equipment, measuring equipment, industrial robotics, domestic appliances, etc.). These Toshiba products are neither intended nor warranted for usage in equipment that requires extraordinarily high quality and/or reliability or a malfunction or failure of which may cause loss of human life or bodily injury ("Unintended Usage"). Unintended Usage include atomic energy control instruments, airplane or spaceship instruments, transportation instruments, traffic signal instruments, combustion control instruments, medical instruments, all types of safety devices, etc.. Unintended Usage of Toshiba products listed in this document shall be made at the customer's own risk.

Gallium arsenide (GaAs) is a substance used in some of the products described in this documents. GaAs dust and fumes are toxic. Do not break, cut or pulverize the products, or use chemicals to dissolve them. When disposing of the products, follow the appropriate regulations. Do not dispose of the products with other industrial waste or with domestic garbage. The products described in this document may include products subject to the foreign exchange and foreign trade laws.

Website: <http://www.semicon.toshiba.co.jp/eng/index.html>

3655C-0207 PC-DQ

TOSHIBA**TOSHIBA CORPORATION****Electronic Devices Sales & Marketing Division**

1-1, Shibaura 1-chome, Minato-ku, Tokyo, 105-8001, Japan
Tel: +81-3-3457-3406 Fax: +81-3-5444-9431
E-mail: semicon@toshiba.co.jp