

Thick film rectangular

MCR25 (3225 size: 1 / 4W)

●Features

- 1) Made of same material as the general purpose chip resistors (MCR10 / 18).
- 2) Highly reliable chip resistor
Ruthenium oxide resistive material offers superior resistance to the elements.
- 3) Electrodes not corroded by soldering
Suitable for re-flow soldering.
- 4) ROHM resistors have approved ISO-9001 certification.
Design and specifications are subject to change without notice. Carefully check the specification sheet before using or ordering it.

●Ratings

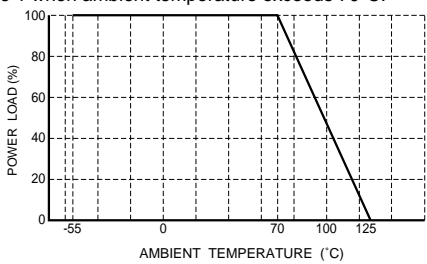
Item	Conditions	Specifications
Rated power	Power must be derated according to the power derating curve in Figure 1 when ambient temperature exceeds 70°C.  <p style="text-align: center;">Fig.1</p>	0.25W (1 / 4W) at 70°C
Rated voltage	The voltage rating is calculated by the following equation. If the value obtained exceeds the limiting element voltage, the voltage rating is equal to the maximum operating voltage. $E = \sqrt{P \times R}$ <div style="display: flex; justify-content: space-between; margin-top: 5px;"> <div>E: Rated voltage (V)</div> <div>P: Rated power (W)</div> <div>R: Nominal resistance (Ω)</div> </div>	Limiting element voltage 200V
Nominal resistance	See Table 1 .	
Operating temperature		-55°C to +125°C

Jumper type

Resistance	Max. 50mΩ
Rated current	2A
Operating temperature	-55°C to +125°C

Table 1

Resistance tolerance	Resistance range (Ω)	Resistance temperature coefficient (ppm/°C)
F (±1%)	10 ≤ R ≤ 1M (E24,96)	±100
J (±5%)	1.0 ≤ R < 2.2 (E24)	500±350
	2.2 ≤ R < 5.6 (E24)	±500
	5.6 ≤ R ≤ 3.3M (E24)	±200

●Before using components in circuits where they will be exposed to transients such as pulse loads (short-duration, high-level loads), be certain to evaluate the component in the mounted state. In addition, the reliability and performance of this component cannot be guaranteed if it is used with a steady state voltage that is greater than its rated voltage.

Resistors

●Characteristics

Item	Guaranteed value		Test conditions (JIS C 5201-1)
	Resistor type	Jumper type	
Resistance	J : $\pm 5\%$ F : $\pm 1\%$	Max. 50m Ω	JIS C 5201-1 4.5
Variation of resistance with temperature	See Table.1		JIS C 5201-1 4.8 Measurement : $-55 / +25 / +125^{\circ}\text{C}$
Overload	$\pm (2.0\%+0.1\Omega)$	Max. 50m Ω	JIS C 5201-1 4.13 Rated voltage (current) $\times 2.5$, 2s. Limiting Element Voltage $\times 2$: 400V
Solderability	A new uniform coating of minimum of 95% of the surface being immersed and no soldering damage.		JIS C 5201-1 4.17 Rosin-Ethanol (25%WT) Soldering condition : $235\pm 5^{\circ}\text{C}$ Duration of immersion : $2.0\pm 0.5\text{s}$.
Resistance to soldering heat	$\pm (1.0\%+0.05\Omega)$ No remarkable abnormality on the appearance.	Max. 50m Ω	JIS C 5201-1 4.18 Soldering condition : $260\pm 5^{\circ}\text{C}$ Duration of immersion : $10\pm 1\text{s}$.
Rapid change of temperature	$\pm (1.0\%+0.05\Omega)$	Max. 50m Ω	JIS C 5201-1 4.19 Test temp. : -55°C to $+125^{\circ}\text{C}$ 5cyc
Damp heat, steady state	$\pm (3.0\%+0.1\Omega)$	Max. 100m Ω	JIS C 5201-1 4.24 40°C , 93%RH Test time : 1,000h to 1,048h
Endurance at 70°C	$\pm (3.0\%+0.1\Omega)$	Max. 100m Ω	JIS C 5201-1 4.25.1 Rated voltage (current), 70°C 1.5h : ON – 0.5h : OFF Test time : 1,000h to 1,048h
Endurance	$\pm (3.0\%+0.1\Omega)$	Max. 100m Ω	JIS C 5201-1 4.25.3 125°C Test time : 1,000h to 1,048h
Resistance to solvent	$\pm (1.0\%+0.05\Omega)$	Max. 50m Ω	JIS C 5201-1 4.29 $23\pm 5^{\circ}\text{C}$, Immersion cleaning, $5\pm 0.5\text{min}$. Solvent : 2-propanol
Bend strength of the end face plating	$\pm (1.0\%+0.05\Omega)$ Without mechanical damage such as breaks.	Max. 50m Ω	JIS C 5201-1 4.33

●External dimensions (Unit : mm)

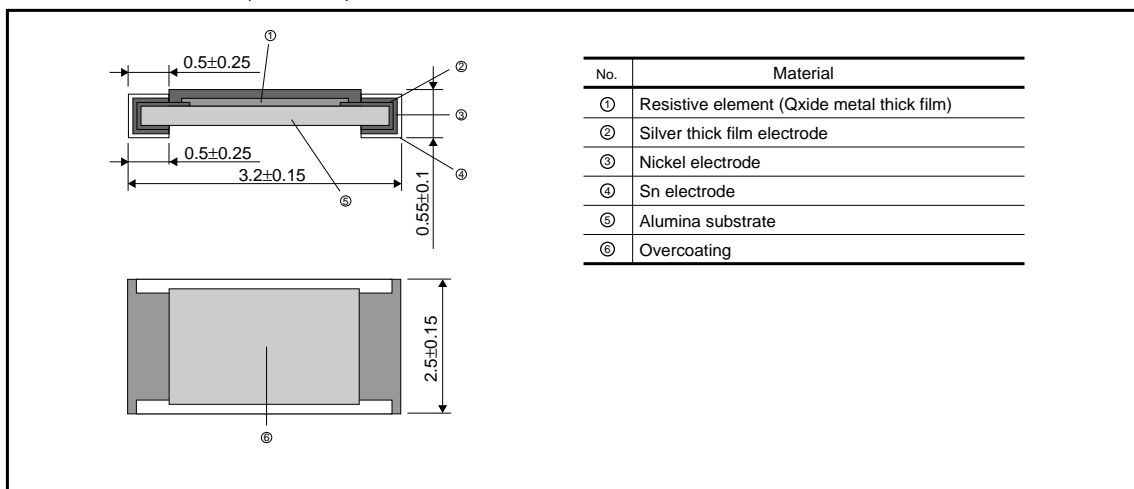

Resistors

●Packaging

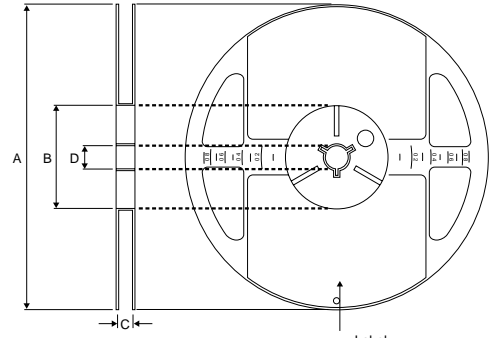
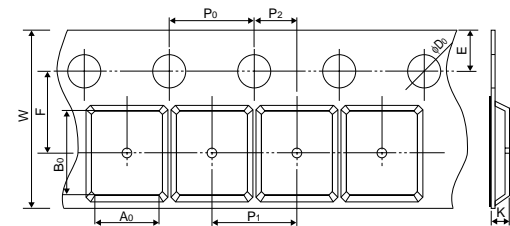
Reel	Taping																												
 <p style="text-align: center;">Label EIAJ ET-7200B compliant</p> <p style="text-align: center;">(Unit : mm)</p> <table border="1" style="margin-left: auto; margin-right: auto;"> <tr> <td style="text-align: center;">A</td> <td style="text-align: center;">B</td> <td style="text-align: center;">C</td> <td style="text-align: center;">D</td> </tr> <tr> <td style="text-align: center;">$\phi 180 \begin{smallmatrix} 0 \\ -1.5 \end{smallmatrix}$</td> <td style="text-align: center;">$\phi 60 \begin{smallmatrix} +1 \\ 0 \end{smallmatrix}$</td> <td style="text-align: center;">$9 \begin{smallmatrix} +1.0 \\ 0 \end{smallmatrix}$</td> <td style="text-align: center;">$\phi 13 \pm 0.2$</td> </tr> </table>	A	B	C	D	$\phi 180 \begin{smallmatrix} 0 \\ -1.5 \end{smallmatrix}$	$\phi 60 \begin{smallmatrix} +1 \\ 0 \end{smallmatrix}$	$9 \begin{smallmatrix} +1.0 \\ 0 \end{smallmatrix}$	$\phi 13 \pm 0.2$	 <p style="text-align: right;">(Unit : mm)</p> <table border="1" style="margin-left: auto; margin-right: auto;"> <tr> <td style="text-align: center;">W</td> <td style="text-align: center;">F</td> <td style="text-align: center;">E</td> <td style="text-align: center;">A₀</td> <td style="text-align: center;">B₀</td> </tr> <tr> <td style="text-align: center;">8.0 ± 0.3</td> <td style="text-align: center;">3.5 ± 0.05</td> <td style="text-align: center;">1.75 ± 0.1</td> <td style="text-align: center;">3.0 ± 0.1</td> <td style="text-align: center;">3.5 ± 0.1</td> </tr> <tr> <td style="text-align: center;">D₀</td> <td style="text-align: center;">P₀</td> <td style="text-align: center;">P₁</td> <td style="text-align: center;">P₂</td> <td style="text-align: center;">K</td> </tr> <tr> <td style="text-align: center;">$\phi 1.5 \begin{smallmatrix} +0.1 \\ 0 \end{smallmatrix}$</td> <td style="text-align: center;">4.0 ± 0.1</td> <td style="text-align: center;">4.0 ± 0.1</td> <td style="text-align: center;">2.0 ± 0.05</td> <td style="text-align: center;">Max. 1.1</td> </tr> </table>	W	F	E	A ₀	B ₀	8.0 ± 0.3	3.5 ± 0.05	1.75 ± 0.1	3.0 ± 0.1	3.5 ± 0.1	D ₀	P ₀	P ₁	P ₂	K	$\phi 1.5 \begin{smallmatrix} +0.1 \\ 0 \end{smallmatrix}$	4.0 ± 0.1	4.0 ± 0.1	2.0 ± 0.05	Max. 1.1
A	B	C	D																										
$\phi 180 \begin{smallmatrix} 0 \\ -1.5 \end{smallmatrix}$	$\phi 60 \begin{smallmatrix} +1 \\ 0 \end{smallmatrix}$	$9 \begin{smallmatrix} +1.0 \\ 0 \end{smallmatrix}$	$\phi 13 \pm 0.2$																										
W	F	E	A ₀	B ₀																									
8.0 ± 0.3	3.5 ± 0.05	1.75 ± 0.1	3.0 ± 0.1	3.5 ± 0.1																									
D ₀	P ₀	P ₁	P ₂	K																									
$\phi 1.5 \begin{smallmatrix} +0.1 \\ 0 \end{smallmatrix}$	4.0 ± 0.1	4.0 ± 0.1	2.0 ± 0.05	Max. 1.1																									

●Makeup of the part number

M	C	R	2	5	J	Z	H	J																		
Part No.			Resistance tolerance		Nominal resistance																					
			<table border="1" style="font-size: small;"> <tr><td>F</td><td>$\pm 1\%$</td></tr> <tr><td>J</td><td>$\pm 5\%$</td></tr> <tr><td colspan="2">J is also used for jumper</td></tr> </table>		F	$\pm 1\%$	J	$\pm 5\%$	J is also used for jumper		<table border="1" style="font-size: small;"> <tr><td colspan="2">Resistance code, 3 or 4 digits. 000 denotes jumper type.</td></tr> <tr> <td>Resistance tolerance</td> <td>Resistance code</td> </tr> <tr> <td>F</td> <td>: 4 digits</td> </tr> <tr> <td>J</td> <td>: 3 digits</td> </tr> </table>								Resistance code, 3 or 4 digits. 000 denotes jumper type.		Resistance tolerance	Resistance code	F	: 4 digits	J	: 3 digits
F	$\pm 1\%$																									
J	$\pm 5\%$																									
J is also used for jumper																										
Resistance code, 3 or 4 digits. 000 denotes jumper type.																										
Resistance tolerance	Resistance code																									
F	: 4 digits																									
J	: 3 digits																									

Packaging / Processing specifications

Part No.	Code	Packaging	Standard ordering unit (pcs)
MCR25	JZH	Paper tape	4,000

●Dimensions

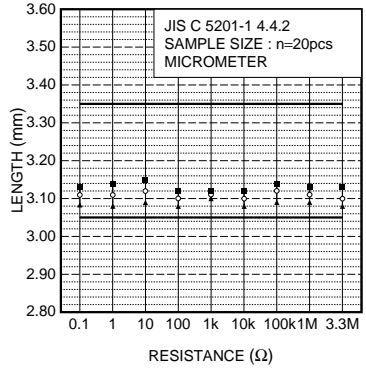

Fig.2 Dimensions (length)

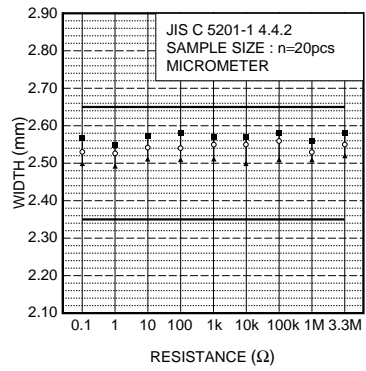

Fig.3 Dimensions (width)

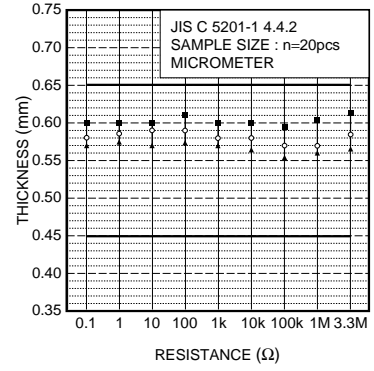

Fig.4 Dimensions (thickness)

Resistors

●Electrical characteristics

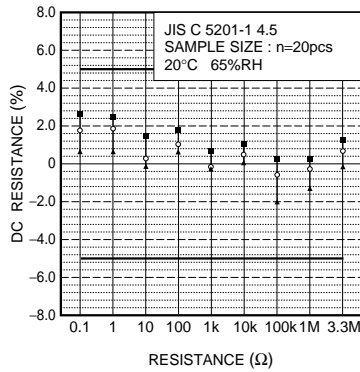

Fig.5 Resistance

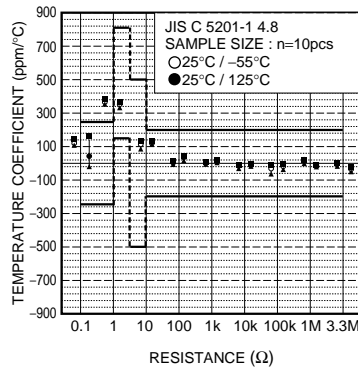

Fig.6 Variation resistance with temperature

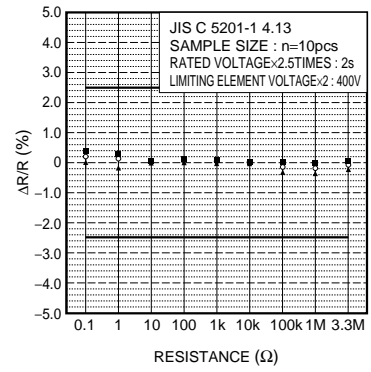

Fig.7 Overload

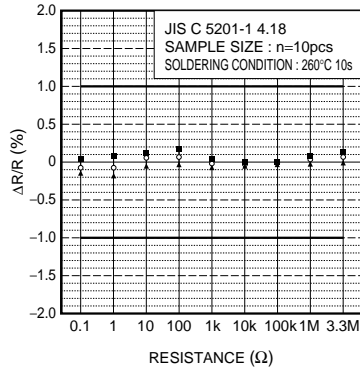

Fig.8 Resistance to soldering heat

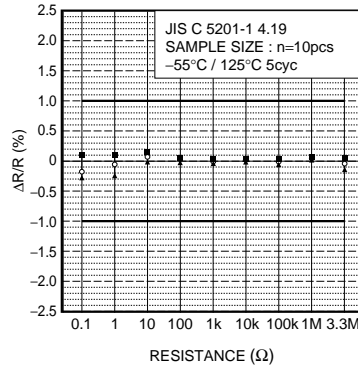

Fig.9 Rapid change of temperature

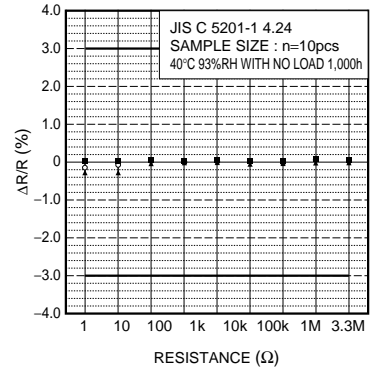

Fig.10 Damp heat, steady state

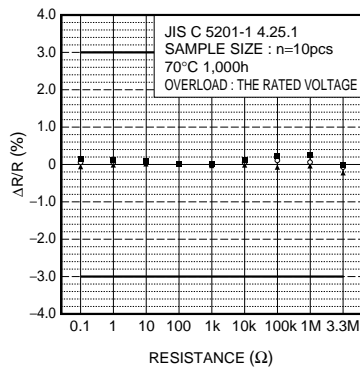

Fig.11 Endurance at 70°C

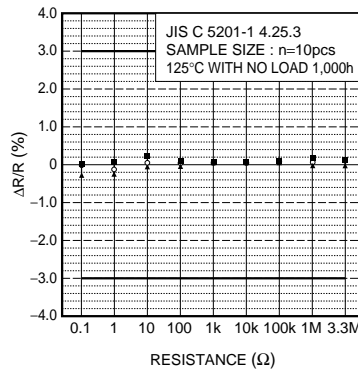

Fig.12 Endurance

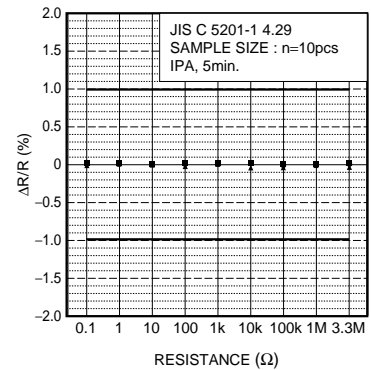

Fig.13 Resistance to solvents

Resistors

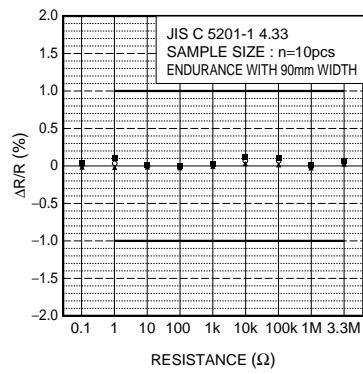

Fig.14 Bend strength of
the end face plating

Notes

- No technical content pages of this document may be reproduced in any form or transmitted by any means without prior permission of ROHM CO.,LTD.
- The contents described herein are subject to change without notice. The specifications for the product described in this document are for reference only. Upon actual use, therefore, please request that specifications to be separately delivered.
- Application circuit diagrams and circuit constants contained herein are shown as examples of standard use and operation. Please pay careful attention to the peripheral conditions when designing circuits and deciding upon circuit constants in the set.
- Any data, including, but not limited to application circuit diagrams information, described herein are intended only as illustrations of such devices and not as the specifications for such devices. ROHM CO.,LTD. disclaims any warranty that any use of such devices shall be free from infringement of any third party's intellectual property rights or other proprietary rights, and further, assumes no liability of whatsoever nature in the event of any such infringement, or arising from or connected with or related to the use of such devices.
- Upon the sale of any such devices, other than for buyer's right to use such devices itself, resell or otherwise dispose of the same, no express or implied right or license to practice or commercially exploit any intellectual property rights or other proprietary rights owned or controlled by
- ROHM CO., LTD. is granted to any such buyer.
- Products listed in this document are no antiradiation design.

The products listed in this document are designed to be used with ordinary electronic equipment or devices (such as audio visual equipment, office-automation equipment, communications devices, electrical appliances and electronic toys).

Should you intend to use these products with equipment or devices which require an extremely high level of reliability and the malfunction of which would directly endanger human life (such as medical instruments, transportation equipment, aerospace machinery, nuclear-reactor controllers, fuel controllers and other safety devices), please be sure to consult with our sales representative in advance.

About Export Control Order in Japan

Products described herein are the objects of controlled goods in Annex 1 (Item 16) of Export Trade Control Order in Japan.

In case of export from Japan, please confirm if it applies to "objective" criteria or an "informed" (by MITI clause) on the basis of "catch all controls for Non-Proliferation of Weapons of Mass Destruction.