

Thick film rectangular

MCR006 (0201 size : 1 / 20W)

●Features

- 1) Extremely small light
Area ratio is 60% smaller than that of chip 1005, while weight ratio has been cut 80%.
- 2) Highly reliable chip resistor
Ruthenium oxide dielectric offers superior resistance to the elements.
- 3) Electrodes not corroded by soldering
Thick film makes the electrodes very strong.
- 4) Flat surface further facilitates mounting
- 5) ROHM resistors have approved ISO-9001 certification.
Design and specifications are subject to change without notice. Carefully check the specification sheet supplied with the product before using or ordering it.

●Ratings

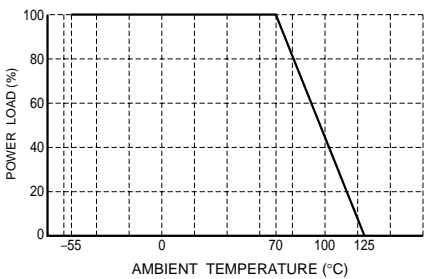
Item	Conditions	Specifications		
Rated power	<p>Power must be derated according to the power derating curve in Figure 1 when ambient temperature exceeds 70°C.</p>  <p style="text-align: center;">Fig.1</p>	0.05W (1 / 20W) at 70°C		
Rated voltage	<p>The voltage rating is calculated by the following equation. If the value obtained exceeds the limiting element voltage, the voltage rating is equal to the maximum operating voltage.</p> $E = \sqrt{P \times R}$ <p style="text-align: center;"> E: Rated voltage (V) P: Rated power (W) R: Nominal resistance (Ω) </p>	<table border="1" style="width: 100%;"> <tr> <td style="width: 80%;">Limiting element voltage</td> <td style="width: 20%;">25V</td> </tr> </table>	Limiting element voltage	25V
Limiting element voltage	25V			
Nominal resistance	See Table 1.			
Operating temperature		-55°C to +125°C		

Resistors

Jumper type

Resistance	Max. 50mΩ
Rated current	0.5A
Operating temperature	-55°C to +125°C

Table 1

Resistance tolerance	Resistance range (Ω)	Resistance temperature coefficient (ppm / °C)
J (±5%)	1.0≤R≤9.1 (E24)	+600/-200
	10≤R≤10M (E24)	±250
F (±1%)	10≤R≤10M (E24)	±250

- Before using components in circuits where they will be exposed to transients such as pulse loads (short-duration, high-level loads), be certain to evaluate the component in the mounted state. In addition, the reliability and performance of this component cannot be guaranteed if it is used with a steady state voltage that is greater than its rated voltage.

● Characteristics

Item	Guaranteed value		Test conditions (JIS C 5201-1)
	Resistor type	Jumper type	
Resistance	J : ±5% F : ±1%	Max. 50mΩ	JIS C 5201-1 4.5
Variation of resistance with temperature	See Table.1	Max. 100mΩ	JIS C 5201-1 4.8 Measurement : +20 / -55 / +125°C
Overload	± (2.0%+0.1Ω)	Max. 50mΩ	JIS C 5201-1 4.13 Rated voltage (current) ×2.5, 2s. Maximum overload voltage : 50V
Solderability	A new uniform coating of minimum of 95% of the surface being immersed and no soldering damage.		JIS C 5201-1 4.17 Rosin-Ethanol (25%WT) Soldering condition : 235±5°C Duration of immersion : 2.0±0.5s.
Resistance to soldering heat	± (1.0%+0.05Ω) No remarkable abnormality on the appearance.	Max. 50mΩ	JIS C 5201-1 4.18 Soldering condition : 260±5°C Duration of immersion : 10±1s.
Rapid change of temperature	± (1.0%+0.05Ω)	Max. 50mΩ	JIS C 5201-1 4.19 Test temp. : -55°C to +125°C 100cyc
Damp heat, steady state	± (3.0%+0.1Ω)	Max. 100mΩ	JIS C 5201-1 4.24 40°C, 93%RH Test time : 1,000h to 1,048h
Endurance at 70°C	± (3.0%+0.1Ω)	Max. 100mΩ	JIS C 5201-1 4.25.1 Rated voltage (current), 70°C±3°C 1.5h : ON - 0.5h : OFF Test time : 1,000h to 1,048h
Endurance	± (3.0%+0.1Ω)	Max. 100mΩ	JIS C 5201-1 4.25.3 125°C Test time : 1,000h to 1,048h
Resistance to solvent	± (1.0%+0.05Ω)	Max. 50mΩ	JIS C 5201-1 4.29 23±5°C, Immersion cleaning, 5±0.5min. Solvent : 2-propanol
Bend strength of the end face plating	± (1.0%+0.05Ω) Without mechanical damage such as breaks.	Max. 50mΩ	JIS C 5201-1 4.33

Resistors

●Dimensions (Unit : mm)

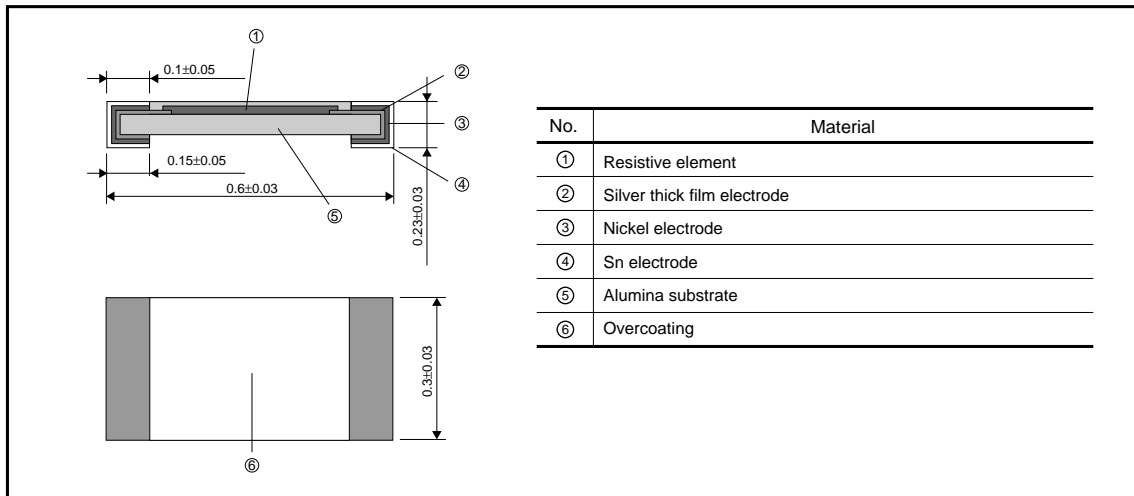

●Packaging

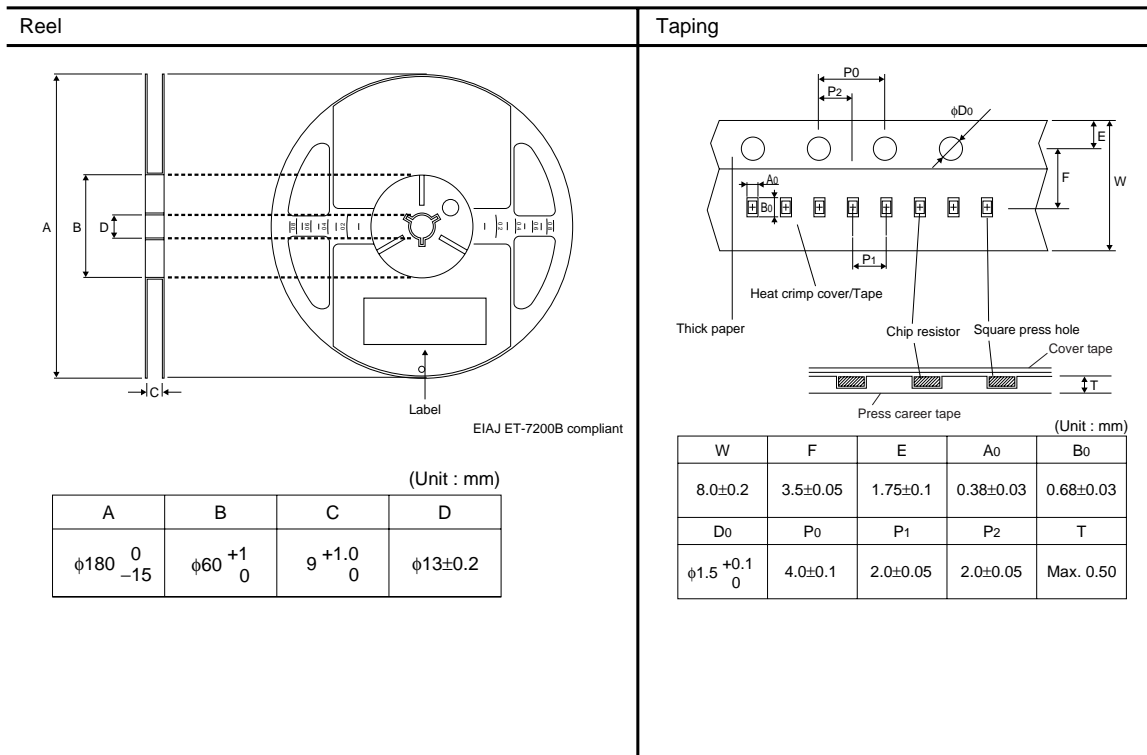

Resistors

●Part No. Explanation

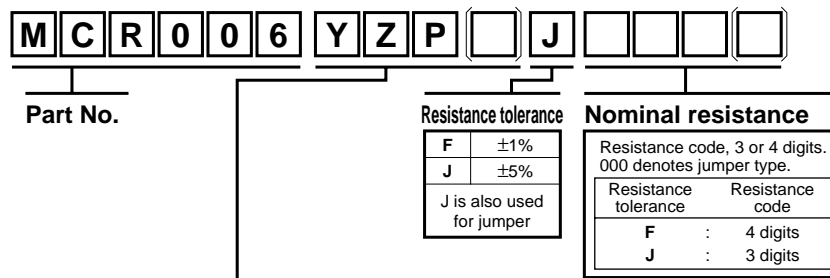

Packaging Specifications Code

Part No.	Code	Resistance tolerance		Packaging specifications	Reel	Basic ordering unit (pcs)
		J(±5%)	F(±1%)			
MCR006	YZP	⊙	⊙	Paper tape (2mm Pitch)	φ180mm (7in.)	15,000

Reel (φ180) : JEITA ET-7200B
 ⊙ : Standard product

●Dimensions

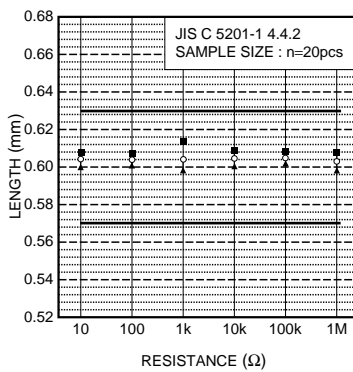

Fig.2 Dimensions (length)

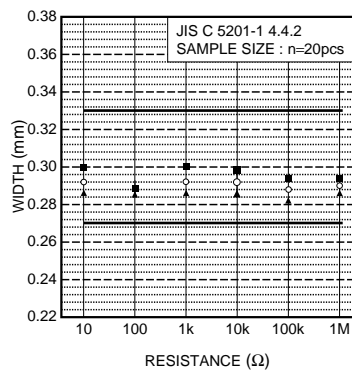

Fig.3 Dimensions (width)

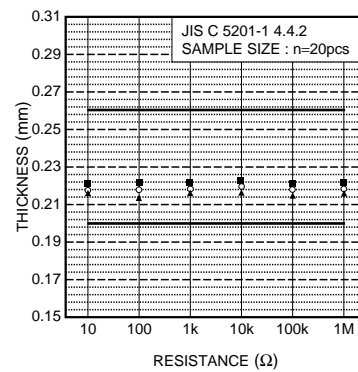

Fig.4 Dimensions (thickness)

●Electrical characteristics

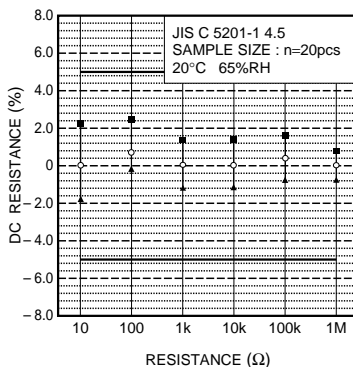

Fig.5 Resistance

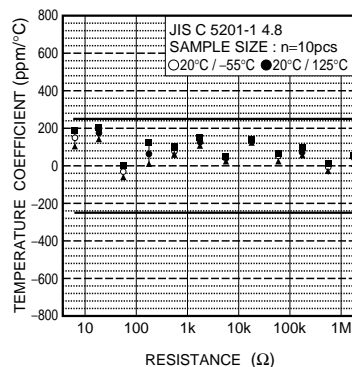

Fig.6 Variation of resistance with temperature

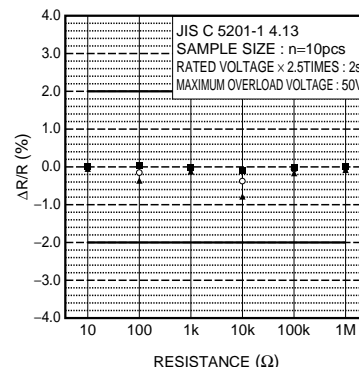

Fig.7 Overload

Resistors

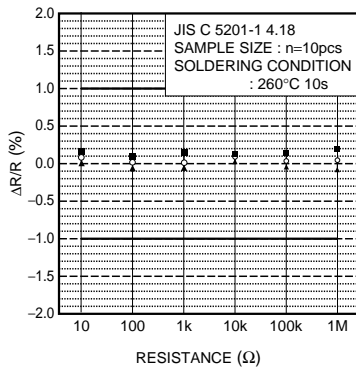

Fig.8 Resistance to soldering heat

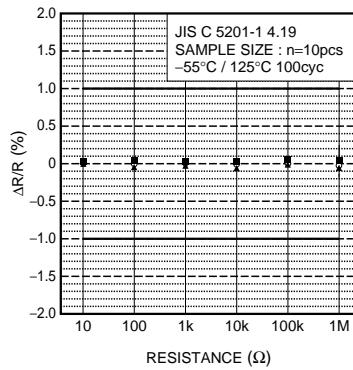

Fig.9 Rapid change of temperature

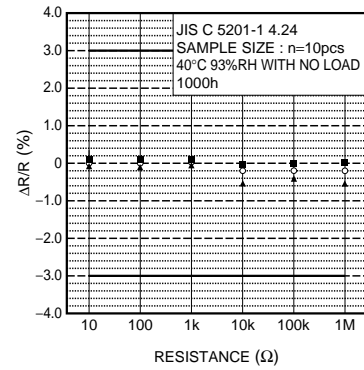

Fig.10 Damp heat, steady state

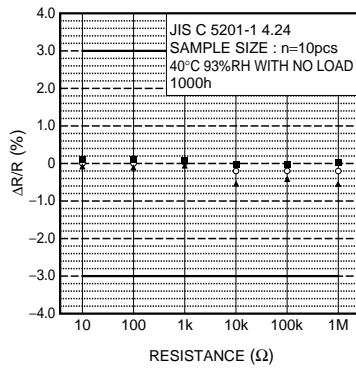

Fig.11 Endurance at 70°C

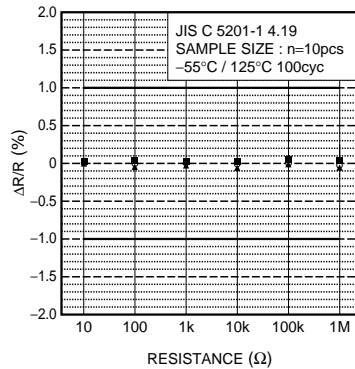

Fig.12 Endurance

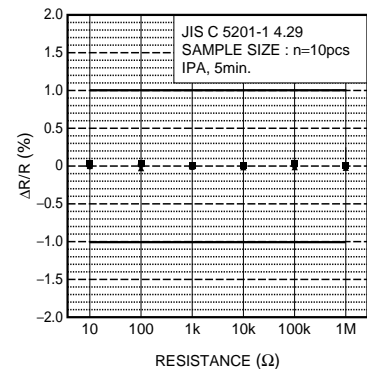

Fig.13 Resistance to solvents

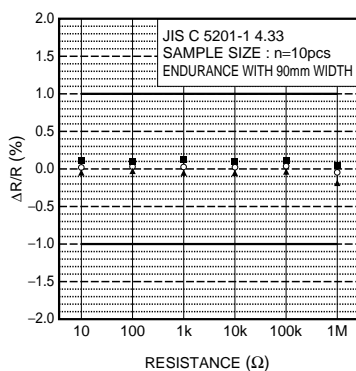

Fig.14 Bend strength of the end face plating

Notes

- No technical content pages of this document may be reproduced in any form or transmitted by any means without prior permission of ROHM CO.,LTD.
- The contents described herein are subject to change without notice. The specifications for the product described in this document are for reference only. Upon actual use, therefore, please request that specifications to be separately delivered.
- Application circuit diagrams and circuit constants contained herein are shown as examples of standard use and operation. Please pay careful attention to the peripheral conditions when designing circuits and deciding upon circuit constants in the set.
- Any data, including, but not limited to application circuit diagrams information, described herein are intended only as illustrations of such devices and not as the specifications for such devices. ROHM CO.,LTD. disclaims any warranty that any use of such devices shall be free from infringement of any third party's intellectual property rights or other proprietary rights, and further, assumes no liability of whatsoever nature in the event of any such infringement, or arising from or connected with or related to the use of such devices.
- Upon the sale of any such devices, other than for buyer's right to use such devices itself, resell or otherwise dispose of the same, no express or implied right or license to practice or commercially exploit any intellectual property rights or other proprietary rights owned or controlled by
- ROHM CO., LTD. is granted to any such buyer.
- Products listed in this document are no antiradiation design.

The products listed in this document are designed to be used with ordinary electronic equipment or devices (such as audio visual equipment, office-automation equipment, communications devices, electrical appliances and electronic toys).

Should you intend to use these products with equipment or devices which require an extremely high level of reliability and the malfunction of which would directly endanger human life (such as medical instruments, transportation equipment, aerospace machinery, nuclear-reactor controllers, fuel controllers and other safety devices), please be sure to consult with our sales representative in advance.

About Export Control Order in Japan

Products described herein are the objects of controlled goods in Annex 1 (Item 16) of Export Trade Control Order in Japan.

In case of export from Japan, please confirm if it applies to "objective" criteria or an "informed" (by MITI clause) on the basis of "catch all controls for Non-Proliferation of Weapons of Mass Destruction.