



Technical Data Sheet

5.0mm Multi-Color Round Type LED Lamps

336EGW

■ Features :

- Two chips are matched for uniform light output, wide viewing angle
- Long life-solid state reliability
- I.C. compatible/Low power consumption
- Pb free

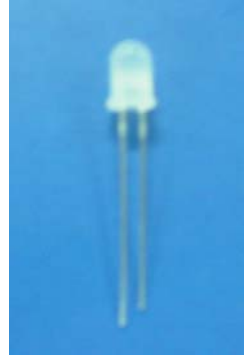

■ Descriptions :

- The 336 LED lamps contain two integral chips and is available as both bicolor and bipolar types.
- The Orange and Green light is emitted by diodes of GaAsP/GaP and GaP respectively.
- Type of bipolar lamps are both White Diffused and Color Diffused while the bicolor are White Diffused.

■ Applications :

- TV set
- Monitor
- Telephone
- Computer

PART NO.	Chip		Lens Color
	Material	Emitted Color	
336EGW	GaAsP/GaP	Orange	White Diffused
	GaP	Green	



Technical Data Sheet

5.0mm Multi-Color Round Type LED Lamps

336EGW

Package Dimensions

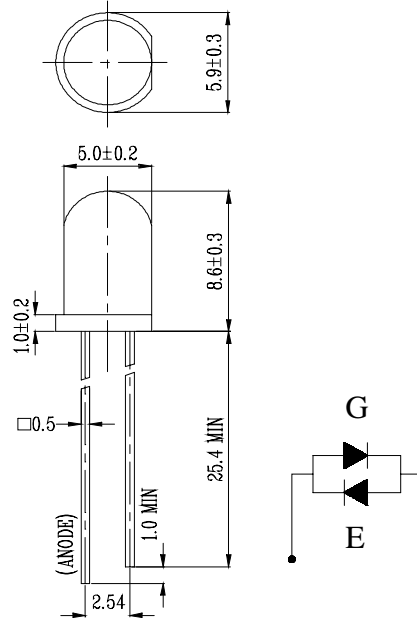

Notes: 1.All dimensions are in millimetres

- 2. An epoxy meniscus may extend about 1.5mm(0.059") down to the lead.
- 3. Tolerances unless Dimension ± 0.25 mm.

Absolute Maximum Ratings at Ta = 25°C

Parameter	Symbol	Rating	Unit
Forward Current	IF	E 30	mA
		G 30	
Operating Temperature	Topr	-40 to +85	°C
Storage Temperature	Tstg	-40 to +100	°C
Soldering Temperature	Tsol	260 ± 5	°C
Power Dissipation	Pd	E 100	mW
		G 100	
Peak Forward Current	IF(Peak)	E 160	mA
		G 160	
Reverse Voltage	VR	5	V

Note: *1:IFP Conditions --Pulse Width \leq 1msec and Duty \leq 1/10.

*2:Soldering time \leq 5 seconds.



Technical Data Sheet
5.0mm Multi-Color Round Type LED Lamps

336EGW

Electro-Optical Characteristics (Ta=25°C)

Parameter	Symbol	Min.	Typ.	Max.	Unit	Condition
Luminous Intensity	Iv E	0.63	2.5	/	mcd	IF= 10 mA
	G	0.63	2.5	/		
Viewing Angle	2θ 1/2	/	54	/	deg	IF= 20 mA
Peak Wavelength	λ p E	/	635	/	nm	IF= 20 mA
	G	/	565	/		
Dominant Wavelength	λ d E	/	625	/	nm	IF= 20 mA
	G	/	570	/		
Spectrum Radiation Bandwidth	Δ λ E	/	45	/	nm	IF= 20 mA
	G	/	30	/		
Forward Voltage	Vf E	1.7	2.0	2.4	V	IF= 20 mA
	G	1.7	2.1	2.4		



Technical Data Sheet

5.0mm Multi-Color Round Type LED Lamps

336EGW

Typical Electro-Optical Characteristic Curves:

(E)

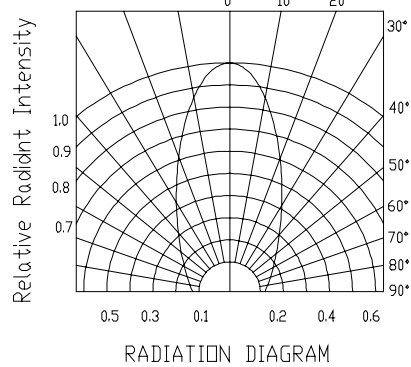
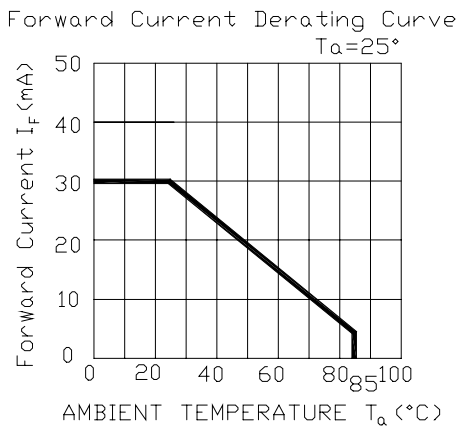
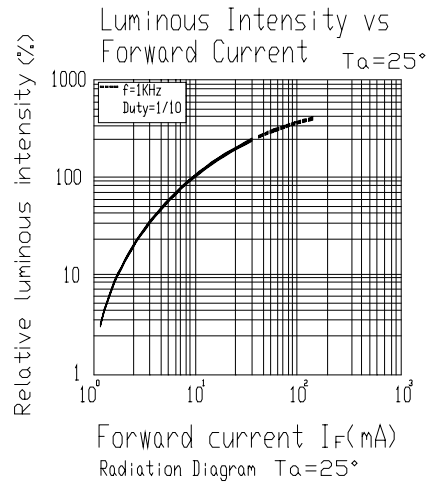
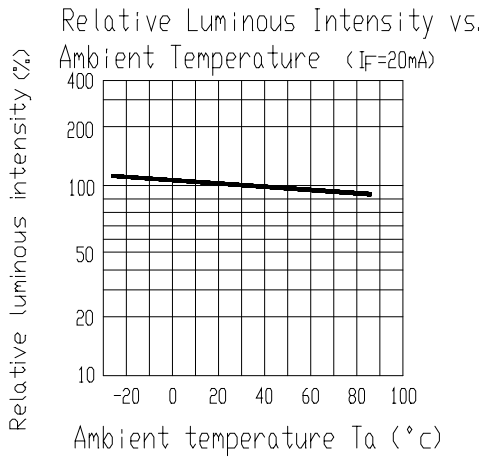
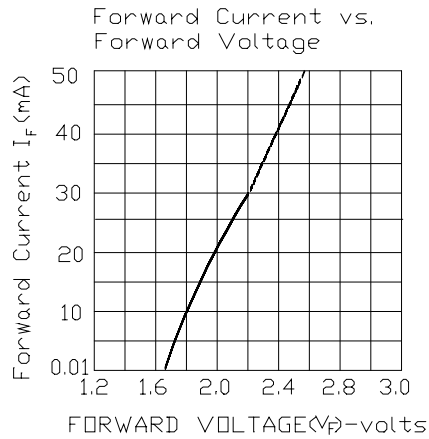
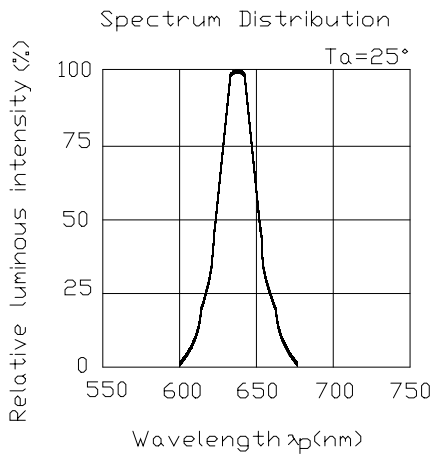



Technical Data Sheet

5.0mm Multi-Color Round Type LED Lamps

336EGW

Typical Electro-Optical Characteristic Curves:

(G)

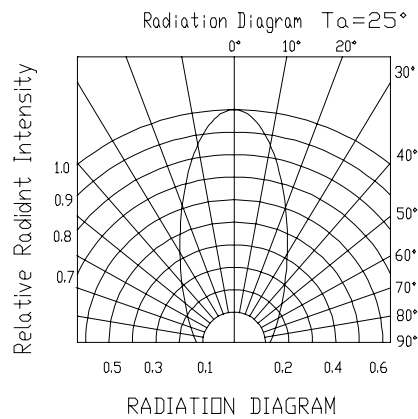
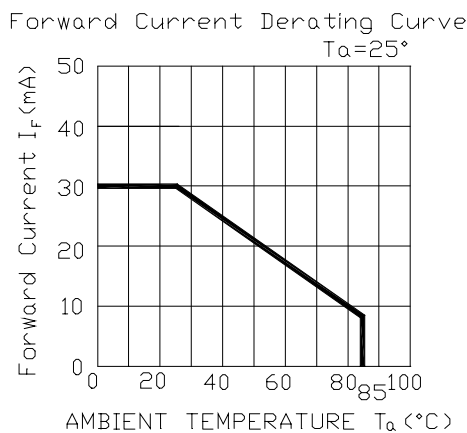
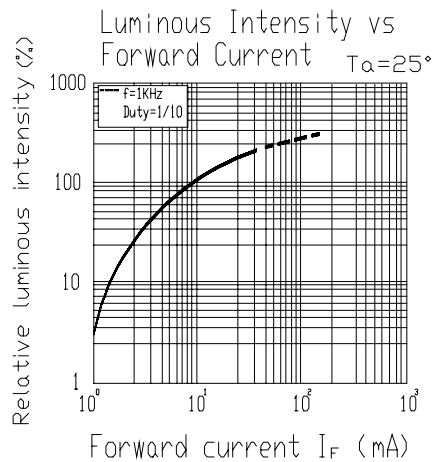
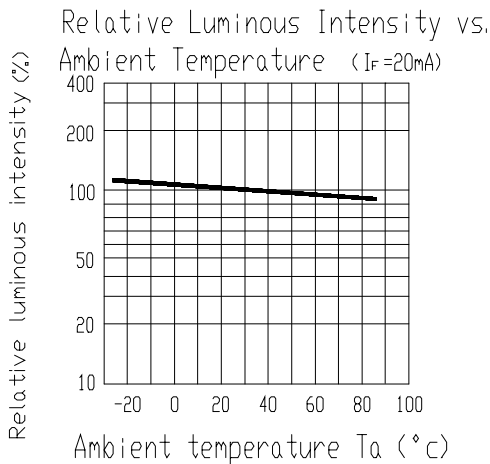
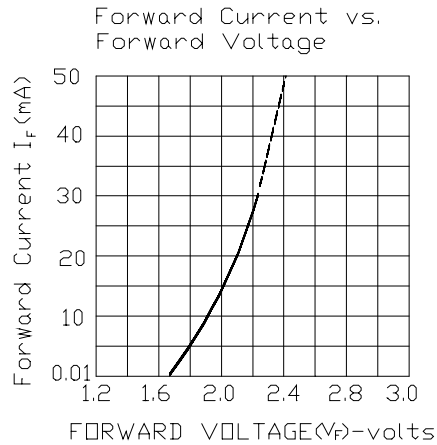
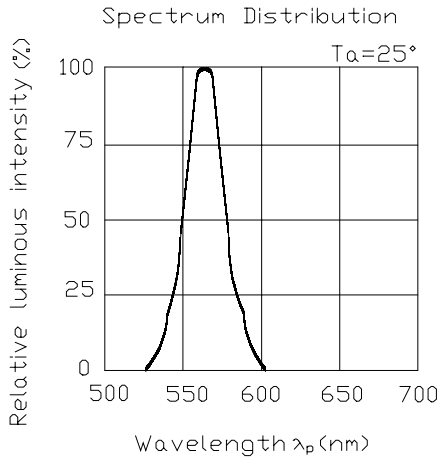



Technical Data Sheet

5.0mm Multi-Color Round Type LED Lamps

336EGW

■ Reliability test items and conditions:

NO	Item	Test Conditions	Test Hours/Cycle	Sample Size	Ac/Re
1	Solder Heat	TEMP : 260°C ± 5 °C	10 SEC	76 PCS	0/1
2	Temperature Cycle	H : +100°C 15min ∫ 5 min L : -40°C 15min	300 CYCLES	76 PCS	0/1
3	Thermal Shock	H : +100°C 5min ∫ 10 sec L : -10°C 5min	300 CYCLES	76 PCS	0/1
4	High Temperature Storage	TEMP : 100°C	1000 HRS	76 PCS	0/1
5	Low Temperature Storage	TEMP : -40°C	1000 HRS	76 PCS	0/1
6	DC Operating Life	TEMP : 25°C IF=20mA	1000 HRS	76 PCS	0/1
7	High Temperature / High Humidity	85°C / 85% RH	1000 HRS	76 PCS	0/1



Technical Data Sheet

5.0mm Multi-Color Round Type LED Lamps

336EGW

Packing Quantity Specification

1.500PCS/1Bag , 5Bags/1Box

2.10Boxes/1Carton

Label Form Specification

EVERLIGHT

CPN:

P/N:



336EGW

QTY:



CAT:

HUE:

REF:

LOT NO: EL



MADE IN TAIWAN

CPN: Customer's Production Number

P/N : Production Number

QTY: Packing Quantity

CAT: Ranks

HUE: Peak Wavelength

REF: Reference

LOT No: Lot Number

MADE IN TAIWAN: Production Place

Notes

1. Above specification may be changed without notice. EVERLIGHT will reserve authority on material change for above specification.
2. When using this product, please observe the absolute maximum ratings and the instructions for using outlined in these specification sheets. EVERLIGHT assumes no responsibility for any damage resulting from use of the product which does not comply with the absolute maximum ratings and the instructions included in these specification sheets.
3. These specification sheets include materials protected under copyright of EVERLIGHT corporation. Please don't reproduce or cause anyone to reproduce them without EVERLIGHT's consent.

EVERLIGHT ELECTRONICS CO., LTD.

Office: No 25, Lane 76, Sec 3, Chung Yang Rd,

Tucheng Tainei 236 Taiwan R O C.

Tel: 886-2-2267-2000, 2267-9936

Fax: 886-2267-6244, 2267-6189, 2267-6306

<http://www.everlight.com>