

74LVX125 Low Voltage Quad Buffer with 3-STATE Outputs

General Description

The LVX125 contains four independent non-inverting buffers with 3-STATE outputs. The inputs tolerate voltages up to 7V allowing the interface of 5V systems to 3V systems.

Features

- Input voltage level translation from 5V to 3V
- Ideal for low power/low noise 3.3V applications
- Guaranteed simultaneous switching noise level and dynamic threshold performance

Ordering Code:

Order Number	Package Number	Package Description
74LVX125M	M14A	14-Lead Small Outline Integrated Circuit (SOIC), JEDEC MS-012, 0.150" Narrow
74LVX125SJ	M14D	Pb-Free 14-Lead Small Outline Package (SOP), EIAJ TYPE II, 5.3mm Wide
74LVX125MTC	MTC14	14-Lead Thin Shrink Small Outline Package (TSSOP), JEDEC MO-153, 4.4mm Wide
74LVX125MTCX_NL (Note 1)	MTC14	Pb-Free 14-Lead Thin Shrink Small Outline Package (TSSOP), JEDEC MO-153, 4.4mm Wide

Devices also available in Tape and Reel. Specify by appending suffix letter "X" to the ordering code.

Pb-Free package per JEDEC J-STD-020B.

Note 1: "_NL" indicates Pb-Free package (per JEDEC J-STD-020B). Device available in Tape and Reel only.

Logic Symbol

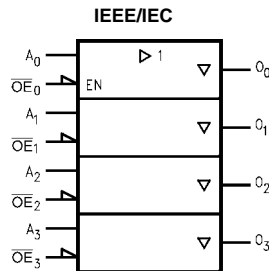

Connection Diagram

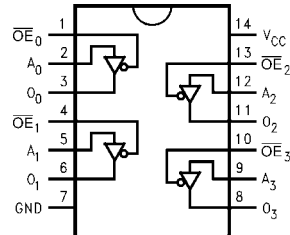

Truth Table

Inputs		Output
\overline{OE}_n	A_n	O_n
L	L	L
L	H	H
H	X	Z

H = HIGH Voltage Level
L = LOW Voltage Level
Z = High Impedance
X = Immaterial

Pin Descriptions

Pin Names	Description
A_n	Inputs
\overline{OE}_n	Output Enable Inputs
O_n	Outputs

Absolute Maximum Ratings (Note 2)

Supply Voltage (V_{CC})	-0.5V to +7.0V
DC Input Diode Current (I_{IK}) $V_I = -0.5V$	-20 mA
DC Input Voltage (V_I)	-0.5V to +7.0V
DC Output Diode Current (I_{OK}) $V_O = 0.5V$	-20 mA
$V_O = V_{CC} + 0.5V$	+20 mA
Output Voltage (V_O)	-0.5V to $V_{CC} + 0.5V$
DC Output Source/Sink Current (I_O)	± 25 mA
DC V_{CC} or Ground Current (I_{CC} or I_{GND})	± 50 mA
Storage Temperature Range (T_{STG})	-65°C to +150°C
Power Dissipation	180 mW

Recommended Operating Conditions (Note 3)

Supply Voltage (V_{CC})	2.0V to 3.6V
Input Voltage (V_I)	0V to 5.5V
Output Voltage (V_O)	0V to V_{CC}
Operating Temperature (T_A)	-40°C to +85°C
Input Rise and Fall Time ($\Delta t/\Delta V$)	0 ns/V to 100 ns/V

Note 2: The "Absolute Maximum Ratings" are those values beyond which the safety of the device cannot be guaranteed. The device should not be operated at these limits. The parametric values defined in the Electrical Characteristics tables are not guaranteed at the absolute maximum ratings. The "Recommended Operating Conditions" table will define the conditions for actual device operation.

Note 3: Unused inputs must be held HIGH or LOW. They may not float.

DC Electrical Characteristics

Symbol	Parameter	V_{CC} (V)	$T_A = 25^\circ C$			$T_A = -40^\circ C$ to $+85^\circ C$		Units	Conditions	
			Min	Typ	Max	Min	Max			
V_{IH}	HIGH Level Input Voltage	2.0	1.5			1.5		V		
		3.0	2.0			2.0				
		3.6	2.4			2.4				
V_{IL}	LOW Level Input Voltage	2.0			0.5		0.5	V		
		3.0			0.8		0.8			
		3.6			0.8		0.8			
V_{OH}	HIGH Level Output Voltage	2.0	1.9	2.0		1.9		V	$V_{IN} = V_{IL}$ or V_{IH}	$I_{OH} = -50 \mu A$ $I_{OH} = -50 \mu A$ $I_{OH} = -4 mA$
		3.0	2.9	3.0		2.9				
		3.0	2.58			2.48				
V_{OL}	LOW Level Output Voltage	2.0		0.0	0.1		0.1	V	$V_{IN} = V_{IL}$ or V_{IH}	$I_{OL} = 50 \mu A$ $I_{OL} = 50 \mu A$ $I_{OL} = 4 mA$
		3.0		0.0	0.1		0.1			
		3.0			0.36		0.44			
I_{OZ}	3-STATE Output Off-State Current	3.6			± 0.25		± 2.5	μA	$V_{IN} = V_{IH}$ or V_{IL} $V_{OUT} = V_{CC}$ or GND	
I_{IN}	Input Leakage Current	3.6			± 0.1		± 1.0	μA	$V_{IN} = 5.5V$ or GND	
I_{CC}	Quiescent Supply Current	3.6			4.0		40.0	μA	$V_{IN} = V_{CC}$ or GND	

Noise Characteristics (Note 4)

Symbol	Parameter	V_{CC} (V)	$T_A = 25^\circ C$		Units	C_L (pF)
			Typ	Limit		
V_{OLP}	Quiet Output Maximum Dynamic V_{OL}	3.3	0.3	0.8	V	50
V_{OLV}	Quiet Output Minimum Dynamic V_{OL}	3.3	-0.3	-0.8	V	50
V_{IHD}	Minimum HIGH Level Dynamic Input Voltage	3.3		2.0	V	50
V_{ILD}	Maximum LOW Level Dynamic Input Voltage	3.3		0.8	V	50

Note 4: Input $t_r = t_f = 3$ ns

AC Electrical Characteristics										
Symbol	Parameter	V _{CC} (V)	T _A = +25°C			T _A = -40°C to +85°C		Units	Conditions	
			Min	Typ	Max	Min	Max			
t _{PLH}	Propagation Delay Time Data to Output	2.7		5.8	10.1	1.0	13.5	ns	C _L = 15 pF	
t _{PHL}				8.3	13.6	1.0	17.0		C _L = 50 pF	
		3.3 ± 0.3			4.4	6.2	1.0		8.5	C _L = 15 pF
						6.9	9.7		1.0	12.0
t _{PZH}	Output Enable Time	2.7		5.3	9.3	1.0	12.5	ns	C _L = 15 pF, R _L = 1 kΩ	
t _{PZL}				7.8	12.8	1.0	16.0		C _L = 50 pF, R _L = 1 kΩ	
		3.3 ± 0.3			4.0	5.6	1.0		7.5	C _L = 15 pF, R _L = 1 kΩ
						6.5	9.1		1.0	11.0
t _{PHZ}	Output Disable Time	2.7		10.0	15.7	1.0	19.0	ns	C _L = 50 pF, R _L = 1 kΩ	
t _{PLZ}			3.3 ± 0.3		8.3	11.2	1.0		13.0	C _L = 50 pF, R _L = 1 kΩ
t _{OSSL}	Output to Output	2.7			1.5		1.5	ns	C _L = 50 pF	
t _{OSLH}	Skew (Note 5)	3.3			1.5		1.5			

Note 5: Parameter guaranteed by design. t_{OSSL} = |t_{PLHm} - t_{PLHnl}|. t_{OSLH} = |t_{PHLm} - t_{PHLnl}|

Capacitance

Symbol	Parameter	T _A = 25°C			T _A = -40°C to +85°C		Units
		Min	Typ	Max	Min	Max	
C _{IN}	Input Capacitance		4.0	10		10	pF
C _{PD}	Power Dissipation Capacitance (Note 6)		14				pF

Note 6: C_{PD} is defined as the value of the internal equivalent capacitance which is calculated from the operating current consumption without load.

Average operating current can be obtained by the equation: $I_{CC(opr.)} = \frac{C_{PD} \times V_{CC} \times f_{IN} + I_{CC}}{4}$ (per bit)

Physical Dimensions inches (millimeters) unless otherwise noted



**14-Lead Small Outline Integrated Circuit (SOIC), JEDEC MS-012, 0.150" Narrow
Package Number M14A**

Physical Dimensions inches (millimeters) unless otherwise noted (Continued)

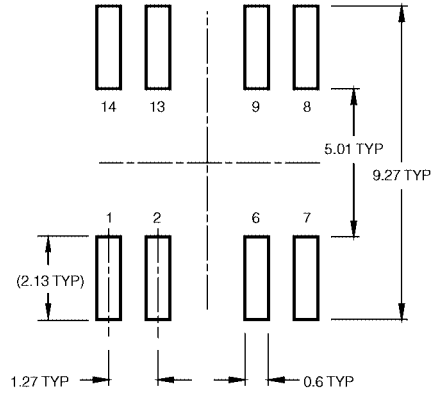
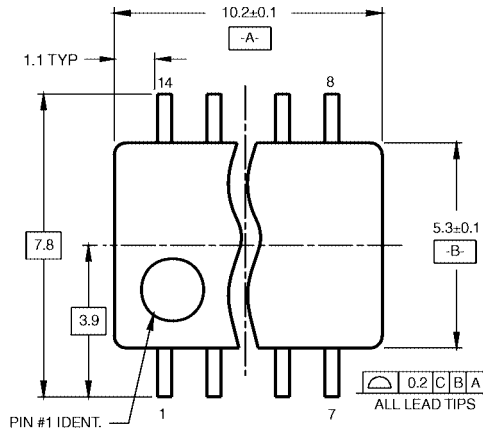

LAND PATTERN RECOMMENDATION

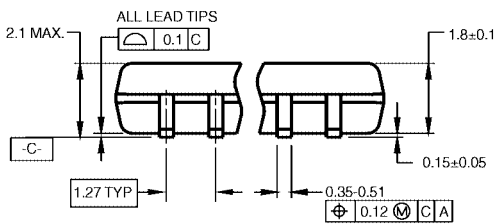

DIMENSIONS ARE IN MILLIMETERS



- NOTES:
 A. CONFORMS TO EIAJ EDR-7320 REGISTRATION, ESTABLISHED IN DECEMBER, 1998.
 B. DIMENSIONS ARE IN MILLIMETERS.
 C. DIMENSIONS ARE EXCLUSIVE OF BURRS, MOLD FLASH, AND TIE BAR EXTRUSIONS.

M14DRevB1

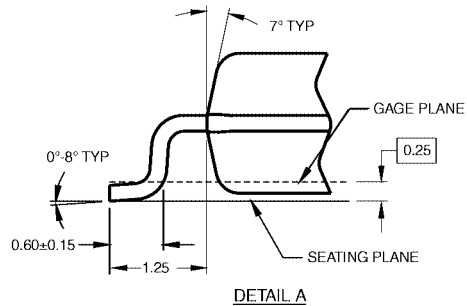

DETAIL A

Pb-Free 14-Lead Small Outline Package (SOP), EIAJ TYPE II, 5.3mm Wide Package Number M14D

Physical Dimensions inches (millimeters) unless otherwise noted (Continued)

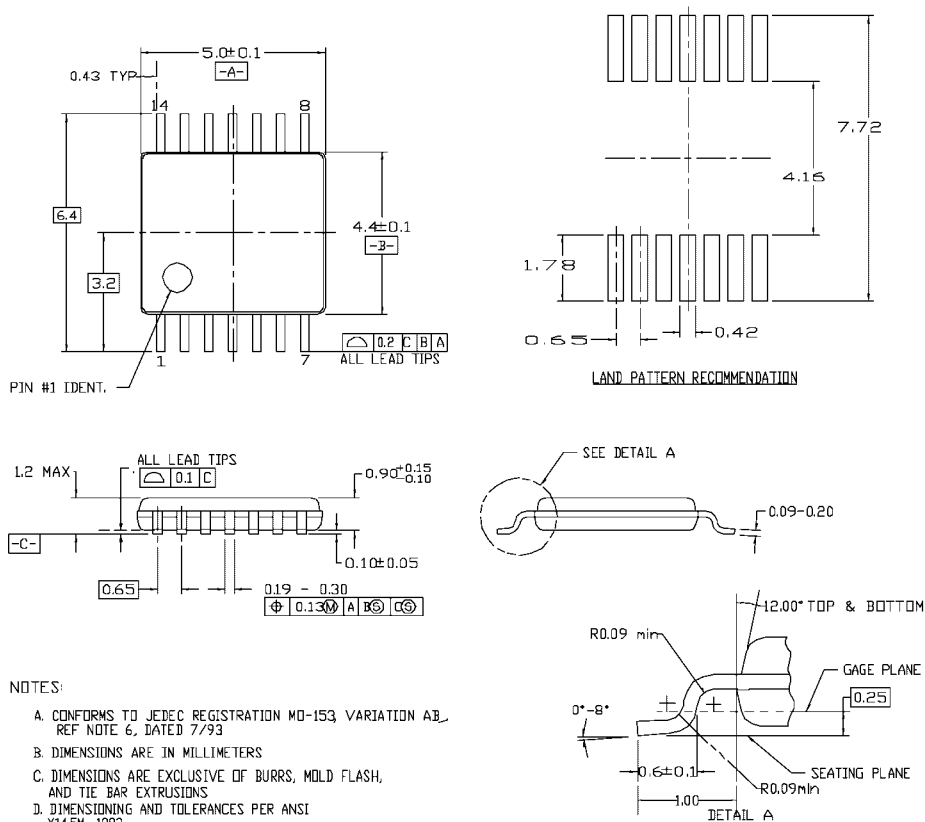

- NOTES:
- A. CONFORMS TO JEDEC REGISTRATION MO-153 VARIATION AB, REF NOTE 6, DATED 7/93
 - B. DIMENSIONS ARE IN MILLIMETERS
 - C. DIMENSIONS ARE EXCLUSIVE OF BURRS, MOLD FLASH, AND TIE BAR EXTRUSIONS
 - D. DIMENSIONING AND TOLERANCES PER ANSI Y14.5M, 1982

MTC14revD

14-Lead Thin Shrink Small Outline Package (TSSOP), JEDEC MO-153, 4.4mm Wide Package Number MTC14

Fairchild does not assume any responsibility for use of any circuitry described, no circuit patent licenses are implied and Fairchild reserves the right at any time without notice to change said circuitry and specifications.

LIFE SUPPORT POLICY

FAIRCHILD'S PRODUCTS ARE NOT AUTHORIZED FOR USE AS CRITICAL COMPONENTS IN LIFE SUPPORT DEVICES OR SYSTEMS WITHOUT THE EXPRESS WRITTEN APPROVAL OF THE PRESIDENT OF FAIRCHILD SEMICONDUCTOR CORPORATION. As used herein:

1. Life support devices or systems are devices or systems which, (a) are intended for surgical implant into the body, or (b) support or sustain life, and (c) whose failure to perform when properly used in accordance with instructions for use provided in the labeling, can be reasonably expected to result in a significant injury to the user.
2. A critical component in any component of a life support device or system whose failure to perform can be reasonably expected to cause the failure of the life support device or system, or to affect its safety or effectiveness.

www.fairchildsemi.com